



národní
úložiště
šedé
literatury

Doktorandské dny '11.

Kuželová, Dana
2011

Dostupný z <http://www.nusl.cz/ntk/nusl-55982>

Dílo je chráněno podle autorského zákona č. 121/2000 Sb.

Tento dokument byl stažen z Národního úložiště šedé literatury (NUŠL).

Datum stažení: 27.09.2024

Další dokumenty můžete najít prostřednictvím vyhledávacího rozhraní nusl.cz .

Doktorandské dny '11

Ústav informatiky AV ČR, v. v. i.

October 5–7, 2011, Jizerka

Proceedings of the XVI. PhD. Conference
Edited by Dana Kuželová and František Hák
Institute of Computer Science
Academy of Sciences of the Czech Republic, v. v. i.

Doktorandské dny '11

Ústav informatiky AV ČR, v. v. i.

Jizerka

5. – 7. říjen 2011

vydavatelství Matematicko-fyzikální fakulty
Univerzity Karlovy v Praze

Ústav informatiky AV ČR, v. v. i., Pod Vodárenskou věží 2, 182 07 Praha 8

Všechna práva vyhrazena. Tato publikace ani žádná její část nesmí být reprodukována nebo šířena v žádné formě, elektronické nebo mechanické, včetně fotokopí, bez písemného souhlasu vydavatele.

© Ústav informatiky AV ČR, v. v. i., 2011
© MATFYZPRESS, vydavatelství Matematicko-fyzikální fakulty
Univerzity Karlovy v Praze 2011

ISBN – *not yet* –

Doktorandské dny Ústavu informatiky AV ČR, v. v. i., se konají nepřetržitě od roku 1996 a poskytují doktorandům, podílejícím se na odborných aktivitách Ústavu informatiky, možnost prezentovat výsledky jejich odborného studia. Současně poskytuje prostor pro oponentní připomínky k přednášené tematice a použité metodologii práce ze strany přítomné odborné komunity.

Z jiného úhlu pohledu, toto setkání doktorandů podává průřezovou informaci o odborném rozsahu pedagogických aktivit, které jsou realizovány na pracovištích či za spoluúčasti Ústavu informatiky.

Jednotlivé příspěvky sborníku jsou uspořádány podle jmen autorů. Uspořádání podle tematického zaměření nepovažujeme vzhledem k rozmanitosti jednotlivých témat za účelné.

Vedení Ústavu informatiky jakožto organizátor doktorandských dnů věří, že toto setkání mladých doktorandů, jejich školitelů a ostatní odborné veřejnosti povede ke zkvalitnění celého procesu doktorandského studia zajišťovaného v součinnosti s Ústavem informatiky a v neposlední řadě k navázání a vyhledání nových odborných kontaktů.

1. září 2011

Obsah / Contents

<i>Lukáš Bajer:</i> Elliptical Copula-Based Estimation of Distribution Algorithms	6
<i>Radim Demut:</i> Different Measures of Reliability in Regression	13
<i>Tomáš Dzetkulič:</i> Incremental Computation of Succinct Abstractions for Hybrid Systems	19
<i>Jana Fürstová:</i> Competing Risks of CML-Related Death and Death from Other Causes	20
<i>Martin Horáček:</i> Traditional Measures of Diversity, Their Estimates and Sensitivity to Changes	28
<i>Anna Horňáková:</i> Data Security in Biomedicine	29
<i>Karel Chvalovský:</i> Notes on Condensed Detachment	35
<i>Ivan Kasanický:</i> Kalmanův filtr a jeho rozšíření na prostorech velké dimenze	41
<i>Ondřej Kazík:</i> Role Model of Hybrid Intelligence and Computational MAS	47
<i>Jaroslav Kezníkl:</i> Obstacles in Modeling of Complex Layered Systems in Alloy	56
<i>Ondřej Konár:</i> Detekce zvýšených ztrát v distribuční síti zemního plynu	63
<i>Jiří Kopal:</i> Analysis of Algebraic Preconditioning Based on Different Variants of the Gram-Schmidt Algorithm	73
<i>Pavel Krč:</i> Subprocess Heuristic for Partially Observable Markov Decision Processes	80

<i>Daniel Kršička:</i> Objektivizace charakteristik integrace infomačních systémů ve zdravotnictví	81
<i>Tomáš Kulhánek:</i> Infrastructure for Data Storage and Computation in Biomedical Research	90
<i>Marie Michenková:</i> Numerical Algorithms for Low-Rank Matrix Completion Problems	95
<i>Jan Papež:</i> Nová zastavovací kritéria pro Cascadic Conjugate Gradient Method	96
<i>Petr Paščenko:</i> The Neural Networks Methodology of the Short-Term Electricity Consumption Forecasting	97
<i>Martin Pilát:</i> Multiobjective Memetic Algorithm with Local Meta-Models	103
<i>Andrej Podzimek:</i> A Portable Read-Copy-Update Algorithm	110
<i>Libor Seidl:</i> Interoperabilita v českém zdravotnictví	112
<i>Dalibor Slovák:</i> Stochastic Approaches to Identification Process in Forensic Medicine and Criminalistics	120
<i>Jaroslav Šťastný:</i> Covariance Matrix Adaptation in Evolution Strategies	126
<i>David Štefka:</i> Interaction-Sensitive Fuzzy Measure in Dynamic Classifier Aggregation: an Experimental Comparison	133
<i>Pavel Tyl:</i> The Heritage Trust Model	143
<i>Martin Víta:</i> Special Types of Filters on Algebras of Rasiowa Implicative Logics	144
<i>Karel Zvára:</i> Strukturální a lexikální analýza lékařských zpráv	145
<i>Miroslav Zvolský:</i> Cardio Online Reader – An Easy Way to Obtain Valid Scientific Articles in Cardiology	149

Elliptical Copula-Based Estimation of Distribution Algorithms

Post-Graduate Student:

MGR. LUKÁŠ BAJER

Faculty of Mathematics and Physics
Charles University in Prague
Malostranské náměstí 25
118 00 Prague 1, CZ

bajer@cs.cas.cz

Supervisor:

DOC. ING. RNDR. MARTIN HOLEŇA,
CSC.

Institute of Computer Science of the ASCR, v. v. i.
Pod Vodárenskou věží 2
182 07 Prague 8, CZ

martin@cs.cas.cz

Field of Study:
Theoretical Computer Science

This work was supported by the Czech Science Foundation (GAČR), grant No. P202/11/1368,
and Grant Agency of the Charles University (GA UK), grant No. 278511/2011.

Abstract

Estimation of distribution algorithms (EDAs) were developed as a novel kind of evolutionary algorithms fifteen years ago. In these algorithms, new populations are generated via sampling of the estimated distribution of solutions with higher fitness values: the model of such a distribution is constructed in each step instead of generating individuals through recombination operators like crossover or mutation. Most of the current EDAs employ graphical probabilistic models which are, however, either computationally very demanding or unrealistic in many real-world applications. Therefore, other kinds of models are appearing. This paper investigates usage of multivariate elliptical copulas as a model of the distribution of feasible solutions.

1. Introduction

Evolutionary algorithms (EAs) which utilize probabilistic or linkage models of dependencies between variables are becoming increasingly popular. Such algorithms, called Estimation of Distribution Algorithms (EDAs) [1] or Probabilistic Model Building Genetic Algorithms (PMBGAs), have many common aspects with the most popular EAs: genetic algorithms. Similarly to them, they evolve a set of promising candidate solutions, a population of individuals. During each generation, a new set of individuals is generated and a part or the former population is replaced according to some selection criterion.

Nevertheless, the new individuals are in EDAs generated differently. Instead of genetic operators like crossover and mutation, EDAs estimate the probability distribution of the most promising solutions, and new populations are obtained by random sampling from this dis-

tribution. The current paper recalls the most important kinds of EDAs and models for estimating the probability distributions while focusing on the recent usage of copulas as a model of distribution, especially multivariate elliptical copulas.

The paper is divided in following sections. In the next section, the general concept of EDAs is briefly presented. The third section gives a short overview of the different variants of EDAs, and the Section 4 is focused on utilizing of elliptical copulas as a probabilistic model. In the last section, two experiments evaluating the proposed solution are described.

2. Basic principles of EDAs

The majority of both the EAs and EDAs are rather similar. The general pseudo-code of EDAs is outlined in Fig. 1. Here, steps (1), (2) and (3) are the same as in many evolutionary algorithms while steps (4) and (5) are typical particularly for EDAs.

- 1: $P_0 \leftarrow$ randomly generate m individuals
- 2: **for** $k = 1, 2, \dots$ until a stopping criterion is met **do**
- 3: $pool \leftarrow$ select $n \leq m$ individuals from P_{k-1} according to the selection method
- 4: $p_l(\mathbf{x}) = p(\mathbf{x} \mid pool) \leftarrow$ estimate the probability distribution of an individual based on the selected individuals (in $pool$)
- 5: $P_l \leftarrow$ sample new population from $p_l(\mathbf{x})$
- 6: **end for**

Figure 1: Estimation of distribution algorithm.

The main difference between EDAs and EAs lies in the method how they generate new individuals according to the previous generation. Whereas traditional EAs, for example genetic algorithms, try to implicitly combine

building blocks representing promising parts of genetic code of already found good solutions by genetic operations (crossover, mutation) [2], EDAs try to find correlations among variables in an explicit way.

The probabilistic distribution of the input variables is estimated. In the following text, the term *model* will represent a formal framework for estimating the joint probability distribution of individuals. Having this model, generating new individuals is relatively easy. However, estimating of the distribution with the model is often a bottleneck of EDAs; especially when the problem being solved is hard and complex dependencies among variables have to be determined.

2.1. Probabilistic graphical models

The majority of present EDAs estimate the probability distribution with probabilistic graphical models [1, 3]. These models make use of a directed acyclic graphs (DAG) where each node corresponds to one input variable X_i , and the arcs define dependencies between variables.

Further, the models consist of a set of unconditional probabilities for all root nodes of the graph $\rho(X_i = x_i | \emptyset)$, and a set of conditional probabilities for other nodes, given values of their respective parents \mathbf{Pa}_i : $\rho(X_i = x_i | \mathbf{pa}_i)$. Here, ρ denotes *generalized probability distribution* which stands for *mass probability* $p(X_i = x_i^k)$ for discrete random variables and *density function* $f(x_i)$ for continuous X_i .

From the conditional (in)dependence defined by the DAG, the factorization of the joint probability distribution of the variables can be expressed as

$$\rho(x_1, \dots, x_n | \theta_S) = \prod_{i=1}^n \rho(x_i | \mathbf{pa}_i^S, \theta_i). \quad (1)$$

The most frequent representatives of probabilistic graphical models are Bayesian networks for discrete variables and Gaussian networks for continuous variables. While in case of Bayesian networks the joint probability distribution can be written analogically to (1), Gaussian networks use the density function of normal distribution with nontrivial parameters

$$f(x_1, \dots, x_n | \theta_S) = \prod_{i=1}^n \phi(x_i) \phi(x_i) \sim N(m_i + \sum_{x_j \in \mathbf{Pa}_i} b_{ji}(x_j - m_j), v_i). \quad (2)$$

The parameter m_i denotes unconditional mean of X_i , b_{ji} is a linear coefficient reflecting the strength of relationship between variables X_j and X_i , and v_i is the variance of X_i given \mathbf{Pa}_i .

3. Current variants of EDAs

Today's variants of EDAs can be distinguished according to complexity of interactions among variables, and different variants for discrete and continuous variables have been developed.

The simplest algorithms consider all the variables independent. For discrete dimensions PBIL [4], UMDA [5] and cGA [6] exist, UMDA_c is a continuous variant of the second one.

Algorithms whose variables are able to depend on one predecessor are, for example, MIMIC [7], COMIT [8], or BMDA [9].

Multiple dependencies are able to be expressed by BOA (Bayesian Estimation Algorithm) and its variants [10] – probably the most vividly developing discrete EDA today. Other multiple-dependencies-EDAs are, for example, EBNA [11] or FDA [12]. Continuous versions are rather few but some of them exist: EGNA [13] or rBOA [14].

4. Copulas as a probabilistic model for EDAs

The major motivation of usage of copulas in EDAs lies in their simplicity and ability of expressing others than gaussian joint distributions. A *copula* is a function which connects two or more uniformly distributed variables together

$$C(u_1, u_2, \dots, u_n), \quad u_i \sim U(0, 1). \quad (3)$$

Instead of uniformly distributed u_1, \dots, u_n , univariate inverse marginal distribution functions of arbitrary variables can be used. This usage forms a joint multivariate distribution of these variables, as it is described by Sklar's theorem (see eqn. (4)).

More formally, the copula is a function $C : [0, 1]^n \rightarrow [0, 1]$ satisfying following conditions:

1. $C(x_1, \dots, x_n) = 0$ whenever $\exists i : x_i = 0$,
2. $C(x_1, \dots, x_n) = x_j$ whenever $\forall i \neq j : x_i = 1$, and
3. $C(x_1, \dots, x_n)$ is n -increasing (see [15] for details).

Especially from the condition (b) follows that all the copula function have uniformly distributed marginals.

The important result of the Sklar's theorem [15] is that for any given joint distribution function $H(x_1, \dots, x_n)$

with marginals $F_1(x_1), \dots, F_n(x_n)$, there exists an n -copula C such that for all $(x_1, \dots, x_n) \in [\mathbb{R} \cup \{-\infty, \infty\}]^n$

$$H(x_1, \dots, x_n) = C(F_1(x_1), \dots, F_n(x_n)). \quad (4)$$

Expressing or estimating marginal distributions $F_1(x_1), \dots, F_n(x_n)$ from data is relatively easy. However, as the true distribution function H is usually unknown and the Sklar's theorem gives only existence of the copula C , the correct variant of the copula function and its parameters have to be estimated.

Employing of copulas in EDAs appeared in the literature only recently [16–19]. Most of these publications use only bivariate copulas which are differently connected forming a multivariate distribution function.

Several kinds of copulas are distinguished in the literature. The most famous are elliptical and Archimedean families. While for the multivariate elliptical copulas (primarily Gaussian and t -copulas) conventional maximum-likelihood (ML) based methods for parameter estimation exist, estimation and sampling of multivariate Archimedean copulas require either hierarchical approach of nesting, or method using Laplace transforms ([20], p. 67).

4.1. Elliptical copulas

The well-known member of the elliptical family is the Gaussian copula

$$C(u_1, \dots, u_n; \rho) = \Phi_\rho(\Phi^{-1}(u_1), \dots, \Phi^{-1}(u_n)) \quad (5)$$

with multivariate normal (cumulative) distribution function (CDF) Φ_ρ (described by a covariance matrix ρ) and inverses of univariate normal CDFs Φ^{-1} . Gaussian copulas attained their attention, for example, in financial sector as a mean of modelling risks [21], although the true contribution in this area is disputable [22].

The second example of this elliptical family is the t -copula which has very similar structure, but instead of normal, Student's t -distribution is used.

4.2. Gaussian and t -copula-based EDA

Using copulas as a probabilistic model for EDAs requires (a) a method for estimating marginal distributions, (b) a method for fitting proper kind of copula on the data (previously transformed by their corresponding inverse marginal distribution functions), and (c) a method for generating individuals from the fitted copula. The crucial advantage of using copulas is that parts (a) and (b) can be performed independently.

As was stated above, standard methods for (a) estimating marginal distributions and (b) fitting Gaussian and t -copula have already existed. In our experiment, empirical estimation smoothed via kernels was used for marginals, and ML estimates served for assessing parameters of the copulas.

Having the marginal distributions and the parameters of the multivariate Gaussian or Student's t -distribution, sampling (c) from these multivariate distributions is well-studied, too. All the steps are summarized in Fig. 2.

- 1: **Input:** matrix $X \in \mathbf{R}^{n \times p}$ of selected individuals
 m – the number of individuals to generate
- 2: $F_1(x_1), \dots, F_p(x_p) \leftarrow$ estimate marginal distribution functions (CDFs) of p columns of X and their inverses $F_1^{-1}, \dots, F_p^{-1}$
- 3: covert x_1, \dots, x_p to $U(0, 1)$ using inverse CDFs:
 $(u_1, \dots, u_p) \leftarrow (F_1^{-1}(x_1), \dots, F_p^{-1}(x_p))$
- 4: $U \leftarrow (u_1 \cdots u_p)$
- 5: **if** Gaussian copula **then**
- 6: $\rho \leftarrow$ estimate covariance matrix of normal CDF from the matrix U
- 7: randomly generate m samples $(s_1, \dots, s_m) \sim \Phi(0, \rho)$
- 8: **else if** Student's t -copula **then**
- 9: $(\Sigma, d_f) \leftarrow$ estimate Σ and the degree of freedom d_f of t -distribution from the matrix U
- 10: randomly generate m samples (s_1, \dots, s_m) from t -distribution
- 11: **end if**
- 12: $S \leftarrow \begin{pmatrix} s_1 \\ \vdots \\ s_m \end{pmatrix}$
- 13: $(y_1, \dots, y_m) \leftarrow (F_1(S_{\cdot,1}), \dots, F_p(S_{\cdot,p}))$
- 14: **return** (y_1, \dots, y_m)

Figure 2: Estimation and sampling from Gaussian and t -copula.

5. Experiments

5.1. Aerospace trajectory optimization problem

The described copula learning and sampling algorithm has been implemented in Matlab environment using Statistical toolbox, and this part was integrated with Mateda toolbox [23] which provides implementations of several EDAs.

As a test function, we have chosen a ‘‘SAGAS’’ problem from GTOP Database [24] – a black-box optimization problem of finding the best trajectory for a spacecraft equipped with a chemical propulsion. The results of Copula-based EDA (CEDA) with Gaussian and

t -copula and comparison with EDA based on Gaussian networks are in Tab. 1 (EDA with mixture of Gaussians and EGNA). The objective values in the table represent consumption of the spacecraft – the lower number the better. All the experiments used a population of size 1000 and ran for 30 generations.

	Gaussian CEDA	t -copula CEDA	mixture of Gauss. EDA	EGNA	GA
mean	1340.7	1341.8	1406.1	1401.5	1440.1
st. dev.	103.1	143.4	133.9	116.9	203.1

Table 1: Experimental results: the best achieved objective values after 30 generations, average results from 30 runs of algorithms.

The results in the table show that copula-based EDAs outperformed not only a genetic algorithm, but EDA with mixture of Gaussians – standard method provided for this task in the Mateda toolbox – and EGNA – another common EDA with arbitrary Gaussian networks (which are learned very slowly). Further, Gaussian copulas give more stable results than t -copula. Average progress of the best objective values in the first 30 generations are in Fig. 3.

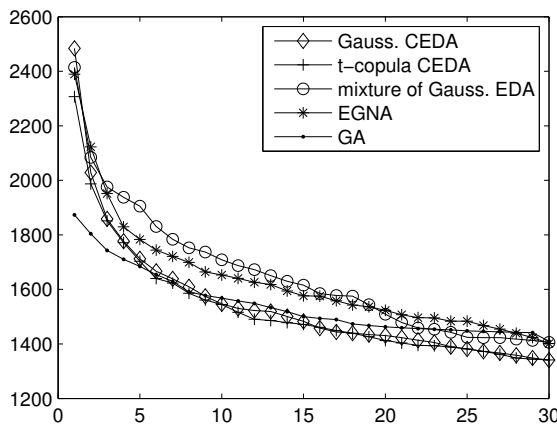

Figure 3: Best objective function progress in first 30 generations.

5.2. COCO – Comparing Continuous Optimizers

The proposed CEDA algorithm has been tested on several non-noisy benchmark functions from COCO – platform for comparison of real-parameter global black-box optimizers [25], namely Sphere (1), Skew Rastrigin-Bueche separable function (4), original Rosenbrock (8), Sharp ridge (13), Schaffer F7 with asymmetric x -transformation (17) and Schwefel $x \sin(x)$

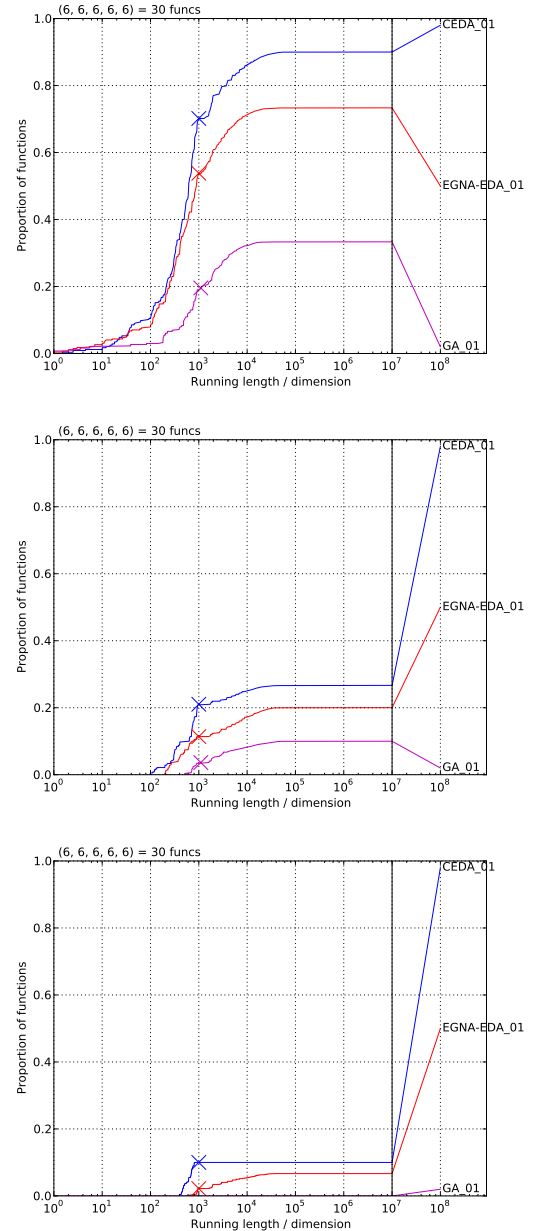

Figure 4: Proportions of functions/function settings (vertical axis) being able to reach f_{target} in given Expected Running Times with respect to the dimension (ERT/ D , horizontal axis), average results for all testing functions; graphs corresponds (from top) to 2, 5 and 10-dimensional inputs respectively.

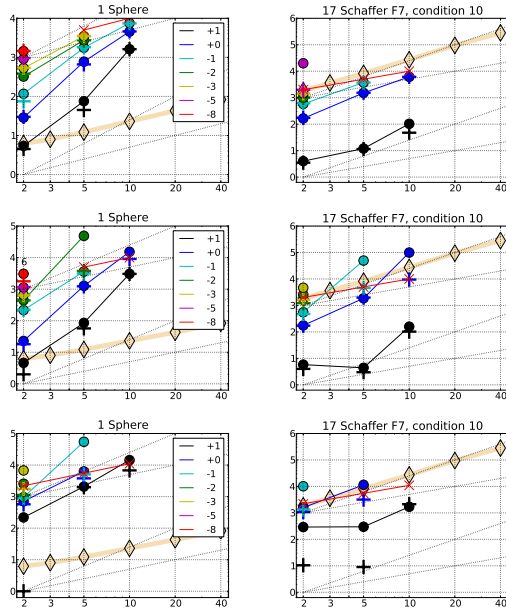

Figure 5: Expected running time (ERT) divided by dimension versus dimension in log-log presentation. First row: CEDA, second row: EGNA, third row: GA. Shown are different target values $f_{\text{opt}} + \Delta f$, where $\Delta f = 10^{\{+1, 0, -1, -2, -3, -5, -8\}}$ and the exponent is given in the legend of f_1 . Plus symbols (+) show the median number of f -evaluations for the best reached target value. Crosses (×) indicate the total number of f -evaluations ($\#FEs(-\infty)$) divided by the number of trials. Numbers above ERT-symbols indicate the number of successful trials. Y-axis annotations are decimal logarithms. The thick light line with diamond markers shows the single best results from BBOB 2009 for $\Delta f = 10^{-8}$.

with tridiagonal transformation (20, the numbers indicate the numbers of function in the COCO platform). Three different algorithms were used for optimization of each function: CEDA (with Gaussian copula), EGNA (both utilizing Mateda toolbox in Matlab) and a standard continuous Matlab implementation of GA with phenotype encoding. All the algorithms used the same population sizes and stopping criteria. Optimization was performed 10-times with each settings, on $D = \{2, 5, 10\}$ dimensions with random uniform initialization on the interval $[-5, 5]^D$.

Following the methodology suggested in COCO, as the main measure for assessing the performance of the algorithms, *expected running time* (ERT) was used – the expected number of objective *function evaluations* (FE) needed to reach a given target function value f_{target} with respect to the actual dimension D . Multiple target objective values are considered: having the optimal value for each function settings f_{opt} , the target values (for minimization) are

$$f_{\text{target}} = f_{\text{opt}} + \Delta f, \quad \Delta f \in \{10^3, 10^2, \dots, 10^{-8}\}.$$

Average expected running times with respect to the dimensions for the Sphere function are recorded in Tab. 2. Graphical evaluation of average results for all six functions gives Fig. 4, ERTs for the Sphere and Schaffer function are depicted in Fig. 5.

1 Sphere												
Δf_{target}	1e+03	1e+02	1e+01	1e+00	1e-01	1e-02	1e-03	1e-04	1e-05	1e-07	Δf_{target}	
ERT _{best} /D	0.10	0.13	161	457	751	∞	∞	∞	∞	∞	ERT _{best} /D	
CEDA	1	3.8	1	1	1	<i>17e-3/1e3</i>	CEDA	
EGNA	1	3.2	1.9	3.3	<i>85e-2/1e3</i>	EGNA	
GA	1	1	8.9	<i>62e-1/1e3</i>	GA	

1 Sphere												
Δf_{target}	1e+03	1e+02	1e+01	1e+00	1e-01	1e-02	1e-03	1e-04	1e-05	1e-07	Δf_{target}	
ERT _{best} /D	0.20	0.20	15	155	353	550	694	1009	∞	∞	ERT _{best} /D	
CEDA	1	1	1	1	1	1	1	1	<i>45e-6/1e3</i>	.	CEDA	
EGNA	1	1.2	1.1	1.6	2.1	18	<i>36e-3/1e3</i>	.	.	.	EGNA	
GA	1	1	28	8.1	31	<i>43e-2/1e3</i>	GA	

1 Sphere												
Δf_{target}	1e+03	1e+02	1e+01	1e+00	1e-01	1e-02	1e-03	1e-04	1e-05	1e-07	Δf_{target}	
ERT _{best} /D	0.50	0.50	2.3	11	58	162	265	356	458	626	ERT _{best} /D	
CEDA	1	1	1.2	1.3	1	1	1	1	1	1	CEDA	
EGNA	1	1	1	1	1.9	1.4	1.2	1.2	1.2	1.5	EGNA	
GA	1	1	48	31	8.2	7.9	13	30	<i>54e-4/1e3</i>	.	GA	

Table 2: Running time excess ERT/ERT_{best} on f_1 (Sphere function), in italics is given the median final function value and the median number of function evaluations to reach this value divided by the dimension.

6. Conclusion

The most important types of estimation of distribution algorithms were described in this paper; a special emphasis has been given on usage of copulas as a novel kind of probabilistic model, forming a “copula-based” EDA – CEDA.

Performance of the proposed algorithms were tested on a well-studied benchmark problem of aerospace trajectory as well as COCO optimization platform. Copula-based EDAs slightly outperformed traditional EDAs as well as the standard genetic algorithm.

References

- [1] P. Larrañaga and J. A. Lozano, *Estimation of distribution algorithms: A new tool for evolutionary computation*. Kluwer, 2002.
- [2] D. E. Goldberg, *Genetic algorithms in search, optimization, and machine learning*. Addison-Wesley, Jan. 1989.
- [3] S. L. Lauritzen, *Graphical models*. Oxford University Press, 1996.
- [4] S. Baluja, “Population-based incremental learning: A method for integrating genetic search based function optimization and competitive learning,” Tech. Rep. Tech. Rep. No. CMU-CS-94-163, Carnegie Mellon University, Pittsburgh, 1994.
- [5] H. Mühlenbein and G. Paass, “From recombination of genes to the estimation of distributions I. binary parameters,” in *Parallel Problem Solving from Nature IV*, pp. 178-187, 1996.
- [6] G. R. Harik, F. G. Lobo, and D. E. Goldberg, “The compact genetic algorithm,” in *Proceeding of the International Conference on Evolutionary Computation (IECE)*, pp. 523-528, IEEE New York, 1998.
- [7] J. S. De Bonet, C. L. Isbell, and P. Viola, “MIMIC: finding optima by estimating probability densities,” *Advances in neural information processing systems*, pp. 424-430, 1997.
- [8] S. Baluja and S. Davies, “Combining multiple optimization runs with optimal dependency trees,” Tech. Rep. Tech. Report CMU-CS-97-157, Carnegie Mellon University, School of Computer Science, 1997.
- [9] M. Pelikan and H. Mühlenbein, “The bivariate marginal distribution algorithm,” *Advances in Soft Computing-Engineering Design and Manufacturing*, pp. 521-535, 1999.
- [10] M. Pelikan and D. Goldberg, “Hierarchical bayesian optimization algorithm,” in *Scalable Optimization via Probabilistic Modeling*, pp. 63–90, 2006.
- [11] R. Etxeberria and P. Larrañaga, “Global optimization with bayesian networks,” in *Second Symposium on Artificial Intelligence (CIMA-99)*, pp. 332-339, 1999.
- [12] H. Mühlenbein, T. Mahnig, and A. O. Rodriguez, “Schemata, distributions and graphical models in evolutionary optimization,” *Journal of Heuristics*, Vol. 5, No. 2, pp. 215-247, 1999.
- [13] P. Larrañaga, R. Etxeberria, J. A. Lozano, and J. M. Pena, “Optimization by learning and simulation of bayesian and gaussian networks,” Tech. Rep. EHU-KZAAIK-4, University of the Basque Country, 1999.
- [14] C. W. Ahn, “Real-coded bayesian optimization algorithm,” in *Advances in Evolutionary Algorithms*, pp. 85-124, 2004.
- [15] R. B. Nelsen, *An Introduction to Copulas*. Springer Verlag, 2006.
- [16] A. Cuesta-Infante, R. Santana, J. Hidalgo, C. Bielza, and P. Larrañaga, “Bivariate empirical and n-variate archimedean copulas in estimation of distribution algorithms,” in *Evolutionary Computation (CEC), 2010 IEEE Congress on*, pp. 1-8, 2010.
- [17] R. Salinas-Gutiérrez, A. Hernández-Aguirre, and E. R. Villa-Diharce, “Dependence trees with copula selection for continuous estimation of distribution algorithms,” in *Proc. of the Genetic and Evolutionary Computation Conference (GECCO '11)*, (Dublin, Ireland), July 2011.
- [18] L. F. Wang and Zeng, “Estimation of distribution algorithm based on copula theory,” *Exploitation of Linkage Learning in Evolutionary Algorithms*, pp. 139-162, 2010.
- [19] L. F. Wang, J. C. Zeng, and Y. Hong, “Estimation of distribution algorithm based on copula theory,” in *Proceedings of the Eleventh conference on Congress on Evolutionary Computation*, pp. 1057-1063, 2009.
- [20] M. Hofert, *Sampling Nested Archimedean Copulas with Applications to CDO Pricing*. PhD thesis, Faculty of Mathematics and Economics, Ulm University, 2010.
- [21] D. Li, “On Default Correlation: A Copula Function Approach,” *Journal of Fixed Income*, Vol. 9, No. 4, pp. 43-54, 2000.

- [22] A. Lipton and A. Rennie, *Credit correlation: life after copulas*. World Scientific, 2007.
- [23] R. Santana, C. Echegoyen, A. Mendiburu, C. Bielza, J. A. Lozano, P. Larranaga, R. Armananzas, and S. Shakya, “MATEDA: a suite of EDA programs in matlab,” Tech. Rep. EHU-KZAA-1K-2/09, University of the Basque Country, Feb. 2009.
- [24] T. Vinkó and D. Izzo, “Global optimisation heuristics and test problems for preliminary spacecraft trajectory design,” Technical report GOHTPPSTD, European Space Agency, the Advanced Concepts Team, 2008.
- [25] N. Hansen, A. Auger, S. Finck, and R. Ros, “Real-parameter black-box optimization benchmarking bbob-2010: Experimental setup,” Tech. Rep. RR-7215, INRIA, 2010.

Different Measures of Reliability in Regression

Post-Graduate Student:

ING. RADIM DEMUT

Department of Mathematics
Faculty of Nuclear Science and Physical Engineering
Czech Technical University
Trojanova 13
120 00 Prague 2, CZ

demut@seznam.cz

Supervisor:

DOC. ING. RNDR. MARTIN HOLEŇA,
CSC.

Institute of Computer Science of the ASCR, v. v. i.
Pod Vodárenskou věží 2
182 07 Prague 8, CZ

martin@cs.cas.cz

Field of Study:
Mathematical Engineering

Abstract

This paper is concerned with the reliability of individual predictions in regression. For this purpose we describe conformal predictors and some methods for estimating the reliability of individual predictions such as sensitivity analysis or local modeling of prediction error. Finally we carry out a simulation to compare the methods in an experiment.

1. Introduction

This paper is concerned with the reliability of predictions in regression models. In the first section we are interested in conformal predictors, which for every confidence level $1 - \varepsilon$ output a prediction set. The conformal predictors should be valid in the sense that in the long run the frequency of error does not exceed ε at each confidence level $1 - \varepsilon$ and the prediction set is as small as possible. The second chapter describes different approaches to estimate the reliability of individual predictions in regression such as sensitivity analysis or local modeling of prediction error. In the third chapter a simulation study comparing different reliability estimates is introduced.

2. Conformal prediction

We assume that we have successive pairs

$$(x_1, y_1), (x_2, y_2), \dots, \quad (1)$$

called examples. Each example (x_i, y_i) consists of an object x_i and its label y_i . The objects are elements of a measurable space \mathbf{X} called the object space and the labels are elements of a measurable space \mathbf{Y} called the label space. Moreover we assume that \mathbf{X} is non-empty

and that the σ -algebra on \mathbf{Y} is different from $\{\emptyset, \mathbf{Y}\}$. We denote $z_i := (x_i, y_i)$ and we set

$$\mathbf{Z} := \mathbf{X} \times \mathbf{Y} \quad (2)$$

and call \mathbf{Z} the example space. Thus the infinite data sequence (1) is an element of the measurable space \mathbf{Z}^∞ .

Our standard assumption is that the examples are chosen independently from some probability distribution Q on \mathbf{Z} , that means the infinite data sequence (1) is drawn from the power probability distribution Q^∞ on \mathbf{Z}^∞ . Usually we need only slightly weaker assumption that the infinite data sequence (1) is drawn from a distribution P on \mathbf{Z}^∞ that is exchangeable, that means that for every $n \in \mathbb{N}$, every permutation π of $\{1, \dots, n\}$, and every measurable set $E \subseteq \mathbf{Z}^\infty$ hold

$$P\{(z_1, z_2, \dots) \in \mathbf{Z}^\infty : (z_1, \dots, z_n) \in E\} = \\ P\{(z_1, z_2, \dots) \in \mathbf{Z}^\infty : (z_{\pi(1)}, \dots, z_{\pi(n)}) \in E\}$$

We denote \mathbf{Z}^* the set of all finite sequences of elements of \mathbf{Z} , \mathbf{Z}^n the set of all sequences of elements of \mathbf{Z} of length n . The order in which old examples appear should not make any difference. In order to formalize this point we need the concept of a bag. A bag of size $n \in \mathbb{N}$ is a collection of n elements some of which may be identical. To identify a bag we must say what elements it contains and how many times each of these elements is repeated. We write $\setminus z_1, \dots, z_n /$ for the bag consisting of elements z_1, \dots, z_n , some of which may be identical with each other. We write $\mathbf{Z}^{(n)}$ for the set of all bags of size n of elements of a measurable space \mathbf{Z} . The set $\mathbf{Z}^{(n)}$ is itself a measurable space. It can be defined formally as the power space \mathbf{Z}^n with a nonstandard σ -algebra, consisting of measurable subsets of \mathbf{Z}^n that contain all permutations of their elements. We write $\mathbf{Z}^{(*)}$ for the set of all bags of elements of \mathbf{Z} .

2.1. Confidence predictors

We assume that at the n th trial we have firstly only the object x_n and only later we get the label y_n . If we simply want to predict y_n , then we need a function

$$D : \mathbf{Z}^* \times \mathbf{X} \rightarrow \mathbf{Y}. \quad (3)$$

We call such a function a simple predictor, always assuming it is measurable. For any sequence of old examples $x_1, y_1, \dots, x_{n-1}, y_{n-1} \in \mathbf{Z}^*$ and any new object x_n , it gives $D(x_1, y_1, \dots, x_{n-1}, y_{n-1}, x_n) \in \mathbf{Y}$ as its prediction for the new label y_n .

Instead of merely choosing a single element of \mathbf{Y} as our prediction for y_n , we want to give subsets of \mathbf{Y} large enough that we can be confident that y_n will fall in them, while also giving smaller subsets in which we are less confident. An algorithm that predicts in this sense requires additional input $\varepsilon \in (0, 1)$, which we call significance level, the complementary value $1 - \varepsilon$ is called confidence level. Given all these inputs

$$x_1, y_1, \dots, x_{n-1}, y_{n-1}, x_n, \varepsilon \quad (4)$$

an algorithm Γ that interests us outputs a subset

$$\Gamma^\varepsilon(x_1, y_1, \dots, x_{n-1}, y_{n-1}, x_n) \quad (5)$$

of \mathbf{Y} . We require this subset to shrink as ε is increased that means it holds

$$\begin{aligned} \Gamma^{\varepsilon_1}(x_1, y_1, \dots, x_{n-1}, y_{n-1}, x_n) &\subseteq \\ \Gamma^{\varepsilon_2}(x_1, y_1, \dots, x_{n-1}, y_{n-1}, x_n) &\end{aligned} \quad (6)$$

whenever $\varepsilon_1 \geq \varepsilon_2$.

Formally, we call a measurable function

$$\Gamma : \mathbf{Z}^* \times \mathbf{X} \times (0, 1) \rightarrow 2^{\mathbf{Y}} \quad (7)$$

that satisfies (6) for all $n \in \mathbb{N}$, all incomplete data sequences $x_1, y_1, \dots, x_{n-1}, y_{n-1}, x_n$ and all significance levels $\varepsilon_1 \geq \varepsilon_2$ a confidence predictor.

We now introduce a formal notation for the errors Γ makes when it processes the data sequence

$$\omega = (x_1, y_1, x_2, y_2, \dots) \quad (8)$$

at significance level ε . Whether Γ makes an error on the n th trial can be represented by a number that is one in case of an error and zero in case of no error

$$\text{err}_n^\varepsilon(\Gamma, \omega) := \begin{cases} 1 & \text{if } y_n \notin \Gamma^\varepsilon(x_1, y_1, \dots, \\ & x_{n-1}, y_{n-1}, x_n), \\ 0 & \text{otherwise,} \end{cases} \quad (9)$$

and the number of errors during the first n trials is

$$\text{Err}_n^\varepsilon(\Gamma, \omega) := \sum_{i=1}^n \text{err}_i^\varepsilon(\Gamma, \omega) \quad (10)$$

If ω is drawn from an exchangeable probability distribution P , the number $\text{err}_n^\varepsilon(\Gamma, \omega)$ is the realized value of a random variable, which we may designate $\text{err}_n^\varepsilon(\Gamma, P)$. We say that confidence predictor is exactly valid if for each ε

$$\text{err}_1^\varepsilon(\Gamma, P), \text{err}_2^\varepsilon(\Gamma, P), \dots \quad (11)$$

is a sequence of independent Bernoulli random variables with parameter ε .

The confidence predictor Γ is conservatively valid if for any exchangeable probability distribution P on \mathbf{Z}^∞ there exists a probability space with two families

$$(\xi_n^{(\varepsilon)} : \varepsilon \in (0, 1), n = 1, 2, \dots) \quad (12)$$

and

$$(\eta_n^{(\varepsilon)} : \varepsilon \in (0, 1), n = 1, 2, \dots) \quad (13)$$

of $\{0, 1\}$ -valued variables such that

- for a fixed ε , $\xi_1^{(\varepsilon)}, \xi_2^{(\varepsilon)}, \dots$ is a sequence of independent Bernoulli random variables with parameter ε ;
- for all n and ε , $\eta_n^{(\varepsilon)} \leq \xi_n^{(\varepsilon)}$;
- the joint distribution of $\text{err}_n^\varepsilon(\Gamma, P)$, $\varepsilon \in (0, 1)$, $n = 1, 2, \dots$, coincides with the joint distribution of $\eta_n^{(\varepsilon)}$, $\varepsilon \in (0, 1)$, $n = 1, 2, \dots$

To obtain exact validity we define randomized confidence predictor as a measurable function

$$\Gamma : (\mathbf{X} \times [0, 1] \times \mathbf{Y})^* \times (\mathbf{X} \times [0, 1]) \times (0, 1) \rightarrow 2^{\mathbf{Y}} \quad (14)$$

which, for all significance levels $\varepsilon_1 \geq \varepsilon_2$, all positive integer n , and all incomplete data sequences

$$x_1, \tau_1, y_1, \dots, x_{n-1}, \tau_{n-1}, y_{n-1}, x_n, \tau_n, \quad (15)$$

where $x_i \in \mathbf{X}$, $\tau_i \in [0, 1]$ and $y_i \in \mathbf{Y}$ for all i satisfies

$$\begin{aligned} \Gamma^{\varepsilon_1}(x_1, \tau_1, y_1, \dots, x_{n-1}, \tau_{n-1}, y_{n-1}, x_n, \tau_n) &\subseteq \\ \Gamma^{\varepsilon_2}(x_1, \tau_1, y_1, \dots, x_{n-1}, \tau_{n-1}, y_{n-1}, x_n, \tau_n). &\end{aligned} \quad (16)$$

We will always assume that τ_1, τ_2, \dots are random numbers independently drawn from uniform distribution on $[0, 1]$. We define $\text{err}_n^\varepsilon(\Gamma, \omega)$ by (9) with x_i now being extended objects $x_i \in \mathbf{X} \times [0, 1]$ and $\text{Err}_n^\varepsilon(\Gamma, \omega)$ is defined by (10) as before.

2.2. Conformal predictors

A nonconformity measure is a measurable mapping

$$A : \mathbf{Z}^{(*)} \times \mathbf{Z} \rightarrow \overline{\mathbb{R}}. \quad (17)$$

To each possible bag of old examples and each possible new example, A assigns a numerical score indicating how different the new example is from the old ones. It is sometimes convenient to consider separately how a nonconformity measure deals with bags of different sizes. If A is a nonconformity measure, for each $n = 1, 2, \dots$ we define the function

$$A_n : \mathbf{Z}^{(n-1)} \times \mathbf{Z} \rightarrow \overline{\mathbb{R}} \quad (18)$$

as the restriction of A to $\mathbf{Z}^{(n-1)} \times \mathbf{Z}$. The sequence $(A_n : n \in \mathbb{N})$, which we abbreviate to (A_n) will also be called a nonconformity measure.

Given a nonconformity measure (A_n) and a bag $\setminus z_1, \dots, z_n /$ we can compute the nonconformity score

$$\alpha_i := A_n(\setminus z_1, \dots, z_{i-1}, z_{i+1}, \dots, z_n /, z_i) \quad (19)$$

for each example z_i in the bag. Because a nonconformity measure (A_n) may be scaled however we like, the numerical value of α_i does not, by itself, tell us how unusual (A_n) finds z_i to be. For that we define p-value for z_i as

$$\frac{|\{j = 1, \dots, n : \alpha_j \geq \alpha_i\}|}{n}. \quad (20)$$

The conformal predictor defined by a nonconformity measure (A_n) is the confidence predictor Γ obtained by setting

$$\Gamma^\varepsilon(x_1, y_1, \dots, x_{n-1}, y_{n-1}, x_n) \quad (21)$$

equal to the set of all labels $y \in \mathbf{Y}$ such that

$$\frac{|\{i = 1, \dots, n : \alpha_i \geq \alpha_n\}|}{n} > \varepsilon, \quad (22)$$

where

$$\begin{aligned} \alpha_i &:= A_n(\setminus (x_1, y_1), \dots, (x_{i-1}, y_{i-1}), \\ &\quad (x_{i+1}, y_{i+1}), \dots, (x_{n-1}, y_{n-1}), (x_n, y) /, \\ &\quad (x_i, y_i)), \quad \forall i = 1, \dots, n-1, \\ \alpha_n &:= A_n(\setminus (x_1, y_1), \dots, (x_{n-1}, y_{n-1}) /, (x_n, y)) \end{aligned}$$

Proofs of the next two theorems can be found in [2].

Theorem 2.1 *All conformal predictors are conservative.*

The smoothed conformal predictor determined by the nonconformity measure (A_n) is a randomized confidence predictor Γ obtained by setting

$$\Gamma^\varepsilon(x_1, \tau_1, y_1, \dots, x_{n-1}, \tau_{n-1} y_{n-1}, x_n, \tau_n) \quad (23)$$

equal to the set of all labels $y \in \mathbf{Y}$ such that

$$\frac{|\{i=1, \dots, n : \alpha_i > \alpha_n\}|}{n} + \frac{\tau_n |\{i=1, \dots, n : \alpha_i = \alpha_n\}|}{n} > \varepsilon, \quad (24)$$

where α_i are defined by (23). The left-hand side of (24) is called the smoothed p-value.

Theorem 2.2 *Any smoothed conformal predictor is exactly valid.*

If we are given a simple predictor (3) whose output does not depend on the order in which the old examples are presented, than the simple predictor D defines a prediction rule $D_{\setminus z_1, \dots, z_n /} : \mathbf{X} \rightarrow \mathbf{Y}$ by the formula

$$D_{\setminus z_1, \dots, z_n /}(x) := D(z_1, \dots, z_n, x). \quad (25)$$

A natural measure of nonconformity of z_i is the deviation of the predicted label

$$\hat{y}_i := D_{\setminus z_1, \dots, z_n /}(x_i) \quad (26)$$

from the true label y_i . We can also use the deleted prediction defined as

$$\hat{y}_{(i)} := D_{\setminus z_1, \dots, z_{i-1}, z_{i+1}, \dots, z_n /}(x_i). \quad (27)$$

More generally, the prediction rule $D_{\setminus z_1, \dots, z_n /}$ may map \mathbf{X} to some prediction space $\hat{\mathbf{Y}}$ not necessarily coinciding with \mathbf{Y} . An invariant simple predictor is a function D that maps each bag $\setminus z_1, \dots, z_n /$ of each size n to a prediction rule $D_{\setminus z_1, \dots, z_n /} : \mathbf{X} \rightarrow \hat{\mathbf{Y}}$ and such that the function

$$(\setminus z_1, \dots, z_n /, x) \mapsto D_{\setminus z_1, \dots, z_n /}(x) \quad (28)$$

of the type $Z^{(n)} \times \mathbf{X} \rightarrow \hat{\mathbf{Y}}$ is measurable for all n . A discrepancy measure is a measurable function $\Delta : \mathbf{Y} \times \hat{\mathbf{Y}} \rightarrow \mathbb{R}$. Given an invariant simple predictor D and discrepancy measure Δ we define functions A_n as follows: for any $((x_1, y_1), \dots, (x_n, y_n)) \in \mathbf{Z}^*$, the values

$$\begin{aligned} \alpha_i &= A_n(\setminus (x_1, y_1), \dots, (x_{i-1}, y_{i-1}), \\ &\quad (x_{i+1}, y_{i+1}), \dots, (x_n, y_n) /, (x_i, y_i)) \end{aligned} \quad (29)$$

are defined by the formula

$$\alpha_i := \Delta(y_i, D_{\setminus z_1, \dots, z_n /}(x_i)) \quad (30)$$

or the formula

$$\alpha_i := \Delta(y_i, D_{\setminus z_1, \dots, z_{i-1}, z_{i+1}, \dots, z_n /}(x_i)). \quad (31)$$

It can be easily checked that in both cases A_n form a nonconformity measure.

3. Reliability estimates

In this chapter we are interested in different approaches to estimate the reliability of individual predictions in regression.

3.1. Sensitivity analysis

To estimate the reliability for a given example x , we compute the initial prediction K of the example x . Then we label x with $K + \varepsilon(l_{max} - l_{min})$, where ε is a sensitivity parameter, and l_{min} and l_{max} denote the lower and the upper label bounds of the learning examples, respectively. We add the new labeled x in the learning set. In the next step, a new sensitivity model is induced on the modified learning set and this model is used to compute a sensitivity prediction K_ε for the same particular example x . After computing different sensitivity predictions using different values of parameter $\varepsilon \in E$, where E is some set of positive real parameters, the predictions are combined into different reliability estimates. Sensitivity analysis - variance is defined as

$$SEvar(x) := \frac{\sum_{\varepsilon \in E} (K_\varepsilon - K_{-\varepsilon})}{|E|} \quad (32)$$

and sensitivity analysis - bias is defined as

$$SEbias(x) := \frac{\sum_{\varepsilon \in E} (K_\varepsilon - K) + (K_{-\varepsilon} - K)}{2|E|}. \quad (33)$$

3.2. Variance of a bagged model

We are given a learning set $L = \{(x_1, y_1), \dots, (x_n, y_n)\}$. We take repeated bootstrap samples $L^{(i)}$, $i = 1, \dots, m$ from the learning set and induce a model on each of these samples. Each of the models yields a prediction K_i , $i = 1, \dots, m$ for an example x . The label of the example x is predicted by averaging the individual predictions

$$K := \frac{\sum_{i=1}^m K_i}{m}. \quad (34)$$

We call this procedure bootstrap aggregating or bagging. The reliability estimate of a bagged model is defined as the prediction variance

$$BAGV(x) := \frac{1}{m} \sum_{i=1}^m (K_i - K)^2. \quad (35)$$

3.3. Local cross-validation reliability estimate

Suppose we are given an unlabeled example x for which we wish to compute the prediction and the local cross-validation (LCV) reliability estimate. We define the set of k nearest neighbors of x : $N = \{(x_1, C_1), \dots, (x_k, C_k)\}$, where k is selected in

advance. For each $(x_i, C_i) \in N$ we generate a model M_i on $N \setminus \{(x_i, C_i)\}$. Then we compute local leave-one-out (LOO) prediction K_i for example x_i using model M_i and we compute LOO error $E_i = |C_i - K_i|$. The LCV reliability estimate is computed as the weighted average of the nearest neighbors' local errors

$$LCV(x) := \frac{\sum_{(x_i, C_i) \in N} \frac{1}{d(x_i, x)} E_i}{\sum_{(x_i, C_i) \in N} \frac{1}{d(x_i, x)}}, \quad (36)$$

where d is some distance on the object space.

3.4. Local modeling of prediction error

Given a set of k nearest neighbors $N = \{(x_1, C_1), \dots, (x_k, C_k)\}$, we define the estimate CNK ($C_{Neighbors} - K$) for an unlabeled example x as the difference between the average label of the nearest neighbors and the example's prediction K (using the model that was generated on all learning examples)

$$CNK(x) := \frac{\sum_{i=1}^k C_i}{k} - K. \quad (37)$$

3.5. Density-based reliability estimate

The density-based estimation of prediction error assumes that error is lower for predictions which are made in denser problem subspaces (a portion of the input space with a more learning examples), and higher for predictions which are made in sparser problem subspaces. But it has the disadvantage that it does not take into account the learning examples' labels. This causes the method to perform poorly with noisy data and in cases when distinct examples are not clearly separable. Given the learning set $L = \{(x_1, y_1), \dots, (x_n, y_n)\}$, the density estimate for unlabeled example x is defined as

$$p(x) := \frac{\sum_{i=1}^n \kappa(d(x, x_i))}{n} \quad (38)$$

where d denotes some distance on the object space and κ is a kernel function (for example the Gaussian). Since we expect the prediction error to be higher in cases when the density is lower, it means that $p(x)$ correlates negatively with the prediction error. To establish the positive correlation we define the reliability estimate as

$$DENS(x) := \max_{i=1, \dots, n} (p(x_i)) - p(x). \quad (39)$$

4. Simulation

We carried out a simulation to compare different methods for estimating the local error of regression models. We used neural networks with radial basis functions (RBF networks) as our regression models with Gaussian

used as the basis function. Therefore, the output of the RBF network $f : \mathbb{R}^n \rightarrow \mathbb{R}$ has the form

$$f(\mathbf{x}) = \sum_{i=1}^N \pi_i \exp \{ -\beta_i \|\mathbf{x} - \mathbf{c}_i\|^2 \} \quad (40)$$

where N is the number of neurons in the hidden layer, \mathbf{c}_i is the center vector for neuron i , β_i determines the width of the i th neuron and π_i are the weights of the linear output neuron. RBF networks are universal approximators on a compact subset of \mathbb{R}^n . This means that a RBF network with enough hidden neurons can approximate any continuous function with arbitrary precision.

We used a benchmark function similar to some empirical functions used in chemistry to carry out our experiment. This function was introduced in [4]. The value of this function ϑ in the point $(x_1, x_2, x_3, x_4, x_5)$ can be expressed as

$$\vartheta(x_1, x_2, x_3, x_4, x_5) = -A(x_1, x_2) - B(x_2, x_3)C(x_3, x_4, x_5) \quad (41)$$

where

$$\begin{aligned} A(x_1, x_2) &= 0.6g(x_1 - 0.35, x_2 - 0.35) \\ &\quad + 0.75g(x_1 - 0.1, x_2 - 0.1) \\ &\quad + g(x_1 - 0.35, x_2 - 0.1) \\ B(x_2, x_3) &= 0.4g(x_2 - 0.1, x_3 - 0.3) \\ C(x_3, x_4, x_5) &= 5 + 25[1 - \{1 + (x_3 - 0.3)^2 \\ &\quad + (x_4 - 0.15)^2 + (x_5 - 0.1)^2\}^{1/2}] \\ g(a, b) &= 100 - \sqrt{(100a)^2 + (100b)^2} \\ &\quad + 50 \frac{\sin \sqrt{(100a)^2 + (100b)^2}}{\sqrt{(100a)^2 + (100b)^2 + (0.01)^2}}. \end{aligned}$$

Moreover, the input vectors must satisfy following conditions

$$\sum_{i=1}^5 x_i = 1 \quad \text{and} \quad x_i \in [0, 1], \text{ for } i = 1, \dots, 5. \quad (42)$$

We compared different reliability estimates of individual predictions: the width of confidence intervals (CONF), the variance of a bagged model (BAGV) and the local modeling of prediction errors using nearest neighbors (CNK estimate).

We repeated the following procedure five times in our simulation.

- Randomly generate 600 points satisfying the conditions (42).

- Compute the function values of function ϑ in these points.
- Split this set of points into a training set of 500 points and a testing set of 100 points.
- Split the training set into the proper training set and the validation set in proportion 2 : 1.
- Fit RBF networks with 1, 2, 3, 4 and 5 hidden neurons twelve times using the Matlab function `lsqcurvefit` on the proper training set.
- Choose the RBF network with the smallest error on the validation set for each number of hidden neurons.
- Compute the predictions based on the RBF networks for the testing points for each number of hidden neurons.
- Compute the reliability estimates in each of 100 testing points for each number of hidden neurons.
- Compute the real error in each of 100 testing points for each number of hidden neurons.

The initial values of parameters π_i were set as mean of the response vector, initial values of β_i were set as the mean of the standard deviation of the components of training data points. The centers \mathbf{c}_i were set randomly.

The confidence intervals were computed using Matlab function `nlpredci` with the option `simopt` on (CONF1) and off (CONF0). The Jacobian can be computed exactly, because the form of the RBF network is known and differentiable. Therefore, we supply the function `nlpredci` with this Jacobian.

The variance of a bagged model was computed for number of different models $m = 10$ and the bootstrap samples were as big as the original sample.

The CNK estimates were computed for number of neighbors $k = 2, 5, 10$.

Finally, we computed in each of the testing point for each method a Kendall's rank correlation coefficient between the real error and the predicted error for the RBF networks with 1, ..., 5 hidden neurons. Then we took the average correlation for each method for all 100 testing points and average overall. Results can be found in Table 1. Moreover, we computed the number of cases in which the method chose the best model. It means that our method estimated the smallest error for the model with the smallest error. These results can be found in Table 2. Table 3 shows the number of cases in which the best model had given number of hidden neurons.

CONF0	CONF1	CNK2	CNK5	CNK10	BAGV
0.360	0.294	0.568	0.572	0.602	0.392
0.188	-0.030	0.570	0.536	0.540	0.330
0.264	0.078	0.552	0.644	0.650	0.290
0.530	0.462	0.474	0.484	0.454	0.310
0.218	0.034	0.508	0.578	0.596	0.372
0.312	0.168	0.534	0.563	0.568	0.339

Table 1: Correlation of the reliability estimates and the real error in each of the five runs and the average correlation.

CONF0	CONF1	CNK2	CNK5	CNK10	BAGV
39	33	56	56	61	34
28	28	53	50	43	21
47	47	54	56	56	22
24	19	37	42	35	20
26	25	51	55	57	29
164	152	251	259	252	126

Table 2: Number of cases in which the best model was correctly chosen (out of 100 and the summary).

#Neurons	1	2	3	4	5
#Best	16	75	207	88	114

Table 3: The number of cases in which the best model has 1, 2, 3, 4 or 5 hidden neurons.

We can see from the previous tables that the best results are achieved by the CNK reliability estimate. It chose the best model approximately in half of all cases. The number of used neighbors is not too important in our study as the CNK estimate worked very similarly for 2, 5 and 10 neighbors. We can also see from Table 2 and 3 that the CNK estimate chose the best model more often than if we take the globally most suitable model with three hidden neurons. The BAGV model did not perform that well. It chose the best model only one in four cases which is only slightly better than random selection. The correlation is also much lower than for CNK. Finally, the confidence interval with option simopt on worked very poorly. If we use the option simopt off it works

a little bit better. But the correlation is still not too high and also the best model is chosen only one in three cases which is slightly better than BAGV but much worse than the CNK estimate. The reason for this behavior of confidence intervals is probably too nonlinear problem which can not be even locally linearly approximated with sufficient precision.

5. Conclusion

We described some approaches to estimating the reliability of individual predictions in regression. We compared confidence intervals, local modeling of prediction error, and variance of a bagged model in a simulation study. The local modeling of prediction error gave very good results and it could be used for choosing the best model. The confidence intervals did not perform too well, probably because the problem was too complex. In our future work we will try to study conformal predictors more deeply and implement some of these methods in the FAKE GAME (Fully Automated Knowledge Extraction using Group of Adaptive Models Evolution) project.

References

- [1] Z. Bosnic and I. Kononenko, "Comparison of Approaches for Estimating Reliability of Individual Regression Predictions", *Data & Knowledge Engineering*, 504-516, 2008.
- [2] A. Gammerman, G. Shafer, and V. Vovk, "Algorithmic Learning in a Random World", *Springer Science+Business Media*, 2005.
- [3] E. Uusipaikka, "Confidence Intervals in Generalized Regression Models", *Chapman & Hall*, 2009.
- [4] S. Valero, E. Argente, et al., "DoE framework for catalyst development based on soft computing techniques", *Computers and Chemical Engineering*, Vol. 33, No. 1, pp. 225-238, 2009.

Incremental Computation of Succinct Abstractions for Hybrid Systems

Post-Graduate Student:

ING. TOMÁŠ DZETKULIČ

Institute of Computer Science of the ASCR, v. v. i.
Pod Vodárenskou věží 2
182 07 Prague 8, CZ

dzetkulic@cs.cas.cz

Supervisor:

ING. STEFAN RATSCHAN, PH.D.

Institute of Computer Science of the ASCR, v. v. i.
Pod Vodárenskou věží 2
182 07 Prague 8, CZ

ratschan@cs.cas.cz

Field of Study:
Verification of Hybrid Systems

This work was supported by Czech Science Foundation grants 201/08/J020 and 201/09/H057, MŠMT project number OC10048 and institutional research plan AV0Z100300504 of the Czech Republic.

The paper will be presented at the 9th International Conference on Formal Modeling and Analysis of Timed Systems and will be published in the conference proceedings, a volume of the Springer lecture notes in computer science series.

Abstract

In our work, we introduce a new approach to computing abstractions for hybrid systems. In applications, hybrid systems are used as a formalism for modeling embedded systems and various other systems where software interacts with physical environment.

Hybrid systems are dynamic systems with both continuous and discrete state. The *state* of a hybrid system is defined by a discrete *mode* and values for all *continuous variables*. The state in each mode changes continuously according to (ordinary) differential equations or differential inclusions and it is allowed to discretely change i.e., *jump* in case a so-called *jump guard condition* is met. We can use the discrete part of hybrid system to model computer program behavior and continuous part to model physical environment where both components interact with each other.

Informally speaking, safety of a hybrid system is a property that, given a set of states where a system can start its evolution, i.e., *initial states* and a set of states that should not be reached, i.e., *unsafe states*, it is not possible for the system to start in an initial state and evolve into an unsafe state.

Given the hybrid system and a property of hybrid systems, *abstraction* is a discrete system, that if the abstract system has the given property, then the original (the concrete) system has the

property as well. If we cannot prove that the current abstraction has the property, we refine the abstraction, that is, we include more information about the concrete system.

We present our recently published result [1] where the abstractions capture the reachability information relevant for a safety property of a hybrid system as succinctly as possible. This is achieved by an incremental refinement of the abstractions, simultaneously trying to avoid increases in their size as much as possible. The approach is independent of a concrete technique for computing reachability information, and can hence be combined with whatever technique suitable for the problem class at hand.

We show the usefulness of the method in the algorithm for safety verification of hybrid systems based on constraint propagation and abstraction refinement [2].

References

- [1] T. Dzetkulič and S. Ratschan, Incremental Computation Of Succinct Abstractions For Hybrid Systems, 9th International Conference on Formal Modeling and Analysis of Timed Systems 2011.
- [2] S. Ratschan and Z. She, Safety Verification of Hybrid Systems by Constraint Propagation Based Abstraction Refinement, ACM TECS 2007.

Competing Risks of CML-Related Death and Death from Other Causes

Post-Graduate Student:

MGR. JANA FŮRSTOVÁ

First Faculty of Medicine
Charles University in Prague
Kateřinská 32
121 08 Prague 2, CZ

jana.furstova@email.cz

Supervisor:

DOC. MGR. ZDENĚK VALENTA, PH.D.

Department of Medical Informatics
Institute of Computer Science of the ASCR, v. v. i.
Pod Vodárenskou věží 2
182 07 Prague 8, CZ

valenta@euromise.cz

Field of Study:
Biomedical Informatics

Abstract

Survival analysis is a collection of statistical methods for inference on time-to-event data. If several causes of failure occur and the occurrence of one event precludes the occurrence of the other events, the situation is known as competing risks. Since the competing risks violate the fundamental assumption of independent censoring, specific methods for inference are needed. The competing risks model and statistical methods for nonparametric analysis are recalled in this paper. The methods are then illustrated on a real data set of 118 Chronic Myeloid Leukemia (CML) patients from the Clinic of Haemato-oncology of the University Hospital in Olomouc. The overall survival probability and risk factors of two types of failure (death due to CML and death from other causes) are assessed. Predicted probabilities of the two types of failure with stratification based on the risk factors (Sokal score, haematological response to treatment) are shown. The effect of the Sokal score classification is found ambiguous. While the score should identify high- and low-risk CML patients, it seems to be predictive only for the failure due to other causes than CML.

1. Introduction

Methods of survival analysis have become widely used in medical research in the past few decades. Standard survival data (also called time-to-event data) arise in studies where time from some origin to an end-point is measured. The end-point is defined by occurrence of a certain event of interest. The time until the specified event occurs can be characterized by several functions. The most widely used are the survival function, representing the probability of an individual surviving up to time t

(i.e. the probability that the event has not occurred before t), and the hazard function, representing the rate of occurrence of the event at a given time. Under the assumption of independent censoring, these functions are estimated by the Kaplan-Meier estimator of the survival function and the Nelson-Aalen estimator of the hazard function (for more information, see e.g. [1] or [2]).

In some cases, several causes of failure are possible but the occurrence of one event precludes the occurrence of the other events (e.g. when failures are different causes of death, only the first one can be observed). This situation is known as competing risks. Often, only one event is chosen for analysis, the competing causes of failure are ignored and treated as right-censored observations, and classical survival methods are used for inference [3]. However, this approach leads to a bias in the Kaplan-Meier estimate [4]. The bias is caused by violating one of the fundamental assumptions underlying the Kaplan-Meier estimator – the assumption of independence of distribution of the time to the event and the censoring distribution. Furthermore, independence between distinct causes of failure cannot be verified on the basis of the observed competing risks data [5]. Specific methods are thus needed for the estimation of survival probabilities. The Cox proportional hazards model may be used for regression analysis, but the interpretation of the results becomes different [4].

This paper presents the competing risks model and statistical methods for nonparametric analysis. The methods are then illustrated on real Chronic Myeloid Leukemia (CML) data from the Clinic of Haemato-oncology of the University Hospital in Olomouc, Czech Republic. All statistical methods are implemented with the R software, using the *survival*, *cmprsk* and *mstate* packages [6].

2. Statistical background

Competing risks are used to model a situation where subjects under investigation are exposed to several causes of failure. If failures represent different causes of death, only the first event to occur is observed. In other settings, second and subsequent failures may be observable, but not of interest. The violation of the assumption of independent censoring, leading to a biased Kaplan-Meier estimator, is an important issue in competing risks models. If the competing event time distributions were independent of the distribution of time to the event of interest, this would imply that at each time the risk of this event is the same for subjects that have not yet failed and are still under follow-up as for subjects that have experienced a competing event by that time [4]. However, a subject that is censored due to failure from a competing risk will certainly not experience the event of interest. Since subjects that will never fail (by the failure of interest) are treated as if they could fail (they are censored), the standard Kaplan-Meier estimator overestimates the probability of failure and underestimates the corresponding survival probability [4], [7].

The competing risks data are represented by the failure time T , the failure cause D and a vector of covariates \mathbf{Z} (T is assumed to be a continuous and positive random variable, D takes values in the finite set $\{1, \dots, m\}$). Former approach to competing risks used multivariate failure time models. In such models each subject was assumed to have a potential failure time for each type of event. The earliest event was actually observed and the others were latent. This approach focused on the joint distribution of the times T_1, \dots, T_m of the m different failure types, described by the joint survival function

$$S(t_1, \dots, t_m) = P(T_1 > t_1, \dots, T_m > t_m).$$

The marginal hazard function

$$h_j(t) = \lim_{\Delta t \rightarrow 0^+} \frac{P(t \leq T_j < t + \Delta t | T_j \geq t)}{\Delta t}$$

is defined by the marginal survival

$$S_j(t) = P(T_j > t) = S(0, \dots, 0, t, 0, \dots, 0).$$

However, without additional assumptions, neither the joint survival function is identifiable from the observed data, nor are the marginal distributions [2], [8], [5]. This “latent failure time” approach has thus little practical use.

A recent concept in competing risks models is *the cause-specific hazard function* and *the cumulative incidence function*. These two functions completely specify the

joint distribution of (T, D) , the failure time and the failure cause [9]. The cause-specific hazard function for the j -th cause is defined by

$$\lambda_j(t) = \lim_{\Delta t \rightarrow 0^+} \frac{P(t \leq T < t + \Delta t, D = j | T \geq t)}{\Delta t},$$

for $j = 1, \dots, m$. It represents the hazard of failing from cause j in the presence of the competing events. The cumulative cause-specific hazard is then defined by

$$\Lambda_j(t) = \int_0^t \lambda_j(u) du.$$

A function $S_j(t) = \exp(-\Lambda_j(t))$ should not be interpreted as a marginal survival function unless the competing event time distributions and the censoring distribution are independent (in case of independent censoring, the marginal distribution models the situation when competing events do not occur) [9]. The total hazard $\lambda(t)$ and the overall survival function $S(t)$ are defined in terms of the cause-specific hazards:

$$\lambda(t) = \lim_{\Delta t \rightarrow 0^+} \frac{P(t \leq T < t + \Delta t | T \geq t)}{\Delta t} = \sum_{j=1}^m \lambda_j(t),$$

$$\begin{aligned} S(t) &= P(T > t) = \exp\left(-\int_0^t \lambda(u) du\right) = \\ &= \exp\left(-\sum_{j=1}^m \int_0^t \lambda_j(u) du\right) = \\ &= \exp\left(-\sum_{j=1}^m \Lambda_j(t)\right). \end{aligned}$$

This overall survival function does have an interpretation: It is the probability of not having failed from any cause at time t [3].

The cumulative incidence function of cause j , $I_j(t)$, is defined by

$$I_j(t) = P(T \leq t, D = j), \quad j = 1, \dots, m,$$

and represents the probability of a subject failing due to cause j in the presence of all the competing risks. It can be expressed in terms of the cause-specific hazard and the overall survival function as

$$I_j(t) = \int_0^t \lambda_j(u) S(u) du, \quad j = 1, \dots, m. \quad (1)$$

This function is sometimes called “crude cumulative incidence function” or “subdistribution function”. It is not a proper distribution function because the cumulative probability to fail from cause j remains less than unity, as $I_j(\infty) = P(D = j)$ [1]. The standard Kaplan-Meier

estimator of the probability of failing due to cause j before or at time t satisfies

$$1 - S_j(t) = \int_0^t \lambda_j(u) S_j(u) du, \quad (2)$$

which is similar to the expression of cumulative intensity function $I_j(t)$. Equations (1) and (2) differ by replacing $S(t)$ by $S_j(t)$. Since

$$S(t) \leq S_j(t),$$

then

$$I_j(t) \leq 1 - S_j(t),$$

with equality at t if there is no competition, i.e. if

$$\sum_{k=1, k \neq j}^m \Lambda_k(t) = 0.$$

This shows the bias of the Kaplan-Meier estimator if it is used to estimate $I_j(t)$ [4].

The cumulative incidence function can be estimated using the Kaplan-Meier methodology restricted to specific failures for each cause: Let $0 < t_1 < t_2 < \dots < t_n$ be the ordered distinct times at which failures of any cause occur. Let d_{jk} denote the number of patients failing from cause j at t_k , and let $d_k = \sum_{j=1}^m d_{jk}$ denote the total number of failures (from any cause) at t_k . Let n_k be the number of patients at risk (i.e. patients still in follow-up who have not failed from any cause) at time t_k . Then the cumulative incidence function of cause j at time t is estimated by

$$\hat{I}_j(t) = \sum_{k: t_k \leq t} \hat{\lambda}_j(t_k) \hat{S}(t_{k-1}),$$

where the discretized version of the cause-specific hazard $\lambda_j(t_k) = P(T = t_k, D = j | T > t_{k-1})$ is estimated by

$$\hat{\lambda}_j(t_k) = \frac{d_{jk}}{n_k}$$

and

$$\hat{S}(t) = \prod_{k: t_k \leq t} \left(1 - \sum_{j=1}^m \hat{\lambda}_j(t_k) \right).$$

More detailed derivation of this estimator of $I_j(t)$ can be found in [1] and [4].

Consider now a regression model for the cause-specific hazard functions. Since the cause-specific hazard functions are identifiable, regression on these functions is possible and a competing risks analogue of the Cox proportional hazards model becomes a logical choice [2]. It

models the cause-specific hazard of cause j for a subject with a covariate vector \mathbf{Z} by

$$\lambda_j(t, \mathbf{Z}) = \lambda_{0j}(t) \exp(\beta_j^T \mathbf{Z}),$$

where $\lambda_{0j}(t)$ is the baseline cause-specific hazard of cause j and β_j is a vector of the regression coefficients related to cause j . Both the baseline hazards and the regression coefficients are permitted to vary arbitrarily over the j failure types. Again, let $t_{j1} < t_{j2} < \dots < t_{jk_j}$ denote the k_j times of type j failures, $j = 1, \dots, m$, and let \mathbf{Z}_{ji} be the covariates for the individual that fails at t_{ji} . Partial likelihood is constructed with conditioning at each failure time: (1) on the previous history of failures and censoring, (2) that at time t_{ji} , a single type j failure occurs [4]. The partial likelihood function then reads [2]:

$$L(\beta_1, \dots, \beta_m) = \prod_{j=1}^m \prod_{i=1}^{k_j} \frac{\exp(\beta_j^T \mathbf{Z}_{ji}(t_{ji}))}{\sum_{\gamma \in R(t_{ji})} \exp(\beta_\gamma^T \mathbf{Z}_\gamma(t_{ji}))},$$

where $R(t_{ji})$ is the risk set at time t_{ji} . Estimation and comparison of the regression coefficients β_j can be constructed by applying asymptotic likelihood techniques individually to the m factors.

3. The CML data analysis

For illustration of the competing-risks techniques, data from the Clinic of Haemato-oncology of the University Hospital in Olomouc are used. The data contain 118 patients suffering from Chronic Myeloid Leukemia (CML). CML is a cancer of the white blood cells. It is a form of leukemia characterized by the increased and unregulated growth of predominantly myeloid cells in the bone marrow and the accumulation of these cells in the blood. The median age [in 1999] is 53 years, but all age groups, including children, are affected [10]. The natural history of CML is progression from a benign chronic phase to a blast crisis within three to five years [11]. Blast crisis is the final phase in the evolution of CML, and behaves like an acute leukemia, with rapid progression and short survival. The blast crisis is often preceded by an accelerated phase, which signals that the disease is progressing and transformation to blast crisis is imminent. Drug treatment can usually stop this progression if started early [10], [11], [12]. In the Czech Republic, there are about 200 newly diagnosed CML patients per year [13].

All 118 patients in the data set were treated in the Olomouc University Hospital in the years 1989–2010. The last admissible date of diagnosis for the analysis was in 2006 in order to have sufficient follow-up time for all the

patients. There is one limitation of the data concerning its consistency: the treatment protocol was changed in 2001 because a new drug – Glivec – had been approved for treatment of the chronic phase of CML. Until 2001, patients were treated by Interferon. For first-line treatment, Interferon was used for all patients in the Olomouc data set (even those diagnosed after 2001) and most of the patients surviving after 2001 were then treated by Glivec. Out of the 118 patients, 67 are males (57%). The age of the patients at the date of diagnosis ranges from 18 to 71, with the mean of 48 years and median of 50 years. At the date of diagnosis, the Sokal score [14] is evaluated for patients with CML. It identifies low- and high-risk patients according to their age, spleen size and blood cell count. The high risk group (Sokal score 3) contains 21% of the Olomouc patients ($n = 25$), the low risk group (Sokal score 1) covers 39% ($n = 46$). All other patients were classified with the Sokal score 2. Complete blood count was recorded at the date of dia-

gnosis and haematological response to the treatment was assessed. Overall, 73 patients (62%) achieved complete haematological response (CHR) to the Interferon treatment. Although other types of failure could be considered as well, the focus of this paper is the overall survival with initial point being the date of diagnosis of CML and terminal point being death. The events of interest (competing risks) are two types of failure: death due to CML (includes accelerating disease, progressive disease and blast crisis), and death from other causes (different types of cancer, graft-versus-host disease after stem cell transplantation, suicide, other). By January 2010, 39 patients (33%) have died, 23 patients died due to CML (20%) and 16 due to other causes (14%). Seventy nine patients (67%) did not experience any of these events and were censored in January 2010. All the competing risks estimations are made in terms of the overall survival, i.e. time from the diagnosis of CML to death is considered.

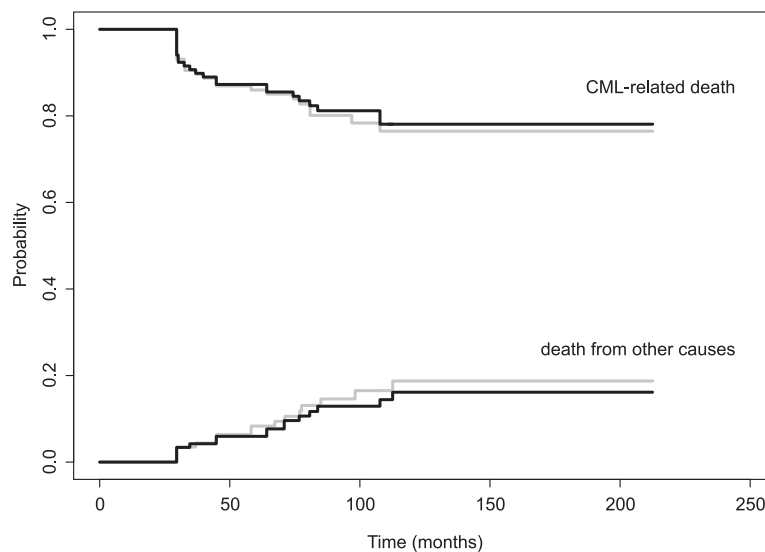

Figure 1: Estimates of probabilities of CML-related death and death from other causes, based on Kaplan-Meier (grey) and on cumulative incidence functions (black).

Figure 1 shows the estimates of the probabilities of “CML-related death” and “death from other causes” for all patients. The CML curves are represented as survival curves, while the other event curves are represented as probability distribution functions (one minus survival) for greater clarity. Estimates based on the Kaplan-Meier method are grey, whereas the estimates of the cumulative incidence functions are black. For this data, the two estimates are relatively close to each other, however, the difference between the curves is obvious. The estimates

of probability of failure based on Kaplan-Meier after 10 years (120 months) of follow-up are $P = 0.24$ for CML-related event resp. $P = 0.19$ for other type of event, while cumulative incidence estimates are $P = 0.22$ and $P = 0.16$ for CML and other type of event, respectively. This illustrates the formerly mentioned claim that the Kaplan-Meier estimator overestimates the probability of failure and underestimates the corresponding survival probability.

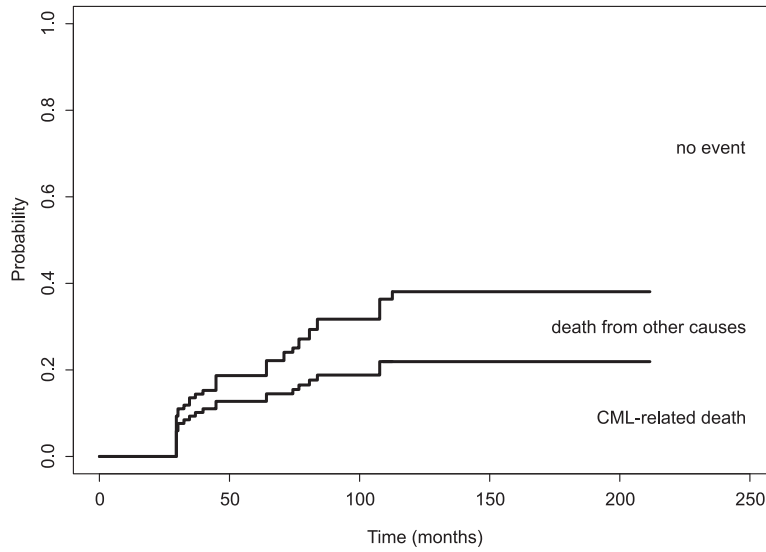

Figure 2: Cumulative incidence curves of CML-related death and death from other causes. Differences between the curves represent probabilities of the particular events.

Figure 2 shows the estimated cumulative incidence curves again, displayed in a different way – they are stacked. The bottom curve represents the estimate of the cumulative incidence function of CML ($\hat{I}_{CML}(t)$), the top curve represents the sum of estimates of the cumulative

incidence functions of CML and other types of death ($\hat{I}_{CML}(t) + \hat{I}_{other}(t)$). This representation allows an easy comparison of the respective probabilities at any time t .

	Mean	Median	Min	Max
Age (years)	48	50	18	71
Leu ($\times 10^9/l$)	131	86	2	777
Hgb (g/l)	125	126	70	161

Table 1: Basic characteristics of the continuous covariate variables: age, leukocyte count and haemoglobin level at the date of diagnosis.

For the regression analysis on cause-specific hazards, several covariates are used. Basic characteristics of the covariates are shown in Tables 1 and 2. Sex, Sokal score and complete haematological response to treatment (CHR) are categorical variables, whereas age at diagnosis, leukocyte count (Leu) and haemoglobin level

(Hgb) at diagnosis are continuous. For purposes of the analyses, in order to make interpretation of results easier, these continuous variables were converted into dichotomous. The cut-off levels were set (by the medical staff) to 45 years of age, $50 \times 10^9/l$ of leukocytes and $110g/l$ of haemoglobin.

		N	%
Sex	male	67	57
	female	51	43
Sokal score	1	46	39
	2	46	39
	3	25	21
CHR	yes	73	62
	no	44	37

Table 2: Basic characteristics of the categorical covariate variables. One value is missing in the Sokal score and the complete haematological response to treatment (CHR) variable.

Table 3 reports the results of the univariate Cox regression analysis with single covariates sex, age, Leu, Hgb, Sokal score and CHR. It is evident that the blood count has strong effect on the rate of occurrence of CML-related death. The leukocyte level above 50 negatively affects overall survival of the CML patients (hazard ratio (HR) = 2.52, $p = 0.09$), while the effect of haemoglo-

bin level above 110 is protective (HR = 0.42, $p = 0.04$). Patients who achieve complete haematological response to treatment, are in a lower risk of death due to CML (HR = 0.33, $p = 0.01$). There is no evidence of any dependence of CML-related death rates on sex, age or the Sokal score. On the other hand, the strongest effect on the rate of occurrence of other

	CML		other	
	$\exp(\hat{\beta}_{CML})$	p -value	$\exp(\hat{\beta}_{other})$	p -value
Sex (male)	1.30	0.55	0.52	0.20
Age (≥ 45)	1.40	0.46	1.43	0.51
Leu (≥ 50)	2.52	0.09	2.31	0.19
Hgb (≥ 110)	0.42	0.04	0.40	0.08
Sokal score	1.43	0.19	2.74	0.004
CHR (yes)	0.33	0.01	0.81	0.70

Table 3: Relative risk estimation for the CML-related death and death from other causes with single covariates.

causes of death is achieved by the Sokal score. The hazard ratio for each extra point in the Sokal score is 2.74 ($p = 0.004$). Thus, an individual having Sokal score 3 has 7.54–times higher risk of death due to other causes compared to the individual having Sokal score 1 (the estimated coefficient $\hat{\beta}_{other} = 1.01$). The effect of haemoglobin level above 110 is the same for other causes of death as for the CML-related death: haemoglobin level above 110 lowers the risk (HR = 0.40, $p = 0.08$). There seems to be no effect of sex, age, leukocyte count and the achievement of complete haematological response to treatment on the risk of death from other causes than CML. However, the results for the sex covariate are inte-

resting. Although the effects are not statistically significant ($p = 0.55$ and $p = 0.20$ for CML and other type of death, respectively), they are opposite for the two types of failure. In case of CML-related death, males may be in higher risk than females (HR = 1.30), while in case of other types of death, the hazard ratio for males relative to females is 0.52. Sex is the only covariate with such opposite effects on the two types of failure. In the multivariate Cox regression model, no combinations of the above mentioned six covariates prove to have statistically significant effects on the risk of failure due to any of the competing risks.

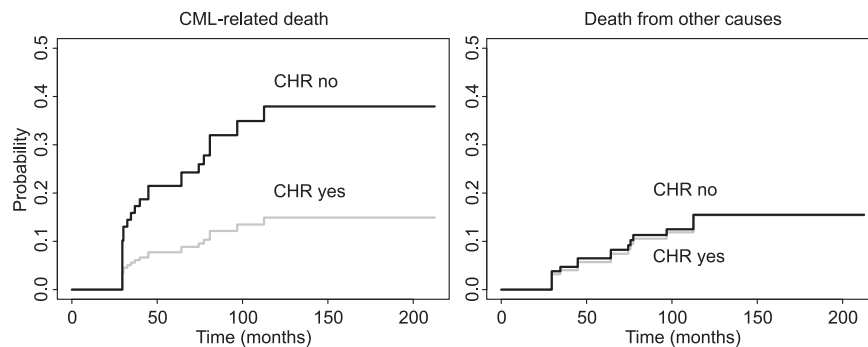

Figure 3: Predicted cumulative incidence functions for CML-related death (left) and death from other causes (right), for patients with and without complete haematological response to treatment, based on the proportional hazards model for the cause-specific hazards.

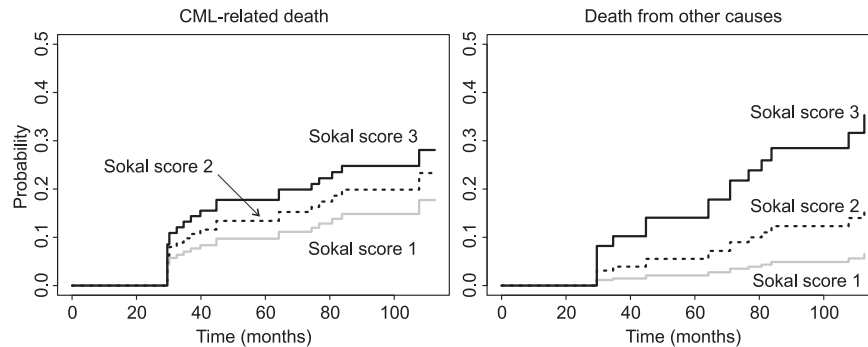

Figure 4: Predicted cumulative incidence functions for CML-related death (left) and death from other causes (right), for the Sokal score classification, based on the proportional hazards model for the cause-specific hazards.

Based on the results of the Cox regression, predicted cumulative incidence curves can be obtained. Figures 3 and 4 show the predicted occurrence of CML-related death and death from other causes for the groups of patients with and without complete haematological response to treatment and for the Sokal score classification. For the CML-related death, the CHR achievement has a strong protective effect: The predicted probabilities of failure due to CML after ten years (120 months) are $P = 0.15$ and $P = 0.38$ for the “CHR yes” and the “CHR no” groups, respectively. On the other hand, there seems to be no relationship between the CHR outcome and failure due to other causes than CML, which is to be expected. For both CHR groups, the predicted probability of death from other causes after ten years from

4. Acknowledgment

The author is grateful to Assoc. Prof. Edgar Faber, M.D. and the Clinic of Haemato-oncology of the University Hospital in Olomouc for providing the data and introducing the author into the subject of CML.

5. Conclusion

The competing risks model and statistical methods for nonparametric analysis are recalled in this paper. The bias in the standard Kaplan-Meier estimator and the need for specific methods for inference on competing risks data is explained. The data set of Chronic Myeloid Leukemia (CML) patients from the Clinic of Haemato-oncology of the University Hospital in Olomouc is analyzed. The overall survival probability and risk factors of two types of failure (death due to CML and death from other causes) are assessed. The interesting role of sex and the Sokal score classification on the overall survival of the CML patients is discussed. Predicted probabilities of the two types of failure with stratification based on the chosen risk factors are shown. The effect of the

the diagnosis is relatively low ($P = 0.15$). The effect of the Sokal score classification is ambiguous. While the score should identify high- and low-risk CML patients, it seems to be predictive only for the failure due to other causes than CML. The predicted probabilities of death from other causes after ten years are $P = 0.35$ and $P = 0.07$ for the Sokal score 3 group and the Sokal score 1 group, respectively. The predicted probabilities of death from CML after ten years are much closer one to another for all the groups – $P = 0.28$ for Sokal score 3 and $P = 0.18$ for Sokal score 1. Other predicted cumulative incidence curves are not presented here, as they can easily be obtained from the results of the Cox regression (see Table 3).

Sokal score classification is found ambiguous. While the score should identify high- and low-risk CML patients, it seems to be predictive only for the failure due to other causes than CML. The use of the Sokal score should be considered more thoroughly.

References

- [1] J.P. Klein and M.L. Moeschberger, *Survival Analysis. Techniques for Censored and Truncated Data*. Springer, New York, 2003.
- [2] J.D. Kalbfleisch and R.L. Prentice, *The Statistical Analysis of Failure Time Data*. John Wiley & Sons, New York, 2002.
- [3] N. Porta, G. Gómez, and M. Luz Calle, *The Role of Survival Functions in Competing Risks*. available at <http://www.eio.upc.es/nporta>, cited on June 20, 2011.
- [4] H. Putter, M. Fiocco, and R.B. Geskus, *Tutorial in Biostatistics: Competing Risks and Multi-State Events*. *Statistics in Medicine* 26, pp. 2389-2430, 2006.

- [5] A. Tsiatis, *A Nonidentifiability Aspect of the Problem of Competing Risks*. Proceedings of the National Academy of Sciences USA 72, pp. 20-22, 1975.
- [6] <http://www.R-project.org>
- [7] T.A. Gooley, W. Leisenring, J. Crowley, and B.E. Storer, *Estimation of Failure Probabilities in the Presence of Competing Risks: New Representations of Old Estimators*. Statistics in Medicine 18, pp. 695-706, 1999.
- [8] D.R. Cox, *The Analysis of Exponentially Distributed Lifetimes with 2 Types of Failure*. Journal of the Royal Statistical Society, Series B 21, pp. 411-421, 1959.
- [9] J. Lawless, *Statistical Models and Methods for Lifetime Data*. John Wiley & Sons, New York, 2003.
- [10] C.L. Sawyers, *Chronic Myeloid Leukemia. Review Article*. The New England Journal of Medicine 340, pp. 1330-1340, 1999.
- [11] S. Faderl, M. Talpaz, Z. Estrov, and H.M. Kantarjian, *Chronic myelogenous leukemia: biology and therapy*. Annals of Internal Medicine 131, pp. 207-219, 1999.
- [12] <http://en.wikipedia.org>, cited on July 13, 2011.
- [13] <http://diagnoza-cml.cz>, cited on June 20, 2011.
- [14] J. Sokal, M. Baccarani, D. Russo, and S. Tura, *Staging and prognosis in chronic myelogenous leukemia*. Seminars in Hematology 25, pp. 49-61, 1988.
- [15] P. Hougaard, *Analysis of Multivariate Survival Data*. Springer, New York, 2000.
- [16] R.L. Prentice, B.J. Williams, and A.V. Peterson, *On the regression analysis of multivariate failure time data*. Biometrika 68, pp. 373-379, 1981.
- [17] H. Putter, *Tutorial in Biostatistics: Competing Risks and Multi-State Models. Analysis Using the mstate Package*. available at <http://cran.r-project.org/web/packages/mstate/vignettes/Tutorial.pdf>, cited on June 1, 2011.
- [18] L. Scrucca, A. Santucci, and F. Aversa, *Competing Risk Analysis Using R: An Easy Guide for Clinicians*. Bone Marrow Transplantation 40, pp. 381-387, 2007.
- [19] T.M. Therneau and P.M. Grambsch, *Modeling Survival Data. Extending the Cox Model*. Springer, New York, 2000.

Traditional Measures of Diversity, Their Estimates and Sensitivity to Changes

Post-Graduate Student:

MGR. MARTIN HORÁČEK

Department of Medical Informatics
Institute of Computer Science of the ASCR, v. v. i.
Pod Vodárenskou věží 2
182 07 Prague 8, CZ

horacek@euromise.cz

Supervisor:

PROF. RNDR. JANA ZVÁROVÁ, DRSC.

Department of Medical Informatics
Institute of Computer Science of the ASCR, v. v. i.
Pod Vodárenskou věží 2
182 07 Prague 8, CZ

zvarova@euromise.cz

Field of Study:
Biomedical Informatics

This work was supported by the project 1M06014 of the Ministry of Education, Youth and Sports of the Czech Republic.

Abstract

The article deals with a family of diversity measure functions known as traditional measures of diversity. We deal with sample estimates of traditional measures of diversity, we develop a new estimator and compare its behavior to two well established estimators in a simulation study. We also introduce a function that can be used to evaluate the sensitivity of a given diversity measure to changes in a population.

The paper will be presented at the 7th Summer School on Computational Biology and will be published in the conference proceedings.

Data Security in Biomedicine

Post-Graduate Student:

ING. ANNA HORŇÁKOVÁ

Department of Medical Informatics
Institute of Computer Science of the ASCR, v. v. i.
Pod Vodárenskou věží 2
182 07 Prague 8, CZ

hornakova@euromise.cz

Supervisor:

ING. MILAN ŠÁREK, CSC.

CESNET, z.s.p.o.
Žitkova 4
160 00 Prague 6, CZ

ms@cesnet.cz

Field of Study:
Biomedical Informatics

This work has been supported by the Ministry of Education of the Czech Republic under the project 1M06014 (The Centre of Biomedical Informatics - CBI).

Abstract

This thesis analyzes current state of use of biometrics in computer security. It provides an overview of the most commonly used anatomical-physiological and behavioral biometric identification methods. The result of the work will be a new set of methods, which allows reliable identification of the user in the most comfortable way. These new principles of data security will be used to enhance the protection of specialized health record. This will contribute to expansion of generally conceived EHR MUDR concept to other application areas.

1. Introduction

Biometrics, biometric identification and verification have been investigated since the early 80's of the last century. At the end of the 20th century first applications began to emerge, especially in forensic practice where biometrics was represented by automated processing of fingerprints and palm prints found at a crime scene. Nowadays, biometric methods are irreplaceable both in the forensic sciences and in commercially available applications.

In this paper we analyze current state of use of biometrics in computer security, especially the possibilities of identification based on biometric data. Biometric characteristics can be divided into anatomical-physiological and behavioral.

2. Anatomical-physiological biometric characteristics

The most frequently used anatomical-physiological biometric characteristics in common practice are fingerprints, palm prints, geometry of hand shape and scanning of bloodstream patterns of the palm or the back of one's hand.

2.1. Fingerprints and palm prints

Fingerprints and palm prints are based on the uniqueness of ridge patterns. Miniaturization of sensors and processors allows the fingerprint-based biometric identification for large commercial use.

In practice, fingerprints are often used for authentication of persons accessing to computers or communication devices, for enhancement of protection of identification or credit cards, for authorization to access buildings and for protection of precious or dangerous devices from unauthorized use.

Interactive fingerprinting, which is now often implemented in a variety of technical equipment, is done by means of sensors. These sensors may be contact or contactless and their functions can be based on different physical principles [2].

2.1.1 Contact fingerprint sensors: Contact sensors include optical, electronic, optoelectronic, capacitive, pressure and temperature sensors. Some of these sensor types will be described in detail below. Main advantages and disadvantages of each method are clearly shown in Table 1.

Sensor	Advantages	Disadvantages
Optical contact sensors	very quick user-friendly	not resistant to dirt not hygienic don't recognize living tissue
Electronic contact sensors	resistant to dirt very quick user-friendly	not hygienic don't recognize living tissue
Capacitive contact sensors	very quick	not resistant to dirt don't recognize living tissue not hygienic
Temperature contact sensors	recognize living tissue very quick	not hygienic
Optical non-contact sensors	resistant to dirt hygienic very quick	don't recognize living tissue
Ultrasonic non-contact sensors	resistant to dirt hygienic very quick	don't recognize living tissue

Table 1: Comparison of contact and non-contact fingerprint sensors.

Optical contact sensors: Optical sensors are based on FTIR technology (Frustrated Total Internal Reflection). This means that a laser beam illuminates the bottom surface of a finger that touches a transparent sensor plate. Reflected light flux is then captured by a CCD (Charge-Coupled Device) element. The amount of reflected light depends on the depth of papillary lines and furrows. Papillary lines reflect more light than furrows.

Other optical sensors use a thick bundle of optical fibers that are perpendicular to the plane of the sensor. Here again, the method of exposure and reflection of light flow is applied. Another type of sensors uses CMOS technology (Complementary Metal-Oxide-Semiconductor).

Electronic contact sensors: Electronic sensors operate on the principle of electric field between two parallel, conductive and electrically charged plates (see Figure 1). If the shape of the originally flat plate on top changes to wavy (papillary lines and furrows), the

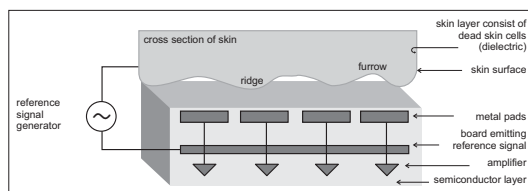

Figure 1: Simplified diagram of the electronic sensors (according to [8]).

shape of the electric field changes too. The upper plate of the sensor is represented by surface of the skin that is connected to the source reference electrical signal.

The main advantage of this sensor is that it does not scan only the surface of the skin but it scans deeper skin layers too. This means that this type of sensor is resistant to dirt and possible damage of the skin surface.

Optoelectronic contact sensors: Optoelectronic sensors consist of two layers. The upper layer is in contact with the skin and it is able to emit light. This light is captured in the second glass layer in which photodiodes are sealed. These photodiodes convert the light into an electrical impulse.

Capacitive contact sensors: Capacitive sensors capture fingerprint by measuring electrical capacity (see Figure 2). Scanning sensor is composed of a large number of scanning surfaces that are isolated from each other. By touching the sensor, papillary lines bridge the conductive pads while furrows act as isolators. The shape of papillary drawing, therefore, modulates voltage and capacitance drops between the conductive pads. These drops are measured and they form a digitalized picture of papillary drawing.

These sensors are highly nonresistant to various types of dirt that may significantly alter conductivity of the skin.

Pressure contact sensors: Pressure sensors respond to a pressure of papillary lines on the surface of sensor.

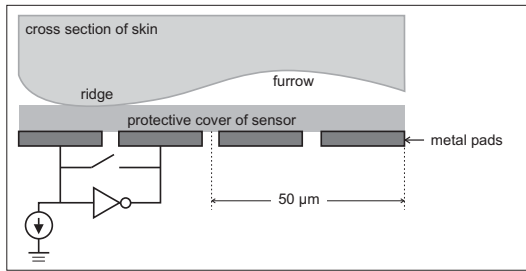

Figure 2: Simplified diagram of the capacitive sensors (according to [8]).

The sensor surface is made of an elastic piezoelectric material that transforms the pressure into an electrical signal and thus creates a picture of fingerprint.

Temperature contact sensors: Temperature sensors react to temperature differences between papillary lines and furrows. A great advantage of this sensor is that temperature is an important factor that can tell whether the scanned fingerprint belongs to a living person.

2.1.2 Contactless sensors for fingerprint:

The best-known groups of non-contact sensors include optical and ultrasound sensors. The main advantages and disadvantages of these sensors are also included in Table 1.

Optical non-contact sensors: The principle of optical non-contact sensors is similar to the optical contact sensors described above with only one difference. The beam of light allows scanning from a distance of 3-5 cm.

The greatest advantage of this sensor is that it prevents contamination caused by contact with dirty fingers.

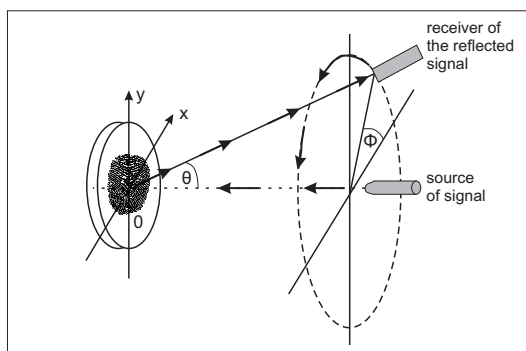

Figure 3: Simplified diagram of the ultrasonic sensors (according to [8]).

Ultrasonic non-contact sensors: Ultrasonic sensors are also based on a similar principle as the optical ones

but instead of a light beam a beam of short mechanical waves (ultrasound) is being reflected from the skin surface (see Figure 3). This type of sensor eliminates all the disadvantages of previous types of sensors explained above [1].

2.2. Geometry of hand shape

Another frequently used method is the geometry of hand shape, the essence of which is measurement of lengths and widths of fingers, bones or joints of the hand (see Figure 4). The hand touches a horizontal scanner that has special fixation pins. These ensure that the hand is always in the same position. The scanner captures one image from the top (perpendicularly to the sensor board) and one image from the side. This generates two monochrome images of 'hand silhouette'.

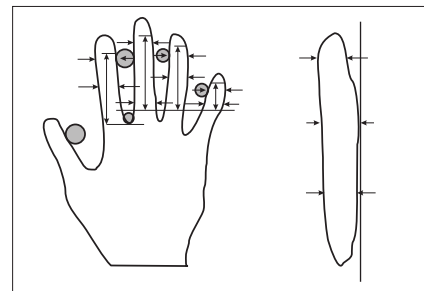

Figure 4: The basic principle of hand geometry (according to [8]).

At first, a user requiring evidence of his identity enters his or her identification number (PIN) via keyboard or he or she touches a magnetic stripe, a chip or a card to a reader. Then the user puts his or her hand to a specified position according to visual instructions that are on keyboard on the scanner [5]. Hand geometry scanners are now common in many areas including healthcare.

2.3. Scanning of the bloodstream of the palm or the back of hand

Another method suitable for use in computer security is scanning of the bloodstream of the palm or the back of one's hand. A CCD camera, which is most commonly used in this case, takes a picture of the hand and a specific pattern of blood vessel distribution captured in the image is then used to identify the person.

An unquestionable advantage of this method is that it also verifies whether the tested object is alive. The scanning runs in infrared band which is sensitive to temperature. This method takes advantage of the fact that blood

vessels in the body are warmer than their surroundings. The scanned image is further processed in a similar way as fingerprint (with the shape of vessels being compared).

Another advantage in comparison to scanning of hand geometry is that it is not necessary to place a hand in the scanner in the same position every time.

Other options for this method are to scan the bloodstream of the palm or to perform non-contact scanning of both the palm and the back of hand, which provides a high level of hygiene unlike hand geometry scanning or fingerprints [5].

2.4. Scanning of face and its parts

Instead of hands a face or a part of the face can be used to identify a person as well. There are computer programs that can recognize human faces like human brain does. Face recognition is now typical especially in criminology and there are many different methods and algorithms used for these purposes.

This method can also be easily used to secure common computing and telecommunication systems. Any standard video camera, which can be already found integrated in many screens, is sufficient to take the image of the face. The face scan can replace traditional password entry. A great advantage of this method is that there is absolutely no need for direct contact between the user and the sensor [10].

However, face recognition can be further improved in many ways. As an example, we can register signs of emotions.

An interesting application of this method in IT security suggests itself. Continuous face scanning during the work with computer would make it possible to evaluate whether it is still the same person accessing sensitive data. Not only that this method secures the system at the time of login, it can even protect the data later on, when the authorized user, for example, leaves the unlocked terminal for a period of time.

2.5. Scanning of iris or retina

Recently, thanks to its simple implementation using only conventional video systems, scanning of iris or retina is becoming a more widespread method of identification. Iris recognition is possible regardless of size, location and orientation but it requires a complicated algorithm. This method is, therefore, usually used only to ensure a high level of security [5].

A light beam is used to map the bloodstream in the retina. A part of the beam is absorbed by the retina while the other part is reflected. Special camera, that is required for the scanning, is expensive and the scanning process itself is not very user-friendly (many people are afraid of the technology) [5].

3. Behavioral biometric characteristics

Keystroke dynamics could be an interesting behavioral biometric characteristic for use in computer security not being widely used so far.

3.1. Keystroke dynamics

Keystroke dynamics allows so-called continuous (dynamic) verification, which is based on the use of keyboard as a medium of continuous interaction between user and computer. This offers a possibility of continuous control over the whole time the computer is being used. This method is useful in situations when there is a risk of leaving a computer without control for a while [3].

The most common characteristic is the time of pressing individual keys or the duration of the keypress. Another possibility is to measure typing speed, frequency of errors, style of writing capital letters or a force used to press the keys. This latter type requires a special keyboard that allows the force of the push to be measured. All other methods can be evaluated by a special program without any modification of hardware [4, 6].

4. Comparison of the methods

Most of current data security systems verify user's authorization to access the system only at the time of login. In the case that the question of user identification is solved only on the basis of biometric data, only one biometric component (or just a few of them) is used for verification in most cases.

A solution should preferentially include the methods mentioned in the introduction and emphasize those of them, which will prove themselves long-time stable or the least disturbing for staff. The method must be fast enough for the user. Hardware requirements and required processing power will also be considered.

Table 1 shows the main advantages and disadvantages of different types of contact and contactless sensors for fingerprinting. All sensors for fingerprinting are relatively quick and easy in comparison to other biometric methods.

Sensor	Advantages	Disadvantages
Geometry of hand shape	resistant to dirt	don't recognize living tissue require scanning in the same position not hygienic
Contactless scanning of bloodstream	don't require scanning in the same position recognize living tissue hygienic resistant to dirt	no possibility of continuous control
Scanning of the face	resistant to dirt recognize living tissue don't require scanning in the same position possibility of continuous control	time-consuming
Scanning of iris	resistant to dirt don't require scanning in the same position user-friendly	
Scanning of retina	resistant to dirt don't require scanning in the same position	not user-friendly time-consuming
Keystroke dynamics	user-friendly possibility of continuous control hardware-efficient	

Table 2: Comparison of anatomical-physiological and behavioral biometric characteristics.

The main differences are in resistance to dirt, which is important for the following two reasons. The first one is that the sensor should be able to work even when there is dirt on its surface or on the surface of the finger that is being scanned. The second reason is, of course, the hygienic aspect.

The greatest benefit is sensor's ability to distinguish living tissue from dead or synthetic material. Then it becomes very resistant to possible abuse.

Table 2 displays main advantages and disadvantages of other anatomical-physiological and behavioral charac-

5. Application of selected methods in electronic health record security

The aim of this work is to propose a multifactor system that will verify a number of biometric features simultaneously, thus ensuring greater reliability of identification. This will protect access to patient data in electronic record personal identification ERPI, which is conceptually based on the proposal of Universal Electronic Health Record MUDR, see [7].

teristics. Besides the aspects mentioned above, we compared also the possibility of continuous authentication, the need for scanning in the same position and difficulty/ease of use.

Table 3 compares selected methods in terms of stability of biometric characteristics and time-consumption. Data in the table are not accurate readings but empirical estimates. The table shows that there is no method that would be "ideal", i.e. would offer high stability of biometric characteristics and low time consumption. Iris scanning, which is currently not used in everyday practice, is close to this ideal.

Security of patient data is one of the key issues in telemedicine. It may appear that this is a standard solution using the principles of electronic record EHR MUDR. But unlike our task, the concept of EHR MUDR record is designed with respect to ordinary patient data, accessed during everyday hospital operation.

Contrastingly, in the case of the electronic record of personal identification ERPI, there will be much more sensitive data related to the identification of individuals from different perspectives. For this reason there is also

Method	Stability of biometric characteristics	Time-consuming
	high = more than 80 %, medium = more than 60 %, low = less than 60 %	high = more than 3 sec, medium = less than 3 sec, low = less than 1 sec
Fingerprint	medium	low
Geometry of hand shape	medium	medium
Scanning of bloodstream	medium	medium
Scanning of the face	low	high
Scanning of iris	high	medium
Scanning of retina	high	high
Keystroke dynamics	low	low

Table 3: Comparison of methods in terms of stability of biometric characteristics in and time-consuming.

a demand for higher level of identification of persons accessing the data.

With regard to the nature of such data it appears necessary to use some set of DLP (Data Loss Prevention) allowing identification of the risks associated with the loss of sensitive data and possible dynamic reduction of these risks. Moreover, with regard to the type of sensitive identification data it is useful to have a resource that will allow consecutive audit of the data.

Commercial solutions such as RSA or Websense are available. These sets are designed to reduce the impact of potential risks, irrespective of whether the data are stored in the datacenter, transmitted over the network

(network DLP) or processed in user terminal equipment (DLP endpoint). This solution is particularly interesting because in Czech Republic there has not yet been a deployment of DLP published in similar context [9].

6. Conclusion

The result should be a complex of new biometric identification methods that would allow reliable identification of users in the most comfortable form. Final application of these new principles of security will increase the level of protection of specialized health record. Furthermore, the EHR MUDR concept will expand to other application areas.

References

- [1] W. Bicz, et al., "Fingerprint structure imaging based on an ultrasound camera", <http://www.optel.com.pl/article/english/article.htm>, 2005.
- [2] N. Cravotta, "Looking under the surface of fingerprint scanners", *EDN*, http://www.edn.com/article/507025-Looking_under_the_surface_of_fingerprint_scanners.php, 2000.
- [3] D. Gunetti and C. Pikardi, "Keystroke analysis of free text." In *ACM Transactions on Information and System Security*, Vol. 8, No. 3, str. 312-347, 2005.
- [4] J. Ilonen, "Keystroke Dynamics." In *Advanced Topics in Information Processing*, Lappeenranta University of Technology, 2003, <http://www2.it.lut.fi/kurssit/03-04/010970000/seminars/Ilonen.pdf>
- [5] A. Jain, R. Bolle, and S. Pankarti, "Biometrics: personal identification in networked society", Kluwer Academic Publisher, Norwell, Massachusetts, USA, 1999.
- [6] F. Monrose and D. Rubin, "Keystroke dynamics as a biometric for authentication". In *Future Generation Computer Systems*, Vol. 16, No. 4, str. 351-359, 2002.
- [7] M. Nagy, et al., "Applied Information Technologies for Development of Continuous Shared Health Care." In *CESNET Conference 08*, CESNET, z.s.p.o., Prague, 2008, <http://www.ces.net/events/2008/conference/cesnet08-proceedings.pdf>
- [8] R. Rak, V. Matyáš, and Z. Říha, "Biometrie a identita člověka: ve forenzních a komerčních aplikacích", Grada, Praha, 2008.
- [9] RSA, The Security Division of EMC: Security Solutions for Business Acceleration [online]. 2010 [cit. 2011-07-19]. RSA Data Loss Prevention (DLP) Suite. <http://www.rsa.com/node.aspx?id=3426>.
- [10] D. Zhang, "Automated biometrics: technologies and systems", Kluwer Academic Publisher, Boston, 2000.

Notes on Condensed Detachment

Post-Graduate Student:

MGR. KAREL CHVALOVSKÝ

Institute of Computer Science of the ASCR, v. v. i.
Pod Vodárenskou věží 2
182 07 Prague 8, CZ

Department of Logic, Charles University
Celetná 20
116 42 Prague 1, CZ

chvalovsky@cs.cas.cz

Supervisor:

MGR. MARTA BÍLKOVÁ, PH.D.

Institute of Computer Science of the ASCR, v. v. i.
Pod Vodárenskou věží 2
182 07 Prague 8, CZ

Department of Logic, Charles University
Celetná 20
116 42 Prague 1, CZ

marta.bilkova@ff.cuni.cz

Field of Study:
Logic

This work was supported by GAČR projects P202/10/1826 and 401/09/H007.

Abstract

We study some basic properties of Hilbert-style propositional calculi with the rule of condensed detachment instead of modus ponens and substitution. The rule of condensed detachment, proposed by Carew A. Meredith, can be seen as a version of modus ponens with the “minimal” amount of substitution.

1. Introduction

Hilbert-style calculi for various propositional logics has been studied by prominent logicians, including Łukasiewicz and Tarski, constituting historically a well-established branch of mathematical logic. These calculi are usually equipped with the rules of detachment, we shall prefer call it modus (ponendo) ponens, and substitution.¹ One of the logicians who significantly contributed to the study of such calculi was Carew A. Meredith. In the 1950’s, he proposed, cf. [1], the rule of condensed detachment as a rule which combines modus ponens with a “minimal” amount of substitution, cf. [2].

The general idea behind the rule of condensed detachment is that from two formulae $\varphi \rightarrow \psi$ and χ , such that there is a most general unifier σ of φ and χ , derive $\sigma(\psi)$. However, this brief version does not contain some important technical details which will be discussed later in the paper, see Definition 2.1.

The use of unification in the definition of condensed detachment suggests its connection with binary resolution, cf. [3]. However, the original formulation did not use unification, which was proposed by Robinson [4] in the 1960’s. There is also a very tight connection with combinatory logic, cf. [2].

¹Since axiom schemata are sometimes used instead of axioms, the rule of substitution is in these cases only implicitly presented.

It is usually claimed that one of the main advantages of condensed detachment over the rules of modus ponens and substitution is an economic presentation of proofs. The reason is that the result of application of condensed detachment is unique (up to variable renaming) and a proof can be presented as a sequence of axioms, there is no need to write substitutions. In this paper we try to discuss some interesting questions which arise if we replace the rules of modus ponens and substitution in Hilbert-style propositional calculi solely by the rule of condensed detachment. Although condensed detachment may seem as a toy tool, there are some rather interesting applications e.g. in proof complexity [5], see Section 3.2.

The paper is organised as follows. In Section 2 we define some basic notions including the rule of condensed detachment. In Section 3 we prove Theorem 3.1 which connects proofs using the rule of condensed detachment and proofs using the rules of modus ponens and substitution. Also the uniqueness of application of condensed detachment concerning the number of different formulae provable from a finite set of axioms by proofs of some maximal given length is discussed in Section 3.1. In Section 4 the notion of **D**-completeness of a set of axioms A , which means that the very same formulae are provable by condensed detachment as by modus ponens and substitution in A , is studied and some basic properties are proved.

We would like to note that the most of the results in this paper, although mainly (re)discovered independently, are implicitly or explicitly discussed in several papers on condensed detachment, cf. [2,3,6]. These papers also influenced the presentation given here.

2. Preliminaries

We fix a countably infinite set of variables $Var = \{p, q, r, \dots\}$. The set of formulae Fml is defined in the standard way: any variable from Var is an element of Fml , if $\varphi, \psi \in Fml$ then also $(\varphi \rightarrow \psi) \in Fml$ and nothing other is a member of Fml . Hence the only connective we are interested in is the implication. The reason for this is that all the things we want to discuss become apparent already in implication fragments. We usually denote formulae by φ, ψ , and χ . The outermost brackets are mostly omitted.

A *substitution* σ is a function $\sigma: Var \rightarrow Fml$. We say that a substitution σ is a *renaming* if $\sigma: Var \rightarrow Var$ is a bijection. The result of an application of a substitution σ on a formula φ , denoted $\sigma(\varphi)$, is the formula obtained by replacing variables in φ according to σ simultaneously. A composition of substitutions $\sigma: Var \rightarrow Fml$ and $\delta: Var \rightarrow Fml$ is a substitution $\sigma \circ \delta = \{\langle p, \psi \rangle \mid (\exists \psi')(\langle p, \psi' \rangle \in \sigma \text{ and } \psi = \delta(\psi'))\}$. The empty substitution is denoted $\epsilon = \{\langle p, p \rangle \mid p \in Var\}$. In this paper substitutions are denoted $\sigma, \delta, \theta, \eta$, and ζ . Instead of using ordered pairs we write a substitution as a set of pairs p/ψ , usually writing only the important one, meaning the substitution is defined as the empty substitution on the other variables.

A formula ψ is a *variant of a formula* φ , abbreviated by $\psi \sim \varphi$, if there is a renaming σ such that $\psi = \sigma(\varphi)$, i.e. $\varphi = \sigma^{-1}(\psi)$. Moreover, we say that a substitution σ is a *variant of a substitution* δ if there is a renaming θ such that $\sigma = \delta \circ \theta$, i.e. $\delta = \sigma \circ \theta^{-1}$.

A *unification* of a set of formulae $F = \{\varphi_1, \dots, \varphi_n\}$ is such a substitution σ that $\sigma(\varphi_1) = \dots = \sigma(\varphi_n)$. If such a substitution exists we say that F is unifiable. Due to the Unification Theorem of Robinson [4], for any unifiable set of formulae F there exists a most general unifier of F . A *most general unifier* (m.g.u.) σ of F is such a unification that for any other unification δ of F , there is a substitution θ such that $\sigma \circ \theta = \delta$. All the most general unifiers, if they exist, are the same up to renaming, they are variants of each other. Since this difference will be unimportant for us we shall write the m.g.u. instead of a m.g.u.

2.1. Hilbert-style calculi

In this paper we study Hilbert-style propositional calculi. A Hilbert-style calculus consists of a set of axioms A , which is just a set of formulae, and deduction rules. The following axioms are discussed in the paper:

$$(B) (p \rightarrow q) \rightarrow ((r \rightarrow p) \rightarrow (r \rightarrow q)),$$

$$(B') (p \rightarrow q) \rightarrow ((q \rightarrow r) \rightarrow (p \rightarrow r)),$$

$$(C) (p \rightarrow (q \rightarrow r)) \rightarrow (q \rightarrow (p \rightarrow r)),$$

$$(I) p \rightarrow p,$$

$$(K) p \rightarrow (q \rightarrow p),$$

$$(W) (p \rightarrow (p \rightarrow q)) \rightarrow (p \rightarrow q),$$

$$(P) ((p \rightarrow q) \rightarrow p) \rightarrow p.$$

The names of axioms are based on corresponding combinators in combinatory logic, with the exception of (P) which stands for Peirce's law. We can present a set of axioms listing the axioms it contains, e.g. BCK denotes the set containing (B), (C), and (K).

We shall use only three deduction rules: modus ponens, substitution, and condensed detachment. The rule of modus ponens (or detachment) derives ψ from $\varphi \rightarrow \psi$ and φ . The rule of substitution derives $\sigma(\varphi)$ from φ for any substitution σ .

Definition 2.1 (Condensed Detachment) *Let us have two formulae $\varphi \rightarrow \psi$ and χ . We produce a variant of χ called χ' , which does not have a common variable with $\varphi \rightarrow \psi$. If there is the m.g.u. σ of φ and χ' , then produce a variant σ' of σ such that no new variable in $\sigma'(\varphi)$ occurs in ψ . The condensed detachment of $\varphi \rightarrow \psi$ and χ , denoted $D(\varphi \rightarrow \psi)\chi$, is $\sigma'(\psi)$. Otherwise, the condensed detachment of $\varphi \rightarrow \psi$ and χ is not defined.*

Note. For technical reasons it is sometimes useful to define condensed detachment not only for formulae containing implication but also for variables. In this case, the condensed detachment of φ , which is a variable, and χ , is defined as φ , cf. [2].

Remark. It is evident that the condensed detachment of φ and ψ is defined uniquely up to variants (renaming). Thus we shall write that $D\varphi\psi \sim \chi$. When the rule of condensed detachment is the only rule we shall also sometimes write $\varphi\psi \sim \chi$.

As Definition 2.1 is quite technical, we discuss the whole process of an application of condensed detachment in details. First, we produce a variant χ' of χ with no common variable with $\varphi \rightarrow \psi$. To see why, consider $\varphi = p \rightarrow p$ and $\chi = p$: there would be no unification of $p \rightarrow p$ and p . Moreover, if we had $\varphi = p \rightarrow p$, $\psi = q \rightarrow q$ and $\chi = q$ the condensed detachment of $\varphi \rightarrow \psi$ and χ would be $(p \rightarrow p) \rightarrow (p \rightarrow p)$.

Another important technical aspect is that the definition requires to produce a variant σ' of σ (note that

σ' is also the m.g.u. of φ and ψ' which satisfies $(\text{Var}(\sigma'(\varphi)) \setminus \text{Var}(\varphi)) \cap \text{Var}(\psi) = \emptyset$. If this condition was not satisfied we would get a result that would not be the most general one.

A *proof* of φ in A is a finite sequence of formulae ψ_1, \dots, ψ_n , where $\psi_n = \varphi$, with the following properties. Every element is a member of A or is derived from the preceding elements of the sequence by a deduction rule. In this paper we study **MP-proofs** which have modus ponens and substitution as their only deduction rules, and **D-proofs** which have condensed detachment as the only deduction rule.

If there is a **D-proof** (**MP-proof**) of φ in A we say that φ is **D-provable** (**MP-provable**) in A . Since we already pointed out that the result of an application of condensed detachment is unique up to variants we mostly do not mention that if φ is **D-provable** in A then also all the variants of φ are **D-provable** in A etc.

It is worth to point out that all the **MP-provable** formulae in BCI, BCK, BCKW, and BCKWP correspond to logics BCI, BCK, the implicational fragment of intuitionistic propositional logic, and the implicational fragment of classical propositional logic, respectively.

Example 2.1 We prove I in CK by condensed detachment. The proof can be described as $(CK)K$, which means that we use condensed detachment on C and K and then on the result and K .

Since $C = (p \rightarrow (q \rightarrow r)) \rightarrow (q \rightarrow (p \rightarrow r))$ and $K = p \rightarrow (q \rightarrow p)$, we produce a variant of K e.g. $s \rightarrow (t \rightarrow s)$. There is the m.g.u. $\sigma = \{r/p, s/p, t/q\}$ of $p \rightarrow (q \rightarrow r)$ and $s \rightarrow (t \rightarrow s)$, which satisfies that no new variable in $\sigma(p \rightarrow (q \rightarrow r))$ occurs in $q \rightarrow (p \rightarrow r)$. It follows that $CK \sim \sigma(q \rightarrow (p \rightarrow r)) = q \rightarrow (p \rightarrow p)$.

Now we can use $q \rightarrow (p \rightarrow p)$ and any provable formula, e.g. K , to prove I . We produce a variant of K e.g. again $s \rightarrow (t \rightarrow s)$. There is the m.g.u. $\tau = \{q/s \rightarrow (t \rightarrow s)\}$ of q and $s \rightarrow (t \rightarrow s)$. Moreover, s and t does not occur in $p \rightarrow p$. It follows that $(CK)K \sim \tau(p \rightarrow p) = p \rightarrow p$.

3. Condensed detachment

It is obvious that condensed detachment can be simply simulated by modus ponens and substitution. As the idea behind the rule of condensed detachment is to be a version of modus ponens equipped with the “minimal”

amount of substitution, we would expect that there is also some connection in the other direction. This connection was probably first explicitly showed in [3] by Kalman.

Theorem 3.1 Let A be a set of axioms and \mathcal{P} be an **MP-proof** in A . Then there is a **D-proof** \mathcal{P}' in A such that every step in \mathcal{P} is a substitution instance of a step in \mathcal{P}' . Moreover, \mathcal{P}' is not longer than \mathcal{P} .

Proof: By induction on the length of the proof \mathcal{P} . If $\mathcal{P} = \psi_1$ then $\psi_1 \in A$ and hence $\mathcal{P}' = \psi_1$. Assume that the claim holds for n and we shall prove it for $n + 1$. It means we have an **MP-proof** $\mathcal{P} = \psi_1, \dots, \psi_n, \psi_{n+1}$ and **D-proof** $\mathcal{P}'' = \psi'_1, \dots, \psi'_m$, where $m \leq n$, corresponding to the **MP-proof** $\mathcal{P}^* = \psi_1, \dots, \psi_n$ as the theorem says. If $\psi_{n+1} \in A$ then $\mathcal{P}' = \psi_1, \dots, \psi'_m, \psi_{n+1}$, or $\mathcal{P}' = \mathcal{P}''$ if ψ_{n+1} already occurs in \mathcal{P}'' , and the claim holds trivially. Otherwise ψ_{n+1} is derived by some deduction rule from \mathcal{P}^* . Both deduction rules are discussed separately.

First, ψ_{n+1} is derived by the rule of substitution from ψ_i , $1 \leq i \leq n$. It means that there is a substitution σ s.t. $\psi_{n+1} = \sigma(\psi_i)$. There is a formula $\psi'_j \in \mathcal{P}''$, $1 \leq j \leq i$, and substitution θ s.t. $\psi_i = \theta(\psi'_j)$. It means that $\psi_{n+1} = \theta \circ \sigma(\psi'_j)$ and $\mathcal{P}' = \mathcal{P}''$.

Second, ψ_{n+1} is derived by the rule of modus ponens from ψ_i and ψ_j , $1 \leq i < j \leq n$. For the sake of generality $\psi_i = \psi_j \rightarrow \psi_{n+1}$. There are formulae $\psi'_k, \psi'_l \in \mathcal{P}''$, $1 \leq k, l \leq j$, formulae φ, ψ , and substitutions θ and η s.t. $\psi_i = \theta(\psi'_k) = \theta(\varphi) \rightarrow \theta(\psi)$ and $\psi_j = \eta(\psi'_l)$. We produce a variant ψ'_l'' of ψ'_l , which does not have a common variable with φ and ψ . Since $\theta(\varphi) = \eta(\psi'_l)$ there is the m.g.u. ζ of φ and ψ'_l'' . We produce a variant ζ' of ζ s.t. $(\text{Var}(\zeta'(\varphi)) \setminus \text{Var}(\varphi)) \cap \text{Var}(\psi) = \emptyset$. Thus $\mathcal{P}' = \psi'_1, \dots, \psi'_m, \zeta'(\psi)$ and there is τ s.t. $\psi_{n+1} = \theta(\psi) = \zeta' \circ \tau(\psi) = \tau(\zeta'(\psi))$. ■

Corollary 3.2 Let φ be a formula and A be a set of axioms. Then φ is **MP-provable** in A iff there is a formula ψ and substitution σ s.t. ψ is **D-provable** in A and $\sigma(\psi) = \varphi$.

Note. It is easy to transform any **MP-proof** \mathcal{P} to another **MP-proof** \mathcal{P}' such that all the substitutions occur before any application of modus ponens. Theorem 3.1 can be from a certain point of view understood as an attempt to produce an **MP-proof** \mathcal{P}'' where modus ponens occurs before substitution as much as possible.

3.1. Proofs with a given length

In Hilbert-style calculi with only finitely many axioms it is hard to enumerate explicitly all the formulae provable in a given number of steps, because there are in general infinitely many substitution instances. Our situation is completely different, there are only finitely many such provable formulae (up to variants) if we use only condensed detachment, namely:

Observation 3.3 *Let $|A| = m$ be a set of axioms and Γ_n^A be the set of all formulae **D**-provable in A by proofs with at most n steps, then $|\Gamma_n^A|$ is $\mathcal{O}(m^{2^{n-1}})$ up to variants.*

This means that for a finite set of axioms A we can iteratively generate all formulae provable in it. Thus if there is an **MP**-proof \mathcal{P} of φ in a finite A with at most n steps then there is by Theorem 3.1 a **D**-proof \mathcal{P}' of ψ in A with at most n steps such that there is a substitution σ such that $\sigma(\psi) = \varphi$. Since there is a finite upper bound on the number of all possible ψ , see Observation 3.3, and we can easily test whether there is such a substitution σ for given ψ and φ , we can produce a proof \mathcal{P}' in finite time. Moreover, we can find all such ψ , there are only finitely many up to variants, and all **D**-proofs \mathcal{P}' of ψ in A not longer than n . Among them, there is also some ψ' and its **D**-proof \mathcal{P}'' in A , from which we can construct an **MP**-proof \mathcal{P}''' of φ in A with at most n steps. This way we can show that there is no **MP**-proof of φ in a finite A with at most a given number of steps.

3.2. An application of condensed detachment in proof complexity

Urquhart in [5] proves a lower bound on the length of the proofs in Hilbert-style calculi for classical propositional logic with the rules of modus ponens and substitution, called *substitution Frege systems* in proof complexity. There are tautologies of length $\mathcal{O}(n)$, for sufficiently large n , which require proofs with $\Omega(\frac{n}{\log n})$ steps. The proof is based on the connection between **MP**-proofs and **D**-proofs via Theorem 3.1.

4. **D**-completeness

Although we know that there is a tight connection for a given set of axioms A between **MP**-provable formulae and substitution instances of **D**-provable formulae, it does not mean that any **MP**-provable formula is also **D**-provable (up to variants) without the use of substitution. On the other hand, it does not either mean that there is a **MP**-provable formula which is not **D**-provable. To elaborate this problem we define a notion of **D**-complete set of axioms.

Definition 4.1 *Let A be a set of axioms and Γ be the set of all formulae **MP**-provable in A . We say that A is **D**-complete if all the formulae in Γ are **D**-provable in A .*

Theorem 3.1 says how the sets which are not **D**-complete look like:

Observation 4.1 *Let A be a set of axioms then A is not **D**-complete iff there is a formula φ and substitution σ s.t. φ is **D**-provable in A , but $\sigma(\varphi)$ is not.*

The essential question is whether such a bit strange notion of **D**-completeness makes sense at all. However, in [2] Hindley and D. Meredith show that BCI and BCK are not **D**-complete, but BCKW and BCKWP are **D**-complete.

Definition 4.2 *Let φ be a formula **MP**-provable in a set of axioms A . We say that a formula φ is basic w.r.t. A if there is no formula ψ **MP**-provable in A and non-renaming substitution σ s.t. $\varphi = \sigma(\psi)$. We say that a set of formulae Γ is basic w.r.t. A if all $\varphi \in \Gamma$ are basic w.r.t. A . Moreover, we say that a set of axioms A is basic if A is basic w.r.t. A .*

Note. For any formula φ **MP**-provable in A , there is a formula ψ basic w.r.t. A and a substitution σ s.t. $\varphi = \sigma(\psi)$. However, such a formula need not be unique: formula $((p \rightarrow p) \rightarrow p) \rightarrow p$ is a substitution instance of $((q \rightarrow r) \rightarrow q) \rightarrow q$ or $((q \rightarrow q) \rightarrow r) \rightarrow r$. Both these formulae are basic w.r.t. any set of axioms complete for classical propositional logic.

Lemma 4.2 *Let A be a set of axioms and φ be a formula basic w.r.t. A . Then φ is **D**-provable in A .*

Proof: From Theorem 3.1 it follows that there is a formula ψ **D**-provable in A and substitution σ such that $\sigma(\psi) = \varphi$. Since φ is basic in A , σ is renaming and consequently $\psi \sim \varphi$. ■

We say that two sets of axioms A_1 and A_2 are **MP**-equivalent if they have the same sets of **MP**-provable formulae.

Theorem 4.3 *Let sets of axioms A_1 and A_2 be **MP**-equivalent. If A_1 is **D**-complete and basic, then A_2 is also **D**-complete.*

Proof: Let φ be a formula **MP**-provable in A_2 . Then φ is **MP**-provable in A_1 , and consequently also **D**-provable in A_1 , by the **D**-completeness of A_1 . Since A_1 is basic w.r.t. A_1 , and thus it is basic w.r.t. A_2 as well, all the formulae in A_1 are **D**-provable in A_2 , by Lemma 4.2. Therefore we can transform any **D**-proof of φ in A_1 into a **D**-proof of φ in A_2 . ■

Note. In [6], three **MP**-equivalent sets of three axioms are presented, **BB'I** among them, but only one of them is **D**-complete. Hence **BB'I** is not **D**-complete by Theorem 4.3, because **BB'I** is basic. Moreover, the two remaining sets differ only in one axiom, and the one from the **D**-complete set is a substitution instance of the other one from the set which is not **D**-complete. Although it may look a bit surprising it holds generally.

Corollary 4.4 *If a set of axioms A is not **D**-complete then there is no set of axioms A' **MP**-equivalent to A , **D**-complete, and basic.*

As we already know about **BCI**, **BCK**, and **BB'I** that these sets are not **D**-complete, we know that there are no **D**-complete and basic sets of axioms **MP**-equivalent to them.

On the other hand, Theorem 4.3 has mainly a positive meaning. We can easily check that **BCKW** and **BCKWP** are basic. It means that any set of axioms which is together with modus ponens and substitution complete for the implicational fragment of intuitionistic logic or classical logic, respectively, is also **D**-complete.

The following lemmata, especially the second one, are very useful to prove that some set of axioms is **D**-complete. They say that not even all the instances of axioms are **D**-provable in sets of axioms which are not **D**-complete.

Lemma 4.5 *Let A be a set of axioms. All the substitution instances of axioms in A are **D**-provable iff A is **D**-complete.*

Proof: Any **MP**-proof \mathcal{P} can be transformed to an **MP**-proof \mathcal{P}' where all the substitutions occur before any application of modus ponens, and modus ponens can be easily simulated by condensed detachment. The converse direction follows from the definition of **D**-completeness. ■

Lemma 4.6 ([6]) *Let A be a set of axioms and $\varphi \rightarrow \varphi$ be **D**-provable in A for any formula φ . Then A is **D**-complete.*

Proof: For any φ **MP**-provable in A , there exists ψ s.t. ψ is **D**-provable in A and φ is a substitution instance of ψ . From the provability of ψ and $\varphi \rightarrow \varphi$ we immediately obtain that φ is provable by condensed detachment. ■

Note. The fact that A contains **I** and all the instances of other axioms are provable does not mean that A is **D**-complete. Let $A = \{((\varphi \rightarrow \varphi) \rightarrow \varphi) \rightarrow \varphi \mid \varphi \text{ is a formula}\} \cup \{p \rightarrow p\}$. Then A is not **D**-complete since only formulae in A are provable.

It is evident that for any set A there exists its superset $A' = \{\varphi \mid \varphi \text{ is **MP**-provable in } A\}$ which is **D**-complete and have the same **MP**-provable formulae as A . However, such a set is infinite even for a finite A , if $A \neq \emptyset$. Moreover, there is a finite set A , namely $A = \mathbf{I}$, which does not have a finite superset **MP**-equivalent to A .

Theorem 4.7 *There is no finite set of axioms A which is **D**-complete and **MP**-equivalent to \mathbf{I} .*

Proof: Assume that such a set $A = \{\varphi_1, \dots, \varphi_n\}$, consisting only of substitution instances of $p \rightarrow p$, exists. Since our setting is very special, we show that any **D**-proof in A can be transformed to an equivalent **D**-proof in A , proves the same formula, with very special properties.

The condensed detachment of $\varphi \rightarrow \varphi$ and ψ is $\sigma(\varphi) = \sigma(\psi')$, for the m.g.u. σ of φ and ψ' , which is a suitable variant of ψ . The key point is that a formula which is the result of unification of φ and ψ' is itself the result of condensed detachment. Let $\psi: \chi_1, \dots, \chi_m$ mean $D(\dots(D(D\psi \chi_1) \chi_2) \dots) \chi_m$. Such a notation represents a formula by presenting its proof. The following three statements hold. All of them can be proved by checking the properties of most general unifiers and how the rule of condensed detachment behaves in our very special setting.

1. $\psi: \chi_1, \dots, \chi_m$ is a variant of $\psi: \chi'_1, \dots, \chi'_k$, where χ'_1, \dots, χ'_k , for $k \leq m$, contains exactly once all the members of χ_1, \dots, χ_m in any order.

2. All the following formulae are variants of each other:

$$\psi_1: \chi_1, \dots, \chi_k, (\psi_2: \chi_{k+1}, \dots, \chi_m), \quad (1)$$

$$\psi_1: (\psi_2: \chi_1, \dots, \chi_m), \quad (2)$$

$$\psi_1: (\psi_2: \chi'_1, \dots, \chi'_l), \quad (3)$$

where χ'_1, \dots, χ'_l , for $l \leq m$, contains exactly once all the members of χ_1, \dots, χ_m in any order.

3. $\psi_1: (\psi_2: \dots (\psi_k: \chi_1, \dots, \chi_m) \dots)$ is a variant of $\psi'_1: (\psi'_2: \dots (\psi'_l: \chi_1, \dots, \chi_m) \dots)$, where ψ'_1, \dots, ψ'_l , for $l \leq k$, contains exactly once all the members of ψ_1, \dots, ψ_k in any order.

Consequently, any **D**-proof in A can be transformed to a **D**-proof $\psi_1: (\psi_2: \dots (\psi_k: \chi_1, \dots, \chi_m) \dots)$, where $k, m \leq n$; if $i < j$, $\psi_i = \varphi_{i'}$, and $\psi_j = \varphi_{j'}$ then $i' < j'$; and if $i < j$, $\chi_i = \varphi_{i'}$, and $\chi_j = \varphi_{j'}$ then $i' < j'$. Therefore there are only finitely many **D**-provable formulae in A up to variants. ■

5. Conclusion

We presented the rule of condensed detachment and studied Hilbert-style propositional calculi in which it is the only deduction rule. We showed a connection between such calculi and more standard calculi with the rules of

modus ponens and substitution. Although generally not all the substitution instances of axioms are provable by condensed detachment, there are sets of axioms in which this is true and we provided some observations on such calculi.

References

- [1] E. J. Lemmon, C. A. Meredith, D. Meredith, A. N. Prior, and I. Thomas, *Calculi of pure strict implication*. Canterbury University College, 1956.
- [2] J. R. Hindley and D. Meredith, "Principal type-schemes and condensed detachment," *The Journal of Symbolic Logic*, vol. 55, no. 1, pp. 90–105, 1990.
- [3] J. A. Kalman, "Condensed detachment as a rule of inference," *Studia Logica*, vol. 42, no. 4, pp. 443–451, 1983.
- [4] J. A. Robinson, "A machine-oriented logic based on the resolution principle," *Journal of the ACM*, vol. 12, pp. 23–41, January 1965.
- [5] A. Urquhart, "The number of lines in Frege proofs with substitution," *Archive for Mathematical Logic*, vol. 37, no. 1, pp. 15–19, 1997.
- [6] N. D. Megill and M. W. Bunder, "Weaker D-complete logics," *Logic Journal of IGPL*, vol. 4, no. 2, pp. 215–225, 1996.

Kalmanův filtr a jeho rozšíření na prostorech velké dimenze

doktorand:

MGR. IVAN KASANICKÝ

Matematicko-fyzikální fakulta
Karlova univerzita
Sokolovská 83
186 75 Praha 8

Ústav informatiky AV ČR, v. v. i.
Pod Vodárenskou věží 2
182 07 Praha 8

kasanick@karlin.mff.cuni.cz

školitel:

DOC. RNDR. DANIEL HLUBINKA,
PH.D.

Matematicko-fyzikální fakulta
Karlova univerzita
Sokolovská 83
186 75 Praha 8

hlubinka@karlin.mff.cuni.cz

obor studia:

Pravděpodobnost a matematická statistika

Abstrakt

Kalmanův filtr, poprvé publikován ještě v šedesátých letech minulého století, je v dnešní době používán ve velkém množství aplikací, jako například při navigaci pomocí systému GPS, případně všude tam, kde není možné měřit bez přítomnosti rušivého šumu. Při jeho použití je však třeba mít uloženou v paměti počítače kovarianční matici, což může být problém, když je tento filtr aplikován na prostorech obrovské dimenze.

Jedním z řešení je ansámbový Kalmanův filtr, který byl navrhnout jako Monte Carlo aproximace původního Kalmanova filtru. Právě na vysvětlení tohoto řešení se zaměříme v tomto článku, přičemž budou v krátkosti a s příslušnými referencemi uvedena i jiná možná řešení.

Navzdory faktu, že ansámbový Kalmanův filtr je hojně používán už od momentu jeho první publikace v roce 1994, až do nedávné doby chyběly studie jeho asymptotických vlastností a očekávané konvergence ke Kalmanově filtru. Protože tyto vlastnosti úzce souvisí s dimenzí prostoru, přivádí nás to na myšlenku přenést oba tyto filtry na prostor nekonečné dimenze. Tato práce bude součástí doktorského studia autora a v závěru tohoto článku jsou uvedeny v současné době řešené problémy s tímto související.

1. Úvod

Kalmanův filtr (KF) byl poprvé prezentován v šedesátých letech minulého století v článcích [8] a [9] jako možné řešení klasické statistické úlohy filtrace signálu a šumu. Dodnes patří k nejpoužívanějším filtrům a s jeho aplikacemi se můžeme setkat i při řešení řady

moderních a populárních problémů, jako je navigace pomocí GPS či příjem FM signálu.

Dalším využitím KF je při tzv. asimilaci dat. Asimilace dat je statistická metoda na odhad skutečného stavu systému (typicky se jedná o dynamický systém vyvíjející se v čase) pomocí řůzných měření s distribucí nerovnoměrně rozloženou v prostoru a čase.

Tento článek je strukturován následujícím způsobem. První část poměrně podrobně popisuje řešený problém, přičemž následuje popis řešení pomocí KF. Další část se zabývá problémy vznikajícími při užití KF na prostorech příliš velké dimenze a řešením těchto problémů se zaměřením na popis ansámbového Kalmanova filtru. Rovněž jsou uvedeny některé další typy filtrů původně odvozených z KF. Poslední část článku klade dosud nevyřešené otázky ohledně přenosu KF na obecný Hilbertův prostor, kterým se bude autor zabývat v průběhu svého doktorského studia.

2. Definice a popis problému

Předpokládáme, že v diskretních časových okamžicích

$$t_1, \dots, t_K$$

máme k dispozici vstupní data (například měření nějakých stavových veličin) ve tvaru m -rozměrných vektorů

$$\mathbf{D}_{t_1}, \dots, \mathbf{D}_{t_K}$$

tj. platí $\mathbf{D}_{t_i} \in \mathbb{R}^m$. Stav zkoumaného systému v jednotlivých časových okamžicích budeme popisovat pomocí vektorů

$$\mathbf{X}_{t_1}, \dots, \mathbf{X}_{t_K}$$

délky n . Uvědomme si, že stav systému v daném okamžiku je náhodný vektor. O jeho distribuci budeme předpokládat dvě základní věci:

- má hustotu na \mathbb{R}^n a
- má omezený druhý moment.

Vstupní data jsou se stavem systému přepojena pomocí observační funkce (operátoru)

$$h_{t_i} : \mathbf{X}_{t_i} \rightarrow h_{t_i}(\mathbf{X}_{t_i}) \sim \mathbf{D}_{t_i},$$

kteřá se může v čase měnit ale je známá. Vývin jednotlivých stavů systému pak popisujeme pomocí funkce

$$\mathcal{M} : (\mathbf{X}_{t_i}, t_i, t_{i+1}) \rightarrow \mathbf{X}_{t_{i+1}},$$

a předpokládáme, že mají Markovskou vlastnost, to jest je splněna rovnost

$$p(\mathbf{X}_{t_K} | \mathbf{X}_{t_1}, \dots, \mathbf{X}_{t_{K-1}}) = p(\mathbf{X}_{t_K} | \mathbf{X}_{t_{K-1}}), \quad (1)$$

kde $p(\cdot)$ značí hustotu. V praxi je většinou funkce \mathcal{M} zadána formou nějakého numerického modelu. Ze statistického hlediska se pak často jedná, v jistém smyslu, o "černou skříňku". Za těchto podmínek je naším cílem odhadnout skutečný stav systému v čase t_K s použitím všech dat dostupných do času t_{K-1} . K tomu využijeme Bayesovu větu, která tvrdí, že za námi deklarovaných podmínek platí

$$p(\mathbf{X}_t^a) = p(\mathbf{X}_t^f | \mathbf{D}_t) \propto p(\mathbf{D}_t | \mathbf{X}_t^f) \cdot p(\mathbf{X}_t^f), \quad (2)$$

\mathbf{X}_t^f se nazývá apriorní stav systému a \mathbf{X}_t^a posteriorní stav systému (v anglických meteorologických zdrojích se tento stav často označuje jako "analysis state").

3. Kalmanův filtr

KF předpokládá, že funkce \mathcal{M} a h_{t_i} jsou lineární, takže je možné napsat je ve tvaru

$$\begin{aligned} \mathcal{M}(\mathbf{X}_{t_i}, t_i, t_{i+1}) &= \mathbf{M}_{t_i} \mathbf{X}_{t_i} + \mathbf{b}_{t_i}, \\ h_{t_i}(\mathbf{X}_{t_i}) &= \mathbf{H}_{t_i} \mathbf{X}_{t_i} + \mathbf{h}_{t_i}^0, \end{aligned} \quad (3)$$

\mathbf{M}_{t_i} a \mathbf{H}_{t_i} jsou matice rozměru $n \times n$ a $m \times n$, \mathbf{b}_{t_i} a $\mathbf{h}_{t_i}^0$ jsou vektory délky n a m . Dále se předpokládá, že apriorní rozdělení stavu systému a podmíněné rozdělení vstupních dat jsou normální s nějakými regulárními kovariančními maticemi $\mathbf{Q}_{t_i}^f$ a \mathbf{R}_{t_i}

$$\begin{aligned} \mathbf{X}_{t_i}^f &\sim N(\boldsymbol{\mu}_{t_i}^f, \mathbf{Q}_{t_i}^f), \\ \mathbf{D}_{t_i} | \mathbf{X}_{t_i}^f &\sim N(\mathbf{H}_{t_i} \mathbf{X}_{t_i}^f, \mathbf{R}_{t_i}). \end{aligned}$$

Z Bayesovy věty (2) plyne, že posteriorní rozdělení stavu zkoumaného systému je taky normální. Pro vyjádření střední hodnoty a varianční matice tohoto rozdělení si definujeme matici

$$\mathbf{K}_{t_i} = \mathbf{Q}_{t_i}^f \mathbf{H}_{t_i}^\top (\mathbf{H}_{t_i} \mathbf{Q}_{t_i}^f \mathbf{H}_{t_i}^\top + \mathbf{R}_{t_i})^{-1} \quad (4)$$

s jejíž pomocí je možné tyto charakteristiky spočítat pomocí jednoduchého vzorce

$$\boldsymbol{\mu}_{t_i}^a = \boldsymbol{\mu}_{t_i}^f + \mathbf{K}_{t_i} (\mathbf{D}_{t_i} - \mathbf{H}_{t_i} \boldsymbol{\mu}_{t_i}^f), \quad (5)$$

$$\mathbf{Q}_{t_i}^a = (\mathbf{I} - \mathbf{K}_{t_i} \mathbf{H}_{t_i}) \mathbf{Q}_{t_i}^f. \quad (6)$$

K odvození těchto rovností je potřeba jenom Bayesovy věty a splnění Markovské vlastnosti, protože spojením (1) a (2) dostáváme, že pro posteriorní rozdělení stavu systému platí

$$p(\mathbf{X}_{t_K}^a) \propto p(\mathbf{D}_{t_K} | \mathbf{X}_{t_K}^f) p(\mathbf{X}_{t_K}^f | \mathbf{D}_{t_1}, \dots, \mathbf{D}_{t_{K-1}}).$$

Pokud tedy chceme v čase t_i předpovědět stav systému v dalším kroku, KF nám poskytuje jednoduchý dvoukrokový algoritmus:

- první krok - určení posteriorního rozdělení

$$\begin{aligned} \boldsymbol{\mu}_{t_i}^a &= \boldsymbol{\mu}_{t_i}^f + \mathbf{K}_{t_i} (\mathbf{D}_{t_i} - \mathbf{H}_{t_i} \boldsymbol{\mu}_{t_i}^f), \\ \mathbf{Q}_{t_i}^a &= (\mathbf{I} - \mathbf{K}_{t_i} \mathbf{H}_{t_i}) \mathbf{Q}_{t_i}^f, \end{aligned}$$

- druhý krok - předpověď

$$\begin{aligned} \boldsymbol{\mu}_{t_{i+1}}^f &= \mathbf{M}_{t_i} \boldsymbol{\mu}_{t_i}^a + \mathbf{b}_{t_i}, \\ \mathbf{Q}_{t_{i+1}}^f &= \mathbf{M}_{t_i}^\top \mathbf{Q}_{t_i}^a \mathbf{M}_{t_i}. \end{aligned}$$

Je třeba si uvědomit, že KF umožňuje, aby se matice \mathbf{M}_{t_i} měnila v čase. Tato vlastnost je potřeba, protože ve většině praktických problémů není funkce \mathcal{M} lineární a členy v rovnosti (3) jsou nahrazeny nějakou lineární aproximací. Jednou z možností je aproximovat matici \mathbf{M}_{t_i} jakobiánem původní funkce \mathcal{M} v bodě t_i a vektor \mathbf{b}_{t_i} hodnotou $\mathcal{M}(0, t_i, t_{i+1})$.

Tím, že je KF znám a používán už mnoho desítek let, je možné najít informace o něm ve spoustě různých knížek či skript. Čtenářům, kteří se více zajímají o tento problém doporučujeme například knihu [12], případně další zdroje uvedené na stránce <http://www.cs.unc.edu/welch/kalman/>, která poskytuje pěkný souhrn současných znalostí o KF, včetně jeho asymptotických vlastností a rychlosti konvergence.

Velkou výhodou KF je, že nám poskytuje přesné algebraické vyjádření pro střední hodnotu (5) a kovarianční matici (6) posteriorního rozdělení stavu systému. K těmto výpočtům je však potřeba nejprve spočítat matici \mathbf{K}_{t_i} pomocí (4). K tomu je však potřeba znalosti matice $\mathbf{Q}_{t_i}^f$, rozměru $n \times n$, kterou sice předpokládáme, nicméně v případě, že je n příliš velké, nemusí být snadné (nebo dokonce možné) takto velkou matici uložit do paměti jakkoliv výkonného počítače. Například při

předpovědi počasí pro Evropu se dnes běžně používá 3D grid s velikostí horizontálního čtverce 10 km a s cca 30-50 vertikálními hladinami. Při použití 6 stavových veličin je n rovné cca 5×10^6 . Při takhle velké dimenzi zatím neexistuje počítač schopný uložit do paměti matice $\mathbf{Q}_{t_i}^f$ a $\mathbf{Q}_{t_i}^o$ a následně s nimi počítat.

4. Ansámblový Kalmanův filtr

Ansámblový Kalmanův filtr (EnKF - z anglického názvu Ensemble Kalman filter) je jedno z možných řešení problému s velkou dimenzí stavového prostoru. Základní myšlenka je prostá, nahradíme kovarianční matice $\mathbf{Q}_{t_i}^f$ a $\mathbf{Q}_{t_i}^o$ výběrovými kovariančními maticemi. Tyto sice mají totožné rozměry, ale jak ukážeme později, není potřeba mít uloženy tyto matice celé v paměti počítače v žádném kroku výpočtu.

Abychom byli schopni spočítat výběrovou kovarianční matici budeme muset, v každém čase t_i , pracovat s náhodným výběrem n -rozměrných vektorů

$$\mathbf{X}_{t_i 1}^f, \dots, \mathbf{X}_{t_i N}^f. \quad (7)$$

Tento výběr se v anglické literatuře o geovědách často označuje slovem "ensemble", jednotlivé členy jsou pak chápány jako všechny možné scénáře vývoje stavu atmosféry.

Ve statistice se za náhodný výběr považuje taková množina náhodných veličin (vektorů), pro kterou platí, že všechny její členy jsou stejně rozděleny a navzájem nezávislé. Jak ukážeme později, členy ansámblu nezávislé nejsou, nicméně v praxi (zejména v geovědách) se často pojmy ansámbl a náhodný výběr zaměňují.

Počet členů ansámblu je N , přičemž platí $N \ll n$. Každý člen obsahuje všechny veličiny popisující stav systému. Takto spočtenou výběrovou kovarianční matici pak dosadíme do vzorců (5) a (6). Tento ansámbl získáme perturbací vstupních dat

$$\mathbf{D}_{t_i} + \mathbf{V}_{t_i 1}, \dots, \mathbf{D}_{t_i} + \mathbf{V}_{t_i N},$$

kde $\mathbf{V}_{t_i j}$ jsou náhodně generované data, navzájem nezávislá, z normálního rozdělení

$$\mathbf{V}_{t_i j} \sim N(\mathbf{0}, \mathbf{R}_{t_i}) \quad \forall i = 1, \dots, N.$$

Připomeňme, že jsme předpokládali následovně podmíněné rozdělení vstupních dat

$$\mathbf{D}_{t_i} | \mathbf{X}_{t_i}^f \sim N(\mathbf{H}_{t_i} \mathbf{X}_{t_i}^f, \mathbf{R}_{t_i}).$$

Pro další výpočet si musíme definovat apriorní odhad střední hodnoty $\bar{\mathbf{X}}_{t_i}^f$ a výběrovou kovarianční matici $\mathbf{C}_{t_i}^f$

standardní cestou

$$\bar{\mathbf{X}}_{t_i}^f = \frac{1}{N} \sum_{j=1}^N \mathbf{X}_{t_i j}^f,$$

$$\mathbf{C}_{t_i}^f = \frac{1}{N} \sum_{j=1}^N (\mathbf{X}_{t_i j}^f - \bar{\mathbf{X}}_{t_i}^f)(\mathbf{X}_{t_i j}^f - \bar{\mathbf{X}}_{t_i}^f)^\top.$$

Podobně jako jsme pro použití KF potřebovali znalost matice \mathbf{K}_{t_i} (4), budeme pro použití EnKF potřebovat definovat matici

$$\mathbf{E}_{t_i} = \mathbf{C}_{t_i}^f \mathbf{H}_{t_i}^\top (\mathbf{H}_{t_i} \mathbf{C}_{t_i}^f \mathbf{H}_{t_i}^\top + \mathbf{R}_{t_i})^{-1}.$$

EnKF pak získáme aplikováním rovností (5) a (6) na každý člen ansámblu, jen matici \mathbf{K}_{t_i} nahradíme maticí \mathbf{E}_{t_i} a kovarianční matici $\mathbf{C}_{t_i}^f$ nahradíme výběrovou kovarianční maticí $\mathbf{Q}_{t_i}^f$. Algoritmus výpočtu EnKF má tedy tvar

- první krok - určení aposterioriho rozdělení

$$\mathbf{X}_{t_i j}^a = \mathbf{X}_{t_i j}^f + \mathbf{E}_{t_i} (\mathbf{D}_{t_i j} - \mathbf{H}_{t_i} \mathbf{X}_{t_i j}^f),$$

- druhý krok - předpověď

$$\mathbf{X}_{(t_i+1)j}^f = \mathbf{M}_{t_i} \mathbf{X}_{t_i j}^a + \mathbf{b}_{t_i}.$$

Uvědomme si, že zatím co v klasickém KF jsou apriorní střední hodnota $\boldsymbol{\mu}_{t_i+1}^f$ a kovarianční matice $\mathbf{Q}_{t_i+1}^f$ určeny deterministicky, jejich analogie v EnKF, $\bar{\mathbf{X}}_{t_i}^f$ a $\mathbf{C}_{t_i}^f$, jsou náhodné veličiny.

Největším přínosem EnKF je skutečnost, že v průběhu celého výpočtu není třeba mít uloženou v paměti kovarianční matici. Nechť \mathbf{u} je libovolný vektor délky n , pak je možné zjednodušit výpočet

$$\mathbf{C}_{t_i}^f \mathbf{u} = \left(\frac{1}{N} \sum_{j=1}^N \mathbf{P}_{t_i j} \mathbf{P}_{t_i j}^\top \right) \mathbf{u}$$

$$= \frac{1}{N} \sum_{j=1}^N (\mathbf{P}_{t_i j}^\top \mathbf{u}) \mathbf{P}_{t_i j},$$

kde jsme označili

$$\mathbf{P}_{t_i j} = \mathbf{X}_{t_i j}^f - \bar{\mathbf{X}}_{t_i}^f.$$

Uvědomme si, že počítání výrazu

$$(\mathbf{X}_{t_i j}^f - \bar{\mathbf{X}}_{t_i}^f)^\top \mathbf{u}$$

je vlastně počítání hodnoty skalárního součinu dvou vektorů délky n . To znamená, že $\mathbf{C}_{t_i}^f \mathbf{u}$ můžeme zjednodušit na součet N skalárních součinů dvou vektorů délky n . Podobně lze zjednodušit

$$\mathbf{H}_{t_i} \mathbf{C}_{t_i}^f \mathbf{H}_{t_i}^\top = \frac{1}{N} \sum_{j=1}^N (\mathbf{H}_{t_i} \mathbf{P}_{t_i j}) (\mathbf{H}_{t_i} \mathbf{P}_{t_i j})^\top,$$

kde pro rozměry výrazů v sumě platí

$$\underbrace{\left(\mathbf{H}_{t_i} (\mathbf{X}_{t_i,j}^f - \bar{\mathbf{X}}_{t_i}^f) \right)}_{m \times 1} \underbrace{\left(\mathbf{H}_{t_i} (\mathbf{X}_{t_i,j}^f - \bar{\mathbf{X}}_{t_i}^f) \right)^\top}_{1 \times m}.$$

Opět jsme tedy výpočet s extrémně velkými maticemi převedli na výpočet skalárního součinu.

EnKF byl poprvé publikován v roce 1994 v článku [4]. Od té doby se stal velmi populární a je používán ve velkém množství případů, kdy je třeba asimilovat data velké dimenze, jako například při předpovědi počasí, předpovědi šíření lesních požárů nebo zpracování obrazu. Podrobné shrnutí této metody spolu s řešením její implementace a dalším rozšířením je možné najít v [5]. Rovněž výborná, ale extrémně obsáhlá je i kniha [7]. Velké množství dalších článků, prezentací a zdrojového kódu vztahujících se k této metodě je možné najít na stránkách <http://enkf.nersc.no/>, které byly a dosud jsou vytvářeny především objevitelem této metody.

Přestože je tato metoda známá a používaná už téměř dvacet let, dlouhou dobu chyběly teoretické studie, zdaleka a za jakých podmínek EnKF konverguje ke KF. Ve většině zdrojů bylo možné najít jen argumentaci založenou na nezávislosti

$$\mathbf{V}_{t_i 1}, \dots, \mathbf{V}_{t_i N},$$

a z toho plynoucí nezávislosti členů ansámblu

$$\mathbf{X}_{t_i 1}, \dots, \mathbf{X}_{t_i N}.$$

Tyto členy jsou však svázány počátečními podmínkami, proto předpoklad jejich nezávislosti není správný. Teprve nedávno se objevily dvě studie zkoumající konvergenci EnKF, a to [11] a [13]. Druhý článek používá upravený slabý zákon velkých čísel, přičemž požadavek na nezávislost členů ansámblu nahrazuje jejich invariancí vůči permutacím, pomocí kterého je dokázána konvergence výběrové kovarianční matice ke skutečné kovarianční matici. Rovněž je v něm dokázána L^p konvergence a rychlost této konvergence. V obou případech je uvažováno fixní n a konvergence je myšlena pro $N \rightarrow \infty$.

5. Další možnosti rozšíření Kalmanova filtru

Z konstrukce výběrové kovarianční matice $\mathbf{C}_{t_i}^f$ vyplývá, že její hodnota je maximálně $N - 1$ a z toho důvodu je perturbace ansámblu

$$\mathbf{X}_{t_i 1}^a - \mathbf{X}_{t_i 1}^f, \dots, \mathbf{X}_{t_i N}^a - \mathbf{X}_{t_i N}^f$$

omezena do prostoru sloupců matice $\mathbf{C}_{t_i}^f$. Když si uvědomíme, že $N \ll n$, jeví se toto jako závažný nedostatek EnKF. Bylo dokonce ukázáno, v článku [1], že

tato skutečnost může, za jistých podmínek způsobit divergenci EnKF. Jedním z řešení je využít metodu lokalizace a podrobně se jí věnují například články [1] a [14].

Další z možných otázek může být, zda-li perturbace dat nepřináší až příliš velké zašumění. Tomuto problému se podrobně věnuje [6], kde je navržena varianta EnKF bez perturbace dat, přičemž algoritmus výpočtu EnKF se pak rozšíří o jeden krok:

- přidaný krok

$$\bar{\mathbf{X}}_{t_i}^a = \bar{\mathbf{X}}_{t_i}^f + \mathbf{E}_{t_i} (\mathbf{D}_{t_i} - \mathbf{H}_{t_i} \bar{\mathbf{X}}_{t_i}^f),$$

- první krok - určení aposterioriho rozdělení

$$\mathbf{X}_{t_i j}^a = \bar{\mathbf{X}}_{t_i j}^a + (\mathbf{X}_{t_i j}^f - \bar{\mathbf{X}}_{t_i}^f) \tilde{\mathbf{E}}_{t_i},$$

- druhý krok - předpověď

$$\mathbf{X}_{(t_i+1)j}^f = \mathbf{M}_{t_i} \mathbf{X}_{t_i j}^a + \mathbf{b}_{t_i},$$

kde matice $\tilde{\mathbf{E}}_{t_i}$ je definovaná jako řešení rovnice

$$\mathbf{C}_{t_i}^a = (\mathbf{I} - \mathbf{E}_{t_i} \mathbf{H}_{t_i}) \mathbf{C}_{t_i}^f.$$

Dalším možným řešením je snažit se o efektivnější generaci zašumění, než je obsažena v klasickém EnKF popsáném v kapitole 4. Obrovskou skupinou patřící do této kategorie jsou takzvané "square-root" filtry. Čtenářům zajímavým se o tyto metody doporučujeme článek [15].

Kromě zde vyjmenovaných existují samozřejmě další druhy filtrů odvozených z EnKF, využívajících se pro asimilaci dat velké dimenze. Rozsáhlé práce pokrývající velké množství dalších filtrů jsou [2] a [10].

6. KF a EnKF na Hilbertově prostoru

Všechny asymptotické výsledky zmiňované v předchozí kapitole platí v případě, že m a n jsou fixovaná, resp. omezená. Přirozenou otázkou zůstává, zdali se tyto vlastnosti zachovávají i když budeme zvyšovat m a n (tj. zvyšovat počet měření a zjemňovat model). Ve statistice se často předpokládá, že chyby měření na dvou různých místech jsou navzájem nezávislé. V případě neustálého zjemňování mřížky se však splnění tohoto předpokladu nedá příliš očekávat. Je proto otázkou, jestli to nemůže pak nepříznivě ovlivnit chování filtru. Tento problém je znám jako tzv. "kletba dimenze".

Z uvedených důvodů by bylo optimální mít dokázanou konvergenci EnKF bez ohledu na dimenzi prostoru.

Jinými slovy by bylo nutné dokázat tuto konvergenci na obecném Hilbertově prostoru (úplný vektorový prostor s definovaným skalárním součinem). Tato úloha však není úplně jednoduchá, například dosud nebylo, dle autorových nejlepších znalostí, nikdy publikováno ani rozšíření klasického KF na obecný Hilbertův prostor, což je samozřejmě nutná podmínka k práci s EnKF na takovémto prostoru.

Jako první krok si uveďme definici náhodné veličiny. Nechť \mathcal{W} je obecný (nekonečně rozměrný) Hilbertův prostor. Skalární součin na něm definován označíme standardně

$$\langle \cdot, \cdot \rangle.$$

Náhodnou veličinu pak na tomto prostoru \mathcal{W} definujeme jako měřitelné zobrazení

$$X_j : (\Omega, \mathcal{S}, P) \rightarrow (\mathcal{W}, \mathcal{B}(\mathcal{W})),$$

kde (Ω, \mathcal{S}, P) je standardně definován pravděpodobnostní prostor a $\mathcal{B}(\mathcal{W})$ je σ -algebra všech Borelovských množin na \mathcal{W} . Střední hodnotu takovéto náhodné veličiny

$$E[X] \in \mathcal{W}$$

definujeme jako řešení rovnice

$$\langle u, E[X]v \rangle = E[\langle u, Xv \rangle] \quad \forall u, v \in \mathcal{W}.$$

Kovarianční operátor $Cov(X, Y)$ se pak definuje jako řešení rovnice

$$\begin{aligned} \langle u, Cov(X, Y)[X]v \rangle &= \\ &= E[\langle u, X - EX \rangle \langle v, Y - EY \rangle] \end{aligned}$$

$\forall u, v \in \mathcal{W}$.

Střední hodnota je jednoznačně definována pro všechny náhodné veličiny

$$X \in L^1(\Omega, \mathcal{W}).$$

Podobně je kovarianční operátor jednoznačně definován pro libovolné dvě náhodné veličiny

$$X, Y \in L^2(\Omega, \mathcal{W}).$$

Tato tvrzení vycházejí z Rieszovy věty o reprezentaci. Podrobně se takovýmto náhodným veličinám věnuje například kniha [3].

V ideálním případě bychom nyní jenom dosadili tyto charakteristiky do rovností (5) a (6) a rozšířili tak KF na prostor \mathcal{W} . Bohužel to není tak jednoduché a tenhle pokus otevírá několik otázek, jako například

- Jak definovat hustotu na nekonečně rozměrném prostoru?

- Platí Bayesova věta na takovémto prostoru?

- Při počítání KF je v kroku (4) nutné invertovat matici $(\mathbf{H}_{t_i} \mathbf{Q}_{t_i}^f \mathbf{H}_{t_i}^\top + \mathbf{R}_{t_i})$. Na prostoru \mathcal{W} by bylo nutné invertovat analogicky definován operátor. Existuje vůbec tento inverzní operátor? Jestli ano, je omezen?

- Jak definovat náhodnou perturbaci na prostoru \mathcal{W}

Odpovědi na tyto a další otázky autorovi zatím nejsou známy a bude na nich pracovat v rámci svého doktorského studia.

Literatura

- [1] J. Anderson, Exploring the need for localization in ensemble data assimilation, using a hierarchical ensemble filter, *Physica D. Nonlinear Phenomena*, 230(1-2), 99-111, 2007.
- [2] J. Beezley, *High-dimensional data assimilation and morphing ensemble Kalman filters with applications in wildfire modeling. Ph.D. Thesis*, Department of Mathematical and Statistical Sciences, University of Colorado Denver, 2009. http://www.math.ucdenver.edu/~jbeezley/jbeezley_thesis.pdf.
- [3] D. Bosq, *Linear Processes in Function Spaces*, Springer, 2000.
- [4] G. Evensen, Sequential data assimilation with a nonlinear quasi-geostrophic model using Monte Carlo methods to forecast error statistics, *Journal of Geophysical Research*, 99, 10143-10162, 1994.
- [5] G. Evensen, The Ensemble Kalman Filter: theoretical formulation and practical implementation, *Ocean Dynamics*, 53, 343-367, 2003.
- [6] G. Evensen, Sampling strategies and square root analysis schemes for the EnKF, *Ocean Dynamics*, 54, 539-560, 2004.
- [7] G. Evensen, *The Ensemble Kalman Filter 2nd ed.*, Springer, 2009.
- [8] R. Kalman, A new approach to linear filtering and prediction problems, *Transaction of the ASME - Journal of Basic Engineering*, 82(1), 35-45, 1960.
- [9] R. Kalman and R. Bucy, New results in filtering and prediction theory, *Transaction of the ASME - Journal of Basic Engineering*, 83, 95-108, 1961.
- [10] E. Kalnay, *Atmospheric modeling, data assimilation, and predictability*, Cambridge University Press, 2003.

- [11] F. Le Gland, V. Monbet, and V.-D. Tran, Large Sample Asymptotics for the Ensemble Kalman Filter, *Technical report, INRIA - Université de Rennes*, 2009. <http://hal.inria.fr/inria-00409060/PDF/RR-7014.pdf>.
- [12] P. Maybeck, *Stochastic models, estimation and control, Volume 2*, Academic Press, 1982.
- [13] J. Mandel, L. Cobb, and J. Beezley, On the convergence of the ensemble Kalman filter, *University of Colorado Denver CCM Report 278*, revised 2011. <http://arxiv.org/abs/0901.2951>.
- [14] E. Ott et al., A local ensemble Kalman filter for atmospheric data assimilation, *Tellus A*, 56, 415-428, 2004.
- [15] M. Tippett et al., Ensemble Square Root Filters, *Monthly Weather Review*, 131, 1485-1490, 2003.

Role Model of Hybrid Intelligence and Computational MAS

Post-Graduate Student:

MGR. ONDŘEJ KAZÍK

Faculty of Mathematics and Physics
Charles University in Prague
Malostranské náměstí 25
118 00 Prague 1, CZ

kazik.ondrej@gmail.com

Supervisor:

MGR. ROMAN NERUDA, CSC.

Institute of Computer Science of the ASCR, v. v. i.
Pod Vodárenskou věží 2
182 07 Prague 8, CZ

roman@cs.cas.cz

Field of Study:
Theoretical Computer Science

This research has been partially supported by the Ministry of Education of the Czech Republic under the COST INTELLI project No. OC10047.

Abstract

In this paper we apply the concepts of agent, role and group to the field of hybrid intelligence. The model is formalized in axioms of description logic. The open-world assumption axioms allow to define necessary relations between concepts and individuals in the system. The axioms interpreted in closed world express integrity constraints. The model is implemented in separate ontology agent which fulfils the functions of matchmaking and correctness verification in computational MAS. Apart from simple computational MAS scenario, we specify the role based model of other hybrid intelligence techniques, such as external and evolutionary learning, and preprocessing.

1. Introduction

An agent is a computer system situated in some environment that is capable of autonomous action in this environment in order to meet its design objectives [1]. Its important features are adaptivity to changes in the environment and collaboration with other agents. Interacting agents join in more complex societies, *multi-agent systems* (MAS). These groups of agents gain several advantages such as the applications in distributed systems, delegation of subproblems on other agents, and flexibility of the software system engineering.

Many present-day applications require dynamic and open societies. The importance of interaction and cooperation aspects of agents, therefore, increases. The effort to reuse MAS patterns brings the need of separation of the interaction logic from the inner algorithmic logic of an agent. There are several approaches providing such separation and modeling a MAS from the organizational perspective, such as the *tuple-spaces*, *group computation*, *activity theory* or *roles* [2].

The definitions of concept *role* vary in different frameworks [2]. Generally speaking, a role is an abstract representation of stereotypical behavior common to different classes of agents. Moreover, it serves as an interface, through which agents perceive their execution environment and affect this environment. Such a representation contains a set of actions, *capabilities*, which an associated agent may utilize to achieve its goals. On the other hand, the role defines constraints, which a requesting agent has to satisfy to obtain the role, as well as *responsibilities* for which the agent playing this role holds accountable. The role also serves as a mean of definition of *protocols*, common interactions between agents. An agent may handle more roles, and a role can be embodied by different classes of agents. Moreover, agents can change their roles dynamically.

The role-based solutions may be independent of a particular situation in a system. This allows designing an overall organization of multi-agent systems, represented by roles and their interactions, separately from the algorithmic issues of agents, and to reuse the solutions from different application contexts. The coordination of agents is based on local conditions, namely the positions of an agent playing the role, thus even a large MAS can be built out of simple organizational structures in a modular way.

The *computational multi-agent systems*, i.e. application of agent technologies in the field of hybrid intelligence, showed to be promising by its configuration flexibility and capability of parallel computation. In order to automatize the composition of computational MAS, its formal model in description logic (DL) was introduced [3]. We are employing the concepts of role and group and transform the role model in axioms of DL [4]. In this paper, the necessity of axiom definition both under open and closed-world assumption is highlighted and the model is extended by integrity constraints. This formal de-

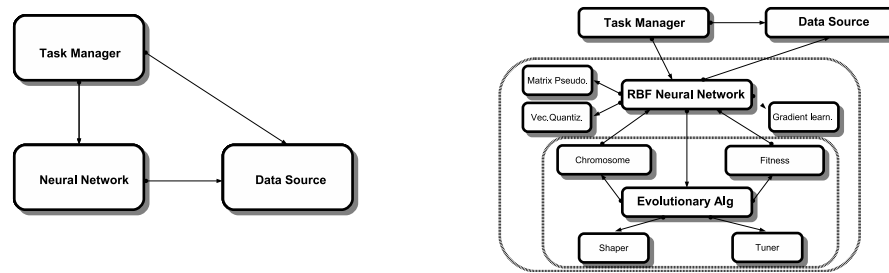

Figure 1: Two examples of computational MAS — the simplest one (left), and the more complicated one (right) containing a neural network trained by an evolutionary algorithm.

scription allows dynamic finding of suitable agents and groups (matchmaking), verification of correctness of MAS (system checking) or automated creation of MAS according to the task.

In the next section, we present a computational intelligence scenario and elaborate the role-based model of a computational MAS. In Section 3, the model is formalized by means of description logic axioms. The data-mining processes often require data pre-processing. The role of a pre-processing agent is defined and included in the model in Section 4. In Section 5, the implementation of ontology agent managing the dynamic role-based of MAS is described. Section 6 concludes the paper and show future work.

2. Role Model of Computational MAS Scenario

Hybrid models including combinations of artificial intelligence methods, such as neural networks, genetic algorithms, and fuzzy logic controllers, can be seen as complex systems with a large number of components and computational methods, and with potentially unpredictable interactions between these parts. These approaches have demonstrated better performance over individual methods in many real-world tasks [5]. The disadvantages are their bigger complexity and the need to manually set them up and tune various parameters. Also, there are not many software packages that provide a large collection of individual computational methods, as well as the possibility to connect them into hybrid schemes in various ways. Multi-agent systems seem to be a suitable solution to manage the complexity and dynamics of hybrid systems. In our approach, a computational MAS contains one or more computational agents, i.e. highly encapsulated objects embodying a particular computational intelligence method and collaborating with other autonomous agents to fulfill its goals. Several models of development of hybrid intelligent systems by means of MAS have been proposed, e.g. [6] and [7].

In order to illustrate the abilities of role-based models we will present an example of analysis of a computational MAS scenario. We are exploiting the conceptual framework of the AGR model [8]. Its organization-centered perspective allowing modular and variable construction of MAS is well suited especially to more complicated configurations of computational agents. On the other hand, GAIA establishes the static assignment between roles and agent-classes. We are leaving this dynamical aspect to the development of algorithms controlling individual instances of agents. These algorithms employ the concepts of groups and roles, and are allowed to change roles and enter groups during the run-time.

For two examples of computational MAS see Figure 1. These descriptions correspond to physical implementation of agents employing the JADE agent platform and Weka data mining library [3]. The system in our scenario consists of a Task Manager agent, Data Source agent, two computational agents (RBF neural network and Evolutionary algorithm agent) and supplementary agents. In the case of RBF network, there are unsupervised (vector quantization) and supervised (gradient, matrix inverse) learning agents. The evolutionary algorithm agent needs Fitness, Chromosome, Shaper and Tuner agents.

Such a computational MAS is represented by a role *organizational structure* shown at Figure 2. It consists of possible groups, their structures, described by means of admissible roles and interactions between them. This organizational structure contains the following group structures:

- *Computational Group Structure*. It contains three roles: a Task Manager, Computational Agent implementing a computational method and Data Source which provides it with training and testing data.
- *Simple Learning Group Structure* consisting of two roles: a Teacher and Learned Computatio-

nal Agent. This structure is instantiated by three groups for each Teacher (Vector Quantization, Gradient and Matrix Inverse).

- *Evolutionary Algorithm Group Structure* contains an Evolutionary Algorithm Agent, Evolved Computational Agent, Chromosome which translates representation of an individual into the model parameters, Tuner with probabilities of the algorithm and Shaper scaling the individual fitness.

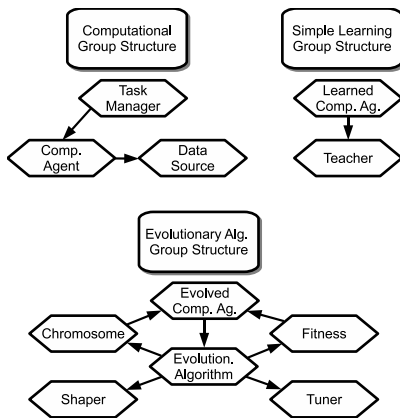

Figure 2: The organizational structure diagram of the computational MAS

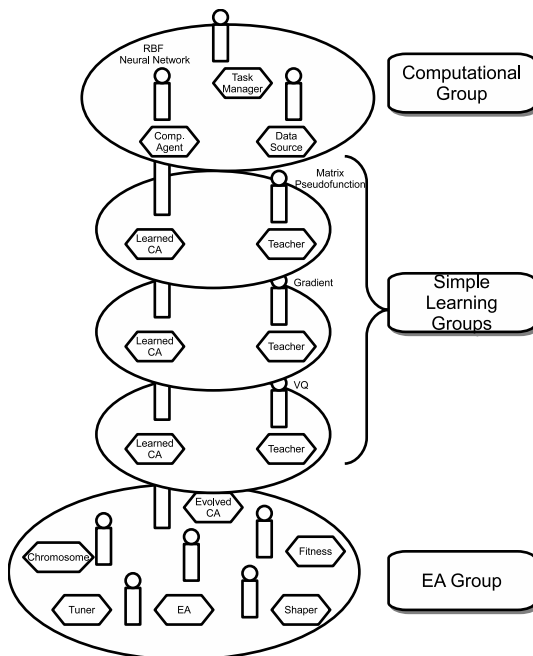

Figure 3: The organization of a concrete computational MAS scenario (cheeseboard notation)

Every concrete organization of the MAS is built with respect to the rules of the organizational structure. Aims of the agents are fulfilled by assuming of roles or establishing of groups and interactions. The agents can play different roles in different groups and even a complicated MAS can be built from these structures.

We will show a typical run of such a computational MAS with data-mining task. At the beginning of the run, only the computational group exists with the RBF network in the role of a computational agent. After the request for learning the problem by the task manager, appropriate simple learning groups are created and the learning agents are constructed, reused or found. Similarly, the evolutionary algorithm group is constructed with all supplementary agents. The interactions proceed according to the definition of organizational structure. Figure 3 shows a state of the concrete organization of such computational MAS.

We can see that the role model allows simplifying the construction of more complicated computational multi-agent systems by its decomposition to the simple group structures and roles, to which the agents assigns. Moreover, the position of an agent in a MAS in every moment of the run-time is defined by its roles without need to take account of its internal architecture or concrete methods it implements. It also reduces a space of possible responding agent when interactions are established.

3. Description Logic Model of Computational MAS

The family of *Description Logic* (DL), fragment of first-order logic, is nowadays de facto standard for ontology description language for formal reasoning [9]. In DL, a knowledge base is divided into a T-Box (terminological box), which contains expressions describing concept hierarchies, and an A-Box (assertional box) containing ground sentences.

Web Ontology Language (OWL), an expressive knowledge representation language, is based on description logic [10]. Semantics of OWL is designed for scenarios where the complete information cannot be assumed, thus it adopts the *Open World Assumption* (OWA). According to the OWA, a statement cannot be inferred to be false only on the basis of a failure to prove it. If there is assumed complete knowledge, the T-Box axioms cannot be used as *Integrity Constraints* (ICs) which would test validity of the knowledge base. In order to check integrity constraints, the *Closed World Assumption* (CWA) is necessary. There are several approaches simulating the CWA by different formalisms, e.g. rules or queries [10].

We continue in the effort to describe the computational MAS in the description logic model [3]. Our model would incorporate the concepts of group and role. In paper [4], we have elaborated basic role-based model of computational MAS in description logic under OWA.

We want to preserve the simplicity of the OWL models and also to express ICs in the same language. In [10] the authors presented an IC validation solution reducing the IC validation problem to SPARQL query [11] answering. Moreover, they introduced a prototype IC validator extending Pellet [12], the OWL reasoner. For example, the constraint that every product has a manufacturer:

$$Product \sqsubseteq \exists isManufacturedBy.Manufacturer$$

would not be violated if there is defined a product without manufacturer in an A-Box [10]. The SPARQL representation of this IC would be the following query:

```
ASK WHERE {
  ?x rdf:type Product.
  OPTIONAL {
    ?x isManufacturedBy ?y.
    ?y rdf:type Manufacturer.
  }
  FILTER(!BOUND(?y))
}
```

Thus we divided the T-Box of the proposed model into two parts. The first part contains axioms describing mainly the concept hierarchy and the necessary relations between their instances. This schema is interpreted in the OWA and defines the facts the reasoner will infer from the given A-Box. In the second part, there are constraints which define the integrity conditions of the system related mainly to the capabilities of agents. These are interpreted on the CWA.¹ The time-dependent information, the current state of the system is in an A-Box of the ontology.

As we have already mentioned, a role is defined as a set of capabilities, i.e. actions (interactions) an agent assuming this role can use, and a set of responsibilities or events the agent should handle. A group is then described by a set of the roles the group contains. A hierarchy of concepts should respect this. The designed T-Box contains the following superior concepts:

- *Responder* is a responsibility of a role. It stands for a message type the agent handles.
- *Initiator* represents an action from a capability set and it is closely related to a particular

Responder. The functional role *isInitiatorOf* relates to the agent which the action uses. The role *sendsTo* contains the agents to which the action is connected.

- *RequestInit* is a subclass of the previous concept which defines only those initiators that send messages to one agent (unlike e.g. the contract net protocol). This concept adds the following IC:

$$RequestInit \sqsubseteq_C \leq sendsTo.1$$

- *Agent* is a superclass of all roles. The role assignment is achieved simply by a concept assertion of the agent individual. The inverse functional roles *hasInitiator* (inverse of *isInitiatorOf*) and *hasResponder* couple an agent with particular actions and responsibilities. While the *hasResponder* relation is a fixed property, the *hasInitiator* occurs only when a corresponding connection is established. Finally, the functional role *isMemberOf* indicates belonging to a group.
- *Group* represents a group in a MAS. It has only one role, an inverse of the *memberOf* role, called *hasAgent*.

The *computational group structure* contains three agents with assigned roles of a task manager, computational agent and data source. Among these roles two connections can be established. First, the task manager sends control messages to the computational agent in order to solve a problem. It contains necessary parameters (data file name, learning options) and an action the computational agent should perform, such as training and testing. The second connection is between the computational agent and data source, which provides data from a specified file.

The sending of control messages between the task manager (*TaskManager*), which initiates this connection, and the computational agent (*CompAgent*) is modeled by two concepts, an initiator (*ControlMsgInit*) and a responder (*ControlMsgResp*). The initiator of this connection is an instance of *ControlMsgInit* which is a subclass of the *RequestInit* class. It sends messages only to an agent with a running responder handling these messages, and it is coupled with a Task Manager role as a capability. The schema file of the ontology contains axioms of the initiator and responder concept hierarchy, and a definition of the responder individual:

$$ControlMsgInit \sqsubseteq_O RequestInit$$

¹Axioms of T-Box are distinguished in the next text by a subscript of the inclusion axiom symbol. A standard schema axiom interpreted in the OWA is in the form $C \sqsubseteq_O E_1$. An integrity constraint in the CWA has the form $C \sqsubseteq_C E_2$.

The following integrity constraints for this concept check the roles of initiating and responding agents:

$$\begin{aligned} &ControlMsgInit \sqsubseteq_C \forall sendsTo. \\ &\quad .\exists hasResponder.ControlMsgResp \\ &\sqcap \forall isInitiatorOf.TaskManager \end{aligned}$$

The control message responder is a simple descendant of the *Responder* concept and this class contains the instance *ControlMsg*. The schema axioms follow:

$$\begin{aligned} &ControlMsgResp \sqsubseteq_O Responder \\ &ControlMsgResp(ControlMsg) \end{aligned}$$

The data connection between the computational agent and the source of data (*DataSource*) is again divided in two classes: initiator *DataMsgInit* and responder *DataMsgResp*. The following axioms for these concepts are similar to those for the control connection:

$$\begin{aligned} &DataMsgInit \sqsubseteq_O RequestInit \\ &DataMsgInit \sqsubseteq_C \forall sendsTo. \\ &\quad .\exists hasResponder.DataMsgResp \\ &\sqcap \forall isInitiatorOf.CompAgent \\ &DataMsgResp \sqsubseteq_O Responder \\ &DataMsgResp(DataMsg) \end{aligned}$$

Role definitions are descendants of the *Agent* concept and have to contain their responsibilities, i.e. responders (capabilities are defined on the initiator side). The responsibility of the computational agent (*CompAgent*) is to respond on the control connections. These are axioms inserted in the schema set:

$$\begin{aligned} &CompAgent \sqsubseteq_O Agent \\ &\sqcap \exists hasResponder.ControlMsg \end{aligned}$$

The data source (*DataSource*) handles requests for data and the task manager (*TaskManager*) role only sends messages in a group:

$$\begin{aligned} &DataSource \sqsubseteq_O Agent \\ &\sqcap \exists hasResponder.DataMsg \\ &TaskManager \sqsubseteq_O Agent \end{aligned}$$

Finally, the computational group (*CompGroup*) contains only the agents which have asserted that they have the computational agent, task manager or data source role. The subclass-axiom is important for open world reasoning:

$$CompGroup \sqsubseteq_O Group$$

On the other hand, entrance of the agent with a wrong role has to be checked by the following closed world constraint:

$$\begin{aligned} &CompGroup \sqsubseteq_C \forall hasAgent. \\ &\quad .(CompAgent \sqcup TaskManager \sqcup DataSource) \end{aligned}$$

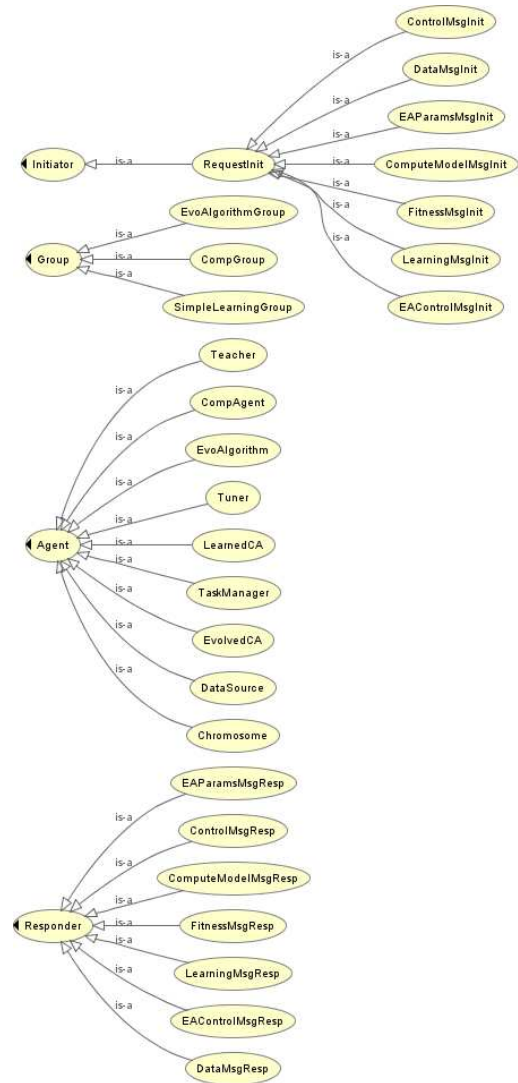

Figure 4: Hierarchy of main ontology concepts in the computational MAS model

The *simple learning group structure* is defined in a similar way by the following schema and integrity rules:

$$\begin{aligned}
& LearningMsgResp \sqsubseteq_O Responder \\
& LearningMsgResp(LearningMsg) \\
& LearningMsgInit \sqsubseteq_O RequestInit \\
& LearningMsgInit \sqsubseteq_C \forall sendsTo. \\
& \quad .\exists hasResponder.LearningMsgResp \\
& \quad \sqcap \forall isInitiatorOf.LearnedCA \\
& LearnedCA \sqsubseteq_O Agent \\
& Teacher \sqsubseteq_O Agent \\
& \quad \sqcap \ni hasResponder.LearningMsg \\
& SimpleLearningGroup \sqsubseteq_O Group \\
& SimpleLearningGroup \sqsubseteq_C \forall hasAgent. \\
& \quad .(Teacher \sqcup LearnedCA)
\end{aligned}$$

Evolutionary algorithm group contains an evolutionary algorithm, evolved computational algorithm, tuner with parameters of the algorithm, and chromosome, i.e. representation of individuals:

$$\begin{aligned}
& EAControlMsgInit \sqsubseteq_O RequestInit \\
& EAControlMsgInit \sqsubseteq_C \forall sendsTo. \\
& \quad .\exists hasResponder.EAControlMsgResp \\
& \quad \sqcap \forall isInitiatorOf.EvolvedCA \\
& EAParamsMsgInit \sqsubseteq_O RequestInit \\
& EAParamsMsgInit \sqsubseteq_C \forall sendsTo. \\
& \quad .\exists hasResponder.EAParamsMsgResp \\
& \quad \sqcap \forall isInitiatorOf.EvoAlgorithm \\
& FitnessMsgInit \sqsubseteq_O RequestInit \\
& FitnessMsgInit \sqsubseteq_C \forall sendsTo. \\
& \quad .\exists hasResponder.FitnessMsgResp \\
& \quad \sqcap \forall isInitiatorOf.EvoAlgorithm \\
& ComputeModelMsgInit \sqsubseteq_O RequestInit \\
& ComputeModelMsgInit \sqsubseteq_C \forall sendsTo. \\
& \quad .\exists hasResponder.ComputeMsgResp \\
& \quad \sqcap \forall isInitiatorOf.Chromosome \\
& EAControlMsgResp \sqsubseteq_O Responder \\
& EAControlMsgResp(EAControlMsg) \\
& EAParamsMsgResp \sqsubseteq_O Responder \\
& EAParamsMsgResp(EAParamsMsg)
\end{aligned}$$

$$\begin{aligned}
& FitnessMsgResp \sqsubseteq_O Responder \\
& FitnessMsgResp(FitnessMsg) \\
& ComputeModelMsgResp \sqsubseteq_O Responder \\
& ComputeModelMsgResp(ComputeModelMsg) \\
& EvolvedCA \sqsubseteq_O Agent \\
& \quad \sqcap \ni hasResponder.ComputeModelMsg \\
& EvoAlgorithm \sqsubseteq_O Agent \\
& \quad \sqcap \ni hasResponder.EAControlMsg \\
& Chromosome \sqsubseteq_O Agent \\
& \quad \sqcap \ni hasResponder.FitnessMsg \\
& Tuner \sqsubseteq_O Agent \\
& \quad \sqcap \ni hasResponder.EAParamsMsg \\
& EvoAlgorithmGroup \sqsubseteq_O Group \\
& EvoAlgorithmGroup \sqsubseteq_C \forall hasAgent. \\
& \quad .(EvolvedCA \sqcup EvoAlgorithm \sqcup \\
& \quad \quad \sqcup Chromosome \sqcup Tuner)
\end{aligned}$$

The main concepts in the ontology described above are shown in Figure 4.

4. Role Model of Preprocessing

The real data sets are often imperfect and noisy, contains outliers, missing values or impossible data combinations or there is redundant and irrelevant information. The computational modeling techniques also impose requirements on the data set. Therefore, separate phase of pre-processing before main computation is necessary [13]. There is variety of pre-processing techniques with different effects on data, e.g. feature extraction, missing values and outlier filtering, or resampling etc.

In order to keep flexibility of computational MAS solution we will implement the pre-processing method as a separate agent. This pre-processing agent obtains data from a data source and provides pre-processed data to other agents. The options of the pre-processing method and source-file have to be set by a task manager who controls the computation.

Therefore the interactions defined in Subsection 3 can be utilized. The pre-processing agent gains properties of both the data source (it provides data) and computational agent (it receives data from another source and waits for control messages). Thus the role of *PreprocessingAgent* is defined as an intersection of *DataSource* and *CompAgent*:

$$PreprocessingAgent \sqsubseteq_O CompAgent \sqcap DataSource$$

The pre-processing agent with this role is also able to enter any computational group according to this definition. It also includes the possibility of creation of agents chain, where on the one end is an agent providing original data table and on the other is a data mining computational method. Diagram of such a configuration with two preprocessing agent is at Figure 5.

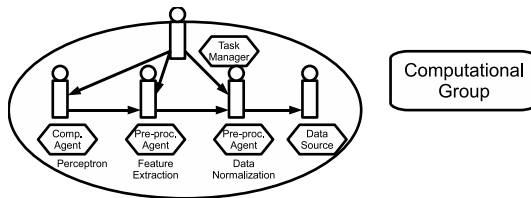

Figure 5: Example of computational MAS configuration with two preprocessing agents.

On a request of the task manager the pre-processing agent obtains data from specified data source and does the pre-processing. On the next request for the data from another computational agent it sends the pre-processed data.

The task manager has to prepare the sequence of computations of the whole data mining process. Its responsibility is to run the pre-processing agents in the right order before it will send a request for the computation of the data mining computational method.

5. Implementation

To coordinate the run-time role organization of MAS a built according to the schemas and constraints of T-Box, it is necessary to have a central authority, separate agent in which the DL model is represented. Other agents will change the state of the model and query it by interaction with this agent.

The model is implemented as an *ontology agent* (OA) in JADE, Java-based framework for a MAS [14]. The goals of the OA are:

- Keeping track of the current state of MAS. Agents present in the MAS register themselves in the OA, state changes of their roles, create and destroy groups and their membership in them, and establish communication channels.
- Verification of correctness of MAS. The OA controls all changes of the system and does not allow activities which would violate the integrity constraints.
- Matchmaking of agents and groups. When explo-

iting the concept hierarchy, it is possible to search groups of certain types or agents that have a certain role, that are members of certain group or that can handle certain types of messages.

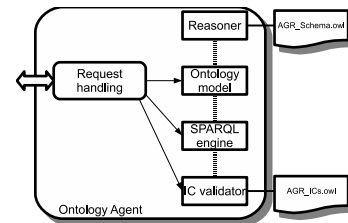

Figure 6: Architecture of the ontology agent.

The ontology agent (shown in Figure 6) consists of the *request handling* module which is responsible for processing of incoming requests and replying. It employs the ontology functions provided by the Pellet OWL-DL reasoner [12] and its extensions. The *ontology model* contains an assertional box of the ontology and describes the current state of the system. The open-world *reasoner* infers new facts from axioms in the OWL schema file and content of the A-Box. The integrity constraints saved in a separate OWL file are converted into SPARQL queries and run by the *SPARQL engine* on the ontology model. The SPARQL engine is also used to answer matchmaking queries.

The *communication ontology* for contents of OA messages has been created. This ontology consists of three types of concepts.

The first group contains *actions* changing the state of the ontology. These actions result in changing of assertions in the A-Box of the model and are validated by the integrity constraints. If any of the ICs is violated, the change is not performed. In this case the action ends by failure. For example, setting of a role of computational agent to the agent *rbf* is achieved by adding the following assertion to the A-Box:

$$\text{CompAgent}(\text{rbf})$$

Removing the role is equivalent to removing this assertion. Similarly the creation of data initiator *init* of agent *rbf* and its connection to an agent *ds* results in:

$$\begin{aligned} &\text{DataMsgInit}(\text{init}) \\ &\text{hasInitiator}(\text{rbf}, \text{init}) \\ &\text{sendsTo}(\text{init}, \text{ds}) \end{aligned}$$

Note that if the *CompAgent* role is not among the roles of agent which owns that initiator, or the receiving

agent does not have a *DataMsgResp* responder, an integrity constraint is violated and the state of the A-Box is undone.

In the second group there are concepts specifying *matchmaking queries* on groups or agents. The description of the requested agent contains its role, group in which it should be or its responders. These queries are transformed into SPARQL queries [10] and executed on the inferred model.

The third group of concepts contains concepts informing about *results* of actions or queries.

6. Conclusion

With rising complexity and dynamism of heterogeneous multi-agent systems, the importance shifts from inner structure and algorithmic logic of individual agents to the cooperation and interaction aspects of the system. The concept of role and role-based models simplifies the development of such multi-agent systems.

Hybrid intelligence system, cooperation of various methods of artificial intelligence, has been successfully implemented as a computational multi-agent system. It contains one or more computational agents, i.e. autonomous encapsulations of individual computational methods, and enables flexibility in run and development of such a MAS.

In this article, we have elaborated the role-based model of computational MAS realizing hybrid intelligence. The model is formalized of description logic. Both the deduction axioms and integrity constraints are defined in the same formalism of OWL-DL with distinction of open-world and closed-world assumptions.

In order to support the real-world data-mining processes, the models of computational group, external and evolutionary learning group, and pre-processing agent have been included. The proposed model of pre-processing allows defining chains of pre-processing agents gradually solving the input data inconsistencies.

The ontology agent representing the model of current MAS state has been implemented. The ontology agent allows general management, correctness verification and matchmaking of the MAS with concepts of agents, roles and groups. For this purpose, reasoning and querying of the DL model is employed.

Further research will be put in ontology classification of computational methods, their parameters and input data. This model will broaden the possibilities of the model

to express the computational MAS dynamics. The role-based model is currently being included in the computational multi-agent system Pikater [15], where arises the problem of choice of best computational method with respect to the unknown input data characteristics, i.e. meta learning.

References

- [1] G. Weiss, ed., *Multiagent Systems*. MIT Press, 1999.
- [2] G. Cabri, L. Ferrari, and L. Leonardi, "Agent role-based collaboration and coordination: a survey about existing approaches," in *Proc. of the Man and Cybernetics Conf.*, 2004.
- [3] R. Neruda and G. Beuster, "Toward dynamic generation of computational agents by means of logical descriptions," *International Transactions on Systems Science and Applications*, pp. 139-144, 2008.
- [4] R. Neruda and O. Kazík, "Role-based design of computational intelligence multi-agent system," in *Proceedings of the International Conference on Management of Emergent Digital EcoSystems, MEDES '10*, pp. 95-101, 2010.
- [5] P. Bonissone, "Soft computing: the convergence of emerging reasoning technologies," *Soft Computing - A Fusion of Foundations, Methodologies and Applications*, pp. 6-18, 1997.
- [6] Z. Zhang and C. Zhang, *Agent-Based Hybrid Intelligent Systems*. Springer Verlag, 2004.
- [7] R. Neruda and G. Beuster, "Emerging hybrid computational models," in *Proc. of the ICIC 2006*, No. LNCS 4113, pp. 379-389, 2006.
- [8] J. Ferber, O. Gutknecht, and M. Fabien, "From agents to organizations: An organizational view of multi-agent systems," in *AOSE 2003* (P. Giorgini *et al.*, eds.), no. LNCS 3950, pp. 214-230, 2004.
- [9] F. Baader *et al.*, *The description logic handbook: Theory, implementation, and applications*. Cambridge University Press, 2003.
- [10] E. Sirin and J. Tao, "Towards integrity constraints in OWL," in *OWLED*, 2009.
- [11] E. Prud'hommeaux and A. Seaborne, "SPARQL query language for RDF," tech. rep., W3C, 2006. <http://www.cs.umn.edu/Ajanta/papers/secure-mgmt.pdf>.
- [12] E. Sirin, B. Parsia, B. C. Grau, A. Kalyanpur, and Y. Katz, "Pellet: A practical OWL-DL reasoner," *Web Semantics: Science, Services and Agents on the World Wide Web*, Vol. 5, No. 2, pp. 51-53, 2007.

- [13] K. Gibert, J. Izquierdo, G. Holmes, I. Athanasiadis, J. Comas, and M. Sanchez-Marre, "On the role of pre and post-processing in environmental data mining," in *International Congress on Environmental Modelling and Software – 4th Biennial Meeting*, pp. 1937-1958, 2008.
- [14] F. Bellifemine, G. Caire, and D. Greenwood, *Developing multi-agent systems with JADE*. John Wiley and Sons, 2007.
- [15] O. Kazík, K. Pešková, M. Pilát, and R. Neruda, "Meta learning in multi-agent systems for data mining," in *WI/IAT 11*, 2011 (in print).

Obstacles in Modeling of Complex Layered Systems in Alloy

Post-Graduate Student:

MGR. JAROSLAV KEZNIKL

Faculty of Mathematics and Physics
Charles University in Prague
Malostranské náměstí 25
118 00 Prague 1, CZ

keznikl@d3s.mff.cuni.cz

Supervisor:

RNDR. TOMÁŠ BUREŠ, PH.D.

Institute of Computer Science of the ASCR, v. v. i.
Pod Vodárenskou věží 2
182 07 Prague 8, CZ

bures@cs.cas.cz

Field of Study:
Software Systems

The work was partially supported by the grant SVV-2011-263312 and by the Grant Agency of the Czech Republic project P202/11/0312.

Abstract

Formal modeling methods are becoming an important part of today's software development process. The Alloy modeling language, which is one of the emerging modeling approaches, is gaining popularity due to its powerful and attractive syntax based on first-order logic and relational calculus. One of the key features of the Alloy solver - Alloy Analyzer - is the ability to find a random instance of a given Alloy model. One outcome of this feature is simplification of the Alloy model development process as the found instances may likely reveal the flaws of the model and thus may serve for debugging. Compared to traditional inspection of an error trace in context of model checking techniques, this brings a serious development speedup. However, this technique turns out to be ineffective for large-scale models of complex systems, as the found instances are getting too complex and the search for the instances is too time-demanding. In this paper, we describe the particular difficulties which may be encountered during modeling of complex systems, give a real-life case study, and propose an overall approach to address these difficulties.

1. Introduction

While modeling large-scale complex systems with multiple concerns, it is often difficult to develop, analyze, and debug such formal models since they are too big to be verified/checked on a regular basis during the development. Moreover, the results given by model verifier (error traces, etc.) are generally hard to interpret which further impedes the model development and analysis. To facilitate the model analysis, the Alloy framework [3,4] offers possibility of finding and inspecting a random instance of the model in development. The reason is that

inspecting such instance may likely reveal some of the flaws of the model. In the rest of the paper, we will refer to such model analysis method based on finding and inspecting model instances as to *example-driven model analysis*. As an aside, in context of Alloy the search for model instances is limited by their maximal size (in terms of number of employed objects). Alloy justifies its approach by proposing the small scope hypothesis [4] according to which counterexamples invalidating a model tend to occur in small models instances already, which in turn are easier to comprehend. Compared to other methods form model analysis such as inspection of error traces, this example-driven model analysis is far more comprehensive. Since this method provides fast feedback during model development, it is suitable for rapid prototyping of formal models.

However, as a model is getting larger, it is more difficult to identify the flaws by analyzing its instances. This is basically caused by three restraining factors:

- (a) The instance generation is random (depending to the implementation of the underlying SAT solver, which often employs random steps to solve the given formula) and the model developer has to first recognize the structure of the new model instance before he can actually analyze the instance. This is more difficult as the instance is getting bigger. Moreover, a model developer typically needs to analyze variations of a certain part of the model, which he is currently working on, only. However, when the developer updates the specification, the newly generated instance can be completely different to the one generated from the original specification.
- (b) As the Alloy Analyzer tool supports incremental execution of the underlying SAT solver, it

allows traversing a sequence of generated instances. However, the 'interesting' instances may be scattered in this sequence (the sequence is likely going to be different for different executions of the tool). Therefore, a tedious traversal of the sequence is required each time a certain scenario is needed for analysis (for example after a change in the model in order to verify that the change corrected a flaw in the scenario). The sequences of the generated instances may contain large amount of 'uninteresting' instances (due to variability in the 'uninteresting' parts of the specification). This together with the fact (a) makes the traversal very difficult.

- (c) The performance demands grow exponentially with the size of the specification (because the specification is transformed into a SAT formula). In scope of the rapid development of Alloy models this represents a serious drawback.

All these limitations restrain the usage of example-driven analysis in context of large and complex models in Alloy.

The Alloy Analyzer provides basically two ways of fighting the restraining factors. The former is the already-mentioned configurable visualization of instances. However, this visualization has severe limitations, such as restricted layout modifications, constrained visualization of individual instance elements, etc. The latter is to provide the model finding process with suitable Alloy specification which constrains the set of model instances to the currently 'interesting' ones. However, in non-trivial models the adequate constraint specification is too extensive and too complex to be written manually.

Nevertheless, the method of systematically constraining the model appears to be a promising approach for fighting the mentioned drawbacks of example-driven analysis. In this sense, a challenge is to find an automatic or semi-automatic way of assessing the constraints and converting them to a corresponding Alloy specification.

1.1. Goals and Structure of the Paper

In this paper, we propose a modeling method for Alloy (i.e., *multilevel modeling*) which enables example-driven model analysis also for large-scale and complex models. The approach is based on partitioning of a model into separate partitions by exploiting the inherent internal structure of the model, and separate constrained analysis of the individual partitions by semi-automatically making the rest of the model immutable. The goal is to allow easy and comprehensive analysis of

a particular model part in development. The key idea is that the immutable model partitions restrict the set of all model instances, so that the found instances are easier to comprehend (as they share properties determined by the immutable model partitions) and due to the implementation of the Alloy Analyzer also quicker to find (since the underlying SAT solver does not have to solve the whole formula but is given a partial solution based on the immutable partitions). In fact, the respective partitions of the model in development are made immutable according to a selected sub-instance. This sub-instance can be either artificial (automatically or manually created for the purpose of model immutability only), or derived from a previously-analyzed instance.

The possible use cases of this approach are the following:

- (a) During development, several instances are found, one of them indicating a model flaw. After the model is corrected, it is necessary to re-check not only the particular erroneous instance but also the (in some sense) 'similar' instances in order to assess whether the flaw was actually fixed. After making an appropriate sub-instance of the erroneous instance immutable, the consequently found instances will address the updated parts of the model.
- (b) After a new partition of the model in development was created, it is required to analyze it using 'reasonable' example-driven analysis. After a suitable sub-instance comprising only the previous model partitions (created either from existing instance using Alloy's model finding feature, or manually) is made immutable, the consecutively found instances will introduce variability in the new model partition only and will thus facilitate its analysis. Moreover, they will share a common structure determined by the fixed sub-instance which would make them more comprehensive. Obviously, to achieve required level of confidence, the process has to be repeated for several immutable sub-instances.

In summary, our contribution is:

- **Experiments.** We present a real-life case study that demonstrates the obstacles of example-driven modeling of complex systems and outlines the approach to address them.
- **Multilevel modeling.** We introduce the idea of extending the basic example-driven analysis ap-

proach by systematically fixing a particular partition of the model in development in order to find constrained instances and thus allowing easier analysis and debugging of the model. We refer this method as to multilevel modeling. Moreover, we propose the necessary tool support and associated workflow for the multilevel modeling method.

The rest of the paper is structured as follows: Section 2 presents a real-life case study based on formal model of AADL, Section 3 presents a brief outline of the multilevel modeling method and proposes the associated tooling, Section 4 surveys the related work, and Section 5 concludes the paper and gives future work remarks.

2. Case Study

To illustrate the mentioned obstacles of example-driven analysis in context of large-scale complex systems, we present a case study based on an Alloy specification of the AADL [7] modeling language which is an industrial standard for modeling embedded and real-time component systems.

2.1. Internal Structure of the AADL Model

The presented Alloy model of AADL inherently consists of several distinct parts representing different concerns and different levels of abstraction.

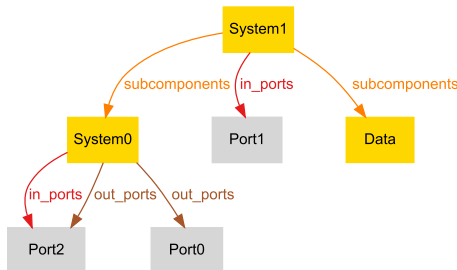

Figure 1: AADL structural model instance.

Specification of Component Structure. The base model part defines the component structure of the AADL and its semantics. This part comprises definition of ports, components, component properties, and component hierarchy. Except for structural component definition, this model part also determines how a valid component refinement can look like, what properties a particular component type can have, etc. The following code example contains a partial specification of AADL component structure including ports and component refinement, specification of System component type, and basic requirements on valid system structure. Figure 1 shows a simple instance of the structural part.

```

abstract sig Component {
  in_ports: set AbstractPort,
  out_ports: set AbstractPort,
  subcomponents: set Component,
  ...
}

fact ComponentNotInSubcomponents {
  all c:Component | c not in c.^subcomponents
}

sig System extends Component { ... }
fact SystemSubcomponents {
  System.subcomponents in
  (System + Data + Process)
}

-- In valid system only a System component can be
-- the top level component
pred ValidSystem {
  all c:(Component - System) |
  one pc:Component |
  c in pc.subcomponents
}
...
}

```

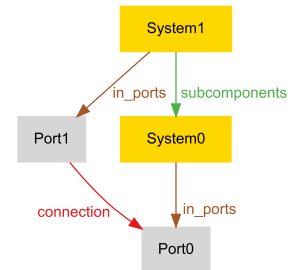

Figure 2: AADL compositional model instance.

Specification of Component Bindings. Based on the structural part, a compositional part is specified. This part comprises specification of port types, valid component composition, and component bindings. Semantically, this part determines valid application architectures. The following code example contains a partial specification of AADL port types and basic requirements on a valid system architecture. Figure 2 shows a simple instance of the compositional model part.

```

abstract sig Port extends AbstractPort {
  connection: set Port
}

-- A valid connection is either
fact {
  all p:connection.Port | some parent:Component |
  all dp:p.connection |
  (
    -- in-port delegation from parent
    -- to a subcomponent
    some cmp:parent.subcomponents |
    (
      p in parent.in_ports
      and dp in cmp.in_ports)
    -- out-port delegation from
    -- a subcomponent to to parent
  ) or (
    p in cmp.out_ports
    and dp in parent.out_ports
  )
}

```

```

) or (
  -- or connection of two subcomponents
  -- from out-port to in-port
  some disj cmp1,
    cmp2:parent.subcomponents |
      p in cmp1.out_ports
      and dp in cmp2.in_ports
)
}

```

```

srcMode: one Mode,
dstMode: one Mode,
owner: one Component
} {
  -- Only transitions between modes from
  -- the same component are allowed.
  owner = srcMode.owner
  owner = dstMode.owner

  -- Only ports from the owner component
  -- can be triggered.
  triggerEventPort in owner.ports
  ...
}

```

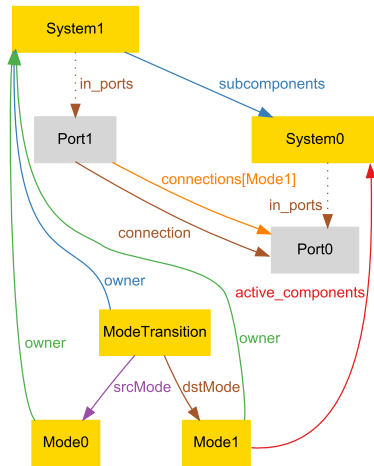

Figure 3: AADL reconfiguration model instance.

Specification of Architecture Reconfigurations. The third model part is the architecture reconfiguration specification. This part comprises specification of valid architecture changes in a system. In AADL, architecture changes are modeled using Finite State Automata (FSA) where each state represents a valid system architecture. These states are called architectural modes since they represent possible versions/modes of the system architecture. Further, the reconfiguration specification captures the transitions between the modes and conditions that have to be met in order to trigger the transitions. The following code example contains a partial specification of AADL modes and mode transitions, as well as their basic properties. Figure 3 shows a simple instance of the reconfiguration model.

```

sig Mode extends AbstractMode {
  active_components: set Component,
  connections: Port -> Port,
  owner: one Component
} {
  active_components in owner.subcomponents

  -- A mode can refer to existing connections
  -- between currently active components only
  all p1, p2: Port | (p1->p2) in connections => (
    (p2 in p1.connection) and
    (p1+p2) in
      (owner.ports + active_components.ports)
  )
  ...
}

sig ModeTransition extends AbstractModeTransition {
  triggerEventPort: set Port,

```

The AADL standard also introduces other model parts such as the platform-definition part or control-and-data-flow part. These are left out from this case study for simplicity.

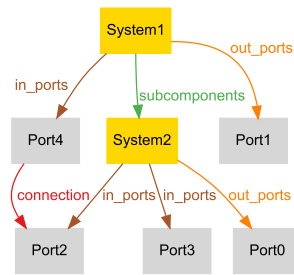

Figure 4: Uninteresting variability in structural part.

2.2. Analysis of the AADL Model

Using the case study presented in Section 2.1, we can illustrate the drawbacks of the example-driven model analysis which were listed in Section 1.

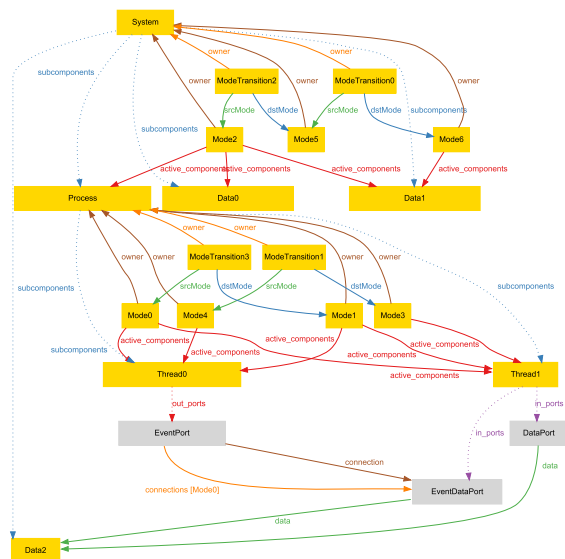

Figure 5: Complex instance of the AADL reconfiguration model.

As for (a), while analyzing a more-elaborate version of the reconfiguration model part, the Alloy Analyzer will likely find complex random instances which are hard to interpret (Figure 5). Moreover, each time the model is updated, the consecutively found instance will probably represent different reconfiguration scenario based on a different architectures (e.g., the actual architecture in Figure 5 significantly differs from the one in Figure 3).

As for (b), the found instances in the instance sequence will likely introduce variability in uninteresting model parts such as variability in port specification while analyzing compositional specification (Figure 4). Naturally, this increases the complexity of analyzing large instances such as the one in Figure 5.

As for (c), Table 1 illustrates the growth of performance demands while developing the individual layers of the AADL model. Measurements were performed on a partial AADL specification similar to the one illustrated in previous section bounded by at most 10 objects for each Alloy signature. The measurements do not include the time needed for generation of the associated SAT formula. It is clear that while developing the full-fledged versions of all model parts, the example-driven analysis would be greatly impeded by the growth of performance demands.

	Min	Max	Average
Structural part	28	71	37.8
Compositional part	135	228	145.6
Reconfiguration part	397	439	410
Reconfiguration part with a fixed sub-instance	40	68	46.5

Table 1: Time required for finding an instance of the individual model parts in ms.

3. Solution

As mentioned in the first section, the multilevel modeling method, targeting example-driven analysis of complex models, is based on a semi-automated process of making a particular model partition immutable according to a selected sub-instance. Not only the immutable model partition makes the found instances more comprehensive (as it enforces certain properties and patterns to be shared by all the instances), but it also reduces the time complexity of the model finding process (as the immutable partition represents a partial solution of the associated SAT formula). As an aside, it may be necessary to repeat the process for several sub-instances in order get the required level of confidence in results of the model analysis.

As an example, in context of the reconfiguration model part presented in the case-study, it is beneficial to fix a particular system architecture (set of architectures) and analyze the reconfiguration model part strictly on this particular architecture (set). Not even it would allow interpreting the found instances and traversing the sequence of instances more easily (as they will be all based on the shared architecture), but the instance finding will also require significantly less time (an example with an immutable component composition featuring 5 components, 10 ports, and 7 connections is illustrated in Table 1, rows 3-4).

3.1. Method Description

The multilevel modeling method consists of several steps: (i) identification of the model partitions and their dependencies, (ii) acquisition/creation of a suitable sub-instance, and (iii) making a model partition immutable according to the sub-instance. In general, all these steps can be performed manually; however, we aim to make them as much automated as possible. In this section, we will outline the possible methods of targeting these individual steps.

Identification of model partitions and their dependencies. The Alloy Analyzer allows splitting the specification into several separate modules and declaring dependencies between these modules. We will exploit this mechanism to address the task of identification of model partitions. A model partition is therefore recognized as an Alloy module. For more fine-grained partitioning of Alloy models, it is possible to introduce independent definition of model partitions and their dependencies for example by explicitly enumerating the relevant Alloy constructs included in each partition.

Acquisition of a suitable sub-instance. An immutable model sub-instance can be obtained in several ways. First, it can be constructed manually. Second, it can be extracted from a previously-found and analyzed instance with assistance of a specialized tool. Third possibility is to employ methods adopted by the related Alloy model synthesis approaches - for example in [5], Java object structures are interpreted as Alloy model instances. In our preliminary experiments, we have employed a variant based on the second case.

Making a model partition immutable according to a sub-instance. There are basically two possible methods of making a model partition immutable. The former is an explicit creation of an Alloy specification which enforces the particular sub-instance. The latter is to use the Kodkod API [9, 10], which allows to provide the underlying SAT solver with a particular sub-instance directly.

Although the usage of the Kodkod API is considered more effective, the former approach brings noticeable performance improvement as well (Table 1, rows 3-4). Since an Alloy specification is transformed into a SAT formula, making a sub-instance immutable corresponds to assigning some of the variables of the corresponding SAT formula. Technically, the Alloy specification enforcing a particular sub-instance causes immediate assignment of some of the SAT variables (during BCP in DPLL-based [1] SAT solvers [2]). In our preliminary work, we have adopted the former method because of its comprehensibility and implementation simplicity.

3.2. Tooling and Workflow Proposal

In this section, we propose required workflow and tooling for the automated multilevel modeling support in the Alloy Analyzer.

As the identification of model parts is based on the Alloy modules, it is not necessary to provide any additional support for this step, since the Alloy library already provides all the required support. Since no user interaction is required in this step, it does not influence the workflow.

Concerning acquisition of suitable sub-instances, the idea is to integrate the support for selection of sub-instances directly into the current Alloy instance visualization tool. The selection of immutable sub-instance can be then performed either directly, by selecting the immutable parts of the current instance, or indirectly, by selecting the variable parts of the current instance (everything except the selected parts is considered fixed). It is also necessary to support storage of the selected sub-instances.

As for making a sub-instance immutable, the Alloy specification enforcing a sub-instance can be generated from the sub-instance XML description provided by the Alloy Analyzer. The specification can be automatically combined with the original model so that the set of possible instances will be constrained to the ones sharing the sub-instance. The only change of the workflow caused by this step is the selection of a stored sub-instance before the actual instance finding. A prototype of the supporting tool is currently being developed.

3.3. Applicability of the Method

The proposed method is applicable only for a particular class of Alloy models, i.e. models with an inherent internal structure. In general, the model is required to be composed from inter-dependent parts (one part can employ constructs defined in another part), where the dependencies between the individual model parts have

to form an acyclic oriented graph (typical case is a layered model structure, i.e., a hierarchy).

For example, as illustrated in Section 2, every common component model is eligible for the multilevel modeling method. In general, inherent structure of a component model comprises three parts: a structural specification of components (e.g., provided/required interfaces, interface types), a compositional specification (e.g., component bindings), and a specification of architectural changes (e.g., reconfigurations of component bindings).

Model parts typically represent the individual concerns and levels of abstraction of the modeled system. Moreover, these parts are typically developed separately in a particular order (e.g., in case of a component system the parts are developed in the same order as listed in the previous paragraph).

4. Related Work

In [5], the authors use a set of instances to automatically generate an executable Alloy model, which represents the properties shared by the instances. The instances are determined by given Java object structures. In comparison with the multilevel modeling method, this work employs the given instances to completely synthesize a fitting model, whereas in our case the instances are employed for synthesis of an extension of an existing model. In both cases, the goal is to enforce the shared properties of the instances in the resulting Alloy model.

In [6], the author presents a method called Modeling by Example, based on automated model refinement. MBE generates near-hit and near-miss examples for the user to decide whether they should be included or excluded in the target Alloy model. The model is continuously refined according to these choices. In some sense, the MBE method represents an enhancement of the original example-driven model analysis by automated processing of the user decisions. Similar to the multilevel modeling method, the goal is to generate instances which carry meaningful information with respect to the model in development (i.e., instance without uninteresting variability). However, in context of multilevel modeling the 'uninteresting' instances have to be eliminated manually and the method itself serves only for easier identification of such instances.

In [8], the goal is to speed-up the Alloy model verification with respect to a particular property by separate verification of programmatically-identified model parts and composition of the verification results. Compared to the proposed method, the method in [8] is rather tool-

oriented than model-developer-oriented; i.e., it aims for speeding-up an automated process, whereas our approach aims for speeding-up a manual process. Still, both methods exploit separate analysis of individual model parts.

5. Conclusion and Future Work

Alloy has been gaining popularity due to its ability to provide rapid feedback - by employing the example-driven model analysis. However, development of Alloy models of large-scale complex systems introduces various problems which are reducing this feedback. In this paper, we have described these problems. We have also provided a real-life case study for illustration. To fight these problems, we proposed a simple developer-oriented method, applicable for specific class of models (i.e., models with an inherent internal structure), based on making particular model parts immutable in order to allow constrained example-driven analysis of the model part of interest. The proposed method allows focusing on development of a particular model part and thus increases the feedback of the example-driven analysis. Currently, we are at the stage of implementing the first prototype of a tool which integrates the multilevel modeling into the standard Alloy Analyzer's workflow. The tool is based on programmatic transformation of an XML description of a given sub-instance into a corresponding Alloy specification. As a future work, we plan to implement a more elaborate tool which would allow quick and interactive diagram-based construction of sub-instances both from scratch and from previously found instances (an interesting option is to allow selection of the variable parts in a given instance instead of the immutable parts). We also plan to employ the Kodkod API to enforce the given sub-instances.

References

- [1] M. Davis, G. Logemann, and D. Loveland, "A machine program for theorem-proving.", *Commun. ACM* 5, 7 (July 1962), pp. 394-397, 1962
- [2] N. Eén and N. Sorensson, "An extensible SAT-solver. Theory and Applications of Satisfiability Testing", pp. 502-518, 2004
- [3] D. Jackson, "Alloy: a lightweight object modeling notation.", *ACM Transactions on Software Engineering and Methodology (TOSEM)* 11, No. 2, pp. 256-290, 2002.
- [4] D. Jackson, "Software Abstractions: Logic, Language, and Analysis." MIT Press, Cambridge, MA, USA, and London, England, 2006.
- [5] S. Khurshid, M. Z. Malik, and E. Uzuncaova, "An Automated Approach for Writing Alloy Specifications Using Instances." *Second International Symposium on Leveraging Applications of Formal Methods, Verification and Validation (isola 2006)*, pp. 449-457, 2006.
- [6] L. Mendel, "Modeling by example." *Master thesis*, MIT, MA, USA, 2007.
- [7] SAE, "Architecture Analysis & Design Language (AADL)", AS-5506, 2004
- [8] A. Shaikh, R. Clarisó, R., U. K. Wiil, and N. Memon, "Verification-driven slicing of UML/OCL models." *Proceedings of the IEEE/ACM international conference on Automated software engineering*, pp. 185-194, ACM, 2010.
- [9] E. Torlak and G. Dennis, "Kodkod for Alloy users." *First ACM Alloy Workshop*, Portland, Oregon, 2006.
- [10] E. Torlak and D. Jackson, "Kodkod: A relational model finder." *Tools and Algorithms for the Construction and Analysis of Systems*, pp. 632-647, Springer, 2007.

Detekce zvýšených ztrát v distribuční síti zemního plynu

doktorand:

MGR. ONDŘEJ KONÁR

Ústav informatiky AV ČR, v. v. i.
Pod Vodárenskou věží 2
182 07 Praha 8

konar@cs.cas.cz

školitel:

DOC. ING. EMIL PELIKÁN, CSC.

Ústav informatiky AV ČR, v. v. i.
Pod Vodárenskou věží 2
182 07 Praha 8

pelikan@cs.cas.cz

obor studia:

Inženýrská informatika v dopravě a spojkách

Abstrakt

Článek pojednává o problematice detekce zvýšených ztrát v distribuční soustavě. Je prezentována problematika přepravy, měření a odhadu spotřeby zemního plynu ve světě, s důrazem na situaci v ČR. Dále je prezentován projekt, v rámci něhož je zkoumána problematika detekce ztrát na vybraných uzavřených lokalitách v rámci distribuční sítě RWE GasNet, s.r.o.

Úvod

Pro obchodníky se zemním plynem představují ztráty v distribuční soustavě ztráty finanční. Proto je pochopitelné, že je snaha ztráty minimalizovat. Bohužel, jak bude podrobněji popsáno v dalších odstavcích, jsou v případě zemního plynu ztráty prakticky neměřitelné. Přesné (nebo přinejmenším uspokojivě přesné) změření výše ztrát by znamenalo osazení všech vstupů a výstupů v síti podrobným průběhovým měřením, například v denním rozlišení. Toto řešení je však v současné době velice nákladné (obnáší jednorázové náklady na pořízení měřidel, ale také dlouhodobé náklady na průběžné zpracování obrovského množství naměřených údajů). Z tohoto důvodu je obvyklé využití matematických modelů spotřeby plynu. V dalším textu je naznačena situace v ČR, popsán způsob přepravy a distribuce zemního plynu, měření jeho spotřeby a odhad spotřeby pomocí matematických modelů. Dále je popsán projekt, jehož cílem je detekovat zvýšené ztráty ve vybraných uzavřených lokalitách v rámci distribuční sítě společnosti RWE GasNet, s.r.o. V rámci tohoto projektu jsou vyvíjeny metody využití níže popsaných matematických modelů k identifikaci oblastí se zvýšenými ztrátami.

1. Přeprava a distribuce zemního plynu v ČR

1.1. Zdroje zemního plynu

V České republice existují čtyři typy „zdrojů“ zemního plynu. Jedná se o dovoz, vlastní těžbu, zásobníky a akumulaci. Hlavním zdrojem plynu je dovoz, ostatní zdroje jsou spíše podpůrné (vlastní těžba pokrývá dle Plynárenské příručky [25] řádově jednotky procent spotřeby v ČR). Průtok importovaného plynu je v průběhu roku relativně stálý, naproti tomu nerovnoměrnost spotřeby v rámci roku je obrovská. To je dáno skutečností, že nezanedbatelná část zemního plynu je spotřebována pro účely vytápění. Spotřeba v zimě pak činí až desetinásobek letní spotřeby.

Tyto výkyvy ve spotřebě je potřeba vyrovnávat. V zásadě existují dvě možnosti:

1. nerovnoměrná těžba zdrojů,
2. využití zásobníků.

V ČR pochopitelně připadá v úvahu pouze možnost 2 vzhledem ke zmíněné zanedbatelnosti vlastních těžebních zdrojů. Zásadní roli při vyrovnávání nerovnoměrnosti spotřeby v průběhu roku tedy hrají zásobníky. Plynárenská příručka [25] rozlišuje dva typy zásobníků podle způsobu využití:

sezónní zdroje – ty se vyznačují velkou uskladňovací kapacitou, těžba, resp. vtlačení, je však u těchto zásobníků relativně pomalá; jedná se především o tzv. aquiferové zásobníky (přírodní zásobníky podzemní vody jsou využity pro skladování plynu) a vytěžená ropná či plynová ložiska,

špičkové zdroje – slouží především ke krytí špičkové spotřeby (nejchladnější dny), ale také k vyrovnávání krátkodobých výkyvů; vyznačují se

menší skladovací kapacitou, ale rychlejší těžbou; jedná se např. o solné či umělé kaverny, plynovody, zásobníky zkapalněného plynu (LNG – v ČR nevyužíváno).

Zvláštním typem zásobníku je akumulace plynu v potrubí. Akumulace soustavy je definována jako celkový objem plynu v přepravní soustavě. Vzhledem k plynnému skupenství může tento objem (a spolu s ním i tlak) poměrně výrazně kolísat. Toho lze do jisté míry využít k regulaci nerovnoměrnosti spotřeby v rámci dne.

1.2. Přeprava zemního plynu

Ve světě existují dva typy přepravy zemního plynu:

1. potrubní přeprava,
2. přeprava zkapalněného plynu (LNG) tankery.

V ČR je pochopitelně využíván pouze první způsob přepravy. Přeprava pomocí tankerů je však i ve světě až na výjimky kombinována s potrubní přepravou.

Přepravní síť zemního plynu v České republice se skládá z několika kategorií plynovodů:

nízkotlaké plynovody – pracovní tlak do 5 kPa včetně, slouží pro domovní rozvody případně distribuci v menších obcích, tlak plynu není třeba před použitím ve spotřebičích dále upravovat,

středotlaké plynovody – pracovní tlak do 400 kPa včetně, využívají se při potřebě vyšší kapacity a pružnosti sítě (při připojení na středotlaký rozvod si musí odběratel opatřit regulátor k úpravě tlaku plynu na hodnotu potřebnou pro provoz spotřebičů),

vysokotlaké plynovody – pracovní tlak do 4 MPa včetně, slouží především pro vnitrostátní dálkovou dopravu plynu do jednotlivých plynofikovaných obcí,

velmi vysokotlaké plynovody – pracovní tlak nad 4 MPa, slouží především pro mezinárodní dálkovou dopravu plynu,

Dovážený plyn z Ruska vstupuje na území ČR v předávací stanici Lanžhot. Ze systému dálkové přepravy se dostává zemní plyn (ta část, která není exportována do dalších zemí) přes předávací stanice vnitrostátní soustavy. V těchto předávacích stanicích se také upravuje tlak plynu na hodnotu obvyklou v dané vnitrostátní síti. Vnitrostátní síť je zemní plyn dopravován

do měst a obcí, případně přímým odběratelům (typicky velkým průmyslovým podnikům).

1.3. Měření spotřeby zemního plynu

Údaje o množství přepraveného plynu jsou pochopitelně důležité jak pro provozovatele distribuční sítě (poplatky za přepravu), tak pro obchodníky s plynem (představa o množství spotřebovaného plynu). Předávací stanice jsou osazeny průběhovými měřeními, které poskytují hodinové hodnoty množství plynu, který těmito body protéká. Spotřeba plynu jednotlivých odběratelů je taktéž měřena, aby mohla být na základě měření provedena fakturace odebraného plynu a poplatků za přepravu. Za předpokladu konstantní akumulace (jejíž změny lze odhadnout pomocí měření tlaku v předávacích bodech) odpovídá rozdíl mezi vstupním a spotřebovaným množstvím plynu ztrátám v daném úseku distribuční soustavy.

Tyto ztráty však nelze v žádném okamžiku přesně vypočítat, a to ani když zanedbáme vliv akumulace. Problém je na straně měření spotřeby. Jednotlivá odběrná místa jsou (zpravidla dle průměrné roční spotřeby) osazena jedním ze tří typů měřidel [30]:

měřidlo typu A – průběhové měřidlo s dálkovým přenosem, naměřené hodinové hodnoty jsou průběžně odesílány na dispečink,

měřidlo typu B – průběhové měřidlo bez dálkového přenosu, naměřené hodinové hodnoty jsou zpravidla jednou měsíčně ručně vyčítány pomocí přenosného zařízení,

měřidlo typu C – bez průběhového měření, je zaznamenáno pouze celkové množství odebraného plynu, to je v určitých intervalech (jeden až osmkrát měsíčně) odečítáno, spotřeba se určí rozdílem dvou po sobě jdoucích odečtených hodnot.

Denní hodnoty ztrát by bylo možno přesně určit pouze v případě, že by všechna odběrná místa byla osazena měřením typu A, případně měřením typu B (pak by bylo možno ztráty určovat zpětně vždy na konci kalendářního měsíce). Osazení tímto typem měření je však velmi nákladné (pořizovací cena měřidla se pohybuje v desítkách tisíc korun). Proto je většina odběrných míst, především u domácností a maloodběratelů (tj. zákazníků s ročním odběrem do 630 MWh), ale i některých středních odběratelů (zákazníků s ročním odběrem mezi 630 a 4200 MWh), osazena měřením typu C.

K získání údajů o spotřebě z měřidla typu C je zapotřebí provést fyzický odečet. Ten spočívá v odečtení

stavu plynoměru pověřeným pracovníkem a zápisu do databáze. Pořízení fyzických odečtů všech zákazníků v jednom dni je velmi technicky i ekonomicky náročné. Z tohoto důvodu většina dodavatelů plynu v České (ale i Slovenské) republice přistoupila k tzv. cyklickým odečtům. V každém měsíci daného roku je odečtena určitá část zákazníků (rozložení není zcela rovnoměrné s ohledem na obtížnější přístup k plynůměrům v letních měsících z důvodů častých dovolených). Při plánování odečtových tras přitom musí být zajištěno, aby interval mezi dvěma odečty daného zákazníka nebyl delší než 18 měsíců. Typicky je délka intervalu mezi jednotlivými odečty roční, u větších zákazníků však není výjimkou ani měsíční odečítání.

Důsledkem cyklického odečítání je skutečnost, že v žádném okamžiku není přesně znám celkový objem spotřebovaného plynu v daném úseku distribuční soustavy. Z toho plyne, že nelze přesně určit ani ztráty. Pomineme-li v současné době ekonomicky neprůchodnou variantu osazení všech zákazníků měřením typu A, je pro vybrané úlohy (určení ztrát, množství nevyfakturovaného plynu, obchodní bilance atd.) nutné použít odhad. V následující kapitole je popsáno několik matematických modelů používaných k odhadu spotřeby zákazníků s měřením typu C v různých situacích.

2. Modelování spotřeby zemního plynu

Vzhledem ke komplikacím při distribuci zemního plynu popsaným v kapitole 1 (rovnoměrný dovoz, nerovnoměrný odběr, obtížné skladování, nákladné měření) je modelování spotřeby zemního plynu velmi důležitým nástrojem distribučních společností. Modely popsané v literatuře mají několik společných znaků. Typicky je součástí modelu klasifikace zákazníků na základě jejich odběratelského chování. Nejjednodušší formou je klasifikace podle výše odběru (např. maloodběratel – střední odběratel – velkoodběratel, případně jemnější ceníková pásma), dále se ale také používají klasifikátory jako je způsob užití zemního plynu (vaření, ohřev vody, vytápění, technologický odběr) případně typ podniku (výrobní prostory, služby, zemědělství atd.) a další. Volba vhodné klasifikace je náročná a závisí mimo jiné také na technických možnostech konkrétní distribuční společnosti a správnosti údajů v její databázi. Výsledné třídy by měly být pokud možno homogenní v ročním průběhu spotřeby, zároveň by však měly být od sebe zřetelně odlišitelné. Nezanedbatelným požadavkem je také dostatečné zastoupení zákazníků v každé třídě.

Modely popsané v literatuře využívají nejruznější vysvětlující proměnné. Typicky bývají zahrnuty meteo-

rologické veličiny. Již v práci [1] byla popsána závislost spotřeby na teplotě. Uvažovány jsou však i další meteorologické veličiny, jako je rychlost a směr větru, sluneční svit, atmosférický tlak či srážky. Teplotní odezva bývá často velmi komplexní, minimálně se uvažuje rozdílná teplotní závislost pro teplé a studené dny. Existuje koncepce tzv. „heating degree days“, která spočívá v zanedbání vlivu teploty na spotřebu nad určitou stanovenou mezí [12, 27]. Podobná koncepce je použita například i u modelu GAMMA používaného v ČR [13, 28]. Dalšími běžně používanými prediktory jsou kalendářní efekty jako je den v týdnu, resp. rozlišení na pracovní a nepracovní den, svátky, vánoce, velikonoce a další. Používány jsou také jiné veličiny, jako je např. cena plynu, resp. ropy, s níž je cena plynu vázaná [24].

Dále je možné dělit modely podle způsobu jejich využití:

1. Odhad individuální spotřeby:

- rozpočet známé spotřeby do kratších časových úseků (například při změně ceny plynu, ke které došlo mezi dvěma řádnými odečty měřidla typu C),
- odhad spotřeby za určitý časový úsek v minulosti (například v případě, kdy je ze zákona nutno vystavit zákazníkovi fakturu, ale nejsou k dispozici údaje z měření, pak je třeba odhadnout spotřebu od posledního odečtu do okamžiku fakturace),
- předpověď individuální spotřeby v budoucnu.

2. Odhad spotřeby větších skupin zákazníků:

- odhad nevyfakturovaného plynu (celkové množství plynu, které bylo spotřebováno, ale nebylo fakturováno),
- bilance v soustavě (odhad ztrát či jejich rozpočet mezi jednotlivé účastníky trhu),
- predikce celkové spotřeby celého zákaznického kmene.

Rozpočet (případ 1a) je úloha s největší dostupností potřebných údajů. Z tohoto důvodu je svým způsobem jednodušší než zbývající úlohy. Problémy 1b a 1c se liší především v dostupnosti hodnot vysvětlujících proměnných, např. průměrné teploty vzduchu. Ve světové literatuře je nejvíce publikací věnováno predikci celkové spotřeby (2c) [9, 10, 12, 17, 21–24], méně pak tvorbě tzv. typových diagramů dodávky (TDD), tj. úloze 2b [11].

Různé úlohy pochopitelně mohou někdy být řešeny pomocí stejného modelu, obecně však nelze zkonstruovat model, který optimálně řeší všechny. Použití jednotného

přístupu k řešení různých problémů je vždy kompromisem. Nicméně vzhledem k přirozené tendenci minimalizovat náklady je tento požadavek v praxi běžný.

K řešení úlohy 1a se dříve v ČR používala tzv. otovpová křivka [29]. Jednalo se o sadu dvanácti měsíčních koeficientů, která udávala empiricky zjištěný podíl daného měsíce na spotřebě plynu při vytápění. Pro zákazníky s malou spotřebou, u nichž se vytápění plynem nepředpokládalo, se rozpočet prováděl rovnoměrně. V dnešní době se používá k rozpočtu používá model TDD [30]. Ten se nyní užívá i k náhradě odečtu (úloha 1b). Úloha predikce individuálních spotřeb (1c) byla řešena pro zákazníky s měřením typu B např. v publikaci [3].

Pro odhad nevyfakturované složky plynu (2a) byl konstruován nelineární regresní model GAMMA [8, 13, 28]. Pro účely zúčtování odchylek (2b) slouží poněkud složitější model TDD třídy GAM (generalized additive models) [4, 5, 30]. Řešení problematiky odhadu ztrát se v ČR teprve připravuje. Predikcí celkové spotřeby (2c) se zabýval např. systém ELVÍRA [18, 19], který byl založen na metodách analýzy časových řad.

V následujících odstavcích jsou podrobněji popsány modely GAMMA a TDD pro odhad spotřeby zemního plynu vyvíjené v ÚI AV ČR ve spolupráci s účastníky trhu s plynem v ČR.

2.1. Model GAMMA

Model GAMMA [13, 28] byl primárně určen pro odhad nevyfakturovaného plynu [8]. O možném využití k dalším praktickým úlohám pojednává článek [2]. Je založen na odhadech individuálních spotřeb, které jsou posléze agregovány po stanovených třídách zákazníků. Celkové množství nevyfakturovaného plynu se určí jako součet individuálních odhadů zákazníků v dané zóně. Model byl v letech 2004 až 2009 rutinně používán v Západočeské plynárenské, a.s. (dále jen ZČP). Od roku 2010 přebrala model firma RWE GasNet, s.r.o. (dále jen RWE), která uvažuje o jeho použití pro odhad ztrát v tzv. uzavřených lokalitách. Tato problematika je podrobněji popsána v kapitole 3.

Odběrná místa jsou klasifikována dle typu klienta (domácnost, malooběr) a dle charakteru odběru (vaření, ohřev vody, vytápění, technologický odběr). Uvažovány jsou všechny kombinace prvních tří charakterů (celkem 7 tříd pro domácnosti a 7 tříd pro malooběr) a dvě třídy pro technologický odběr (čistě technologický a v kombinaci s vytápěním). Celkem máme tedy k dispozici 16 zákaznických tříd. Vybrané parametry modelu jsou společně všem zákazníkům dané třídy.

Základním časovým rozlišením modelu GAMMA je den, typické použití je však pro odhad spotřeby za delší časové období (1 až 18 měsíců). Jako vysvětlující proměnné se používají průměrné denní teploty vzduchu v daném regionu a také dlouhodobý teplotní normál. Model je relativně jednoduchý s ohledem na to, že pro odhad parametrů nejsou a nikdy nebyla k dispozici denní data. Pro odhad parametrů se využívá kombinace mimořádných měsíčních odečtů náhodně vybraných cca 1700 zákazníků a dále údajů z řádných (zpravidla ročních) odečtů celého zákaznického kmene (očištěného od podezřelých hodnot).

Pro spotřebu Y_{ikd} zákazníka i třídy k ve dni d je definován následující nelineární regresní model:

$$Y_{ikd} = \mu_{ik}\Phi_{kd} + \varepsilon_{ikd}, \quad (1)$$

kde

μ_{ik} je individuální parametr zákazníka i určující globální (časově nezávislou) hladinu jeho spotřeby,

Φ_{kd} je systematická část modelu, společná pro třídu k ,

ε_{ikd} je náhodná složka, u níž předpokládáme nulovou střední hodnotu a rozptyl úměrný střední hodnotě denní spotřeby, tj. členu $\mu_{ik}\Phi_{kd}$.

Individuální parametr μ_{ik} je odhadován metodou vážených nejmenších čtverců s využitím řádných odečtů daného zákazníka až tři roky do historie. Délka využívané historie je také jedním z parametrů modelu specifických pro zákaznickou třídu. V minulosti bylo také experimentováno s odhadem parametru μ_{ik} pomocí metod NLME (nelineární modely s smíšenými efekty) [14, 15]. Tento přístup však nakonec nebyl v provozu využit z důvodu výrazně vyšší výpočetní náročnosti.

Systematická část Φ_{kd} má následující tvar:

$$\Phi_{kd} = Z_{kd}(\Psi_d \cdot \exp\{-\gamma_k f(T_d, N_d)\} + p_k) + (1 - Z_{kd})q_k, \quad (2)$$

kde

Z_{kd} je indikátorová proměnná, je rovna 1, jestliže je průměrná teplota ve třech posledních dnech ($d, d-1, d-2$) nižší než 14°C (indikuje zimní období) nebo je třída k tzv. „neotopová“ (zákazníci nevyužívají plyn k vytápění), v opačném případě má Z_{kd} hodnotu 0,

Ψ_d je sezónní složka s roční periodicitou společná všem třídám,

γ_k je parametr udávající míru teplotní závislosti,

$f(T_d, N_d)$ je funkce průměrné denní teploty T_d a normálové teploty N_d tvaru

$$f(T_d, N_d) = T_d - N_d, \quad (3)$$

p_k je stálá (nesezónní) složka spotřeby v „zimním“ období,

q_k je stálá složka spotřeby v „letním“ období (pouze pro „otopové“ třídy).

Indikátorová proměnná Z_{kd} slouží k „přepínání“ zimního a letního provozu u zákazníků využívajících plyn k vytápění. U těchto zákazníků se ukázalo, že použití jednotného tvaru po celý rok způsobuje neuspokojivou přesnost odhadu spotřeby v letních měsících. Použití třídních průměrů teplot místo pevného časového určení částečně řeší problém tzv. přechodových období, tj. období začátku a konce topné sezóny, které nastávají v každém roce jindy. Tato období jsou zároveň velice citlivá, neboť je zde zvýšená variabilita ve spotřebě mezi zákazníky daná rozdílným zákaznickým chováním.

Sezónní složka Ψ_d byla jednorázově odhadnuta neparametricky z měsíčních hodnot vstupu do distribuční sítě ZČP. Měsíční hodnoty byly posléze interpolovány pomocí polynomu. Tak vznikly denní hodnoty Ψ_d . Tento odhad je následně používán jako vysvětlující proměnná v nelineárním regresním modelu daném rovnicemi (1) a (2), tj. je pro daný den v roce považován za pevnou konstantu. Důvodem tohoto postupu byla skutečnost, že v době návrhu modelu nebyla k dispozici jiná data s dostatečně jemným časovým rozlišením.

Tvar teplotní funkce $f(T_d, N_d)$ byl zvolen pro jednoduchost a snadnou interpretovatelnost. Jak skutečně, tak normálové teploty jsou však před výpočtem shora ořezány v hodnotě 14°C. Důvodem je experimentální zjištění, že přibližně v této hodnotě zaniká teplotní závislost spotřeby.

Ostatní parametry modelu, tj. γ_k , p_k a q_k jsou odhadovány metodou nejmenších absolutních odchylek s využitím údajů z mimořádných měsíčních měření. V případě nedostatečného množství mimořádných měření se použijí řádné odečty. Tato metoda byla zvolena, neboť poskytovala stabilnější odhady než tradičnější metoda nejmenších čtverců.

Modularita modelu umožňuje provádět dílčí změny bez výraznějšího narušení struktury, a tudíž i procesu odhadu parametrů. Chceme-li například změnit tvar teplotní odpovědi modelu, lze prostě zaměnit funkci f jinou vhodnou funkcí. Při vývoji modelu byl kladen důraz

na maximální přesnost odhadu celkového nevyfakturovaného plynu, tj. odhadu spotřeby relativně velkého celku za relativně dlouhé období. Pro použití k detekci zvýšených ztrát může být nutné provést určité modifikace.

3. Detekce zvýšených ztrát

V současné době probíhá ve spolupráci s distribuční společností RWE GasNet, s.r.o., vývoj metodiky detekce anomálního časového průběhu ztrát v uzavřené lokalitě s využitím modelu GAMMA popsaného v odstavci 2. Příkladem atypického průběhu může být krátkodobé zvýšení ztrát (např. při havárii) případně dlouhodobě vyšší ztráty (např. při ilegálním odběru). Součástí projektu je získání údajů z několika desítek uzavřených oblastí v rámci celé její distribuční sítě (prakticky celá ČR s výjimkou Prahy a Jihočeského kraje).

Uzavřenou lokalitou se rozumí část distribuční soustavy, která má jeden nebo více měřených vstupů a výstup pouze u koncových odběratelů. Typicky se jedná o několik menších obcí (řádově 500-1000 odběratelů). Příklad takové lokality je v podobě mapy uveden na obrázku 1.

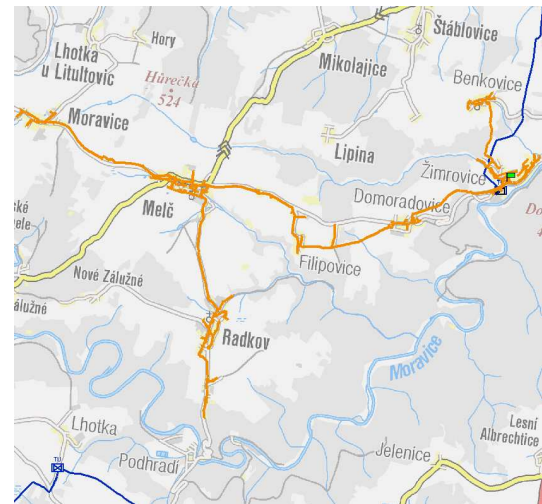

Obrázek 1: Příklad uzavřené lokality.

Veškerý plyn, který vteče do oblasti by měl být spotřebován. Rozdíl mezi spotřebou plynu a přítokem do soustavy představuje ztráty v soustavě. Problém je v tom, že spotřebu (a tudíž ztráty) na rozdíl od vstupu do soustavy nelze v praxi změřit v dostatečném časovém rozlišením, jak bylo popsáno v kapitole 1.

Odhad denních ztrát získáme pomocí odhadu spotřeb (např. modelem GAMMA) tak, že od měřeného

vstupního objemu v daném dni odečteme měřenou spotřebu velkých zákazníků a odhadnutou spotřebu malých zákazníků. Výsledkem je pro každou oblast řada denních odhadů ztrát.

3.1. Data

Pro řešení úlohy jsou k dispozici následující datové soubory:

1. Data z vybraných uzavřených oblastí:
 - a) denní měřené objemy vstupujícího plynu,
 - b) denní měřené spotřeby všech velkoobdobatelů a středních odběratelů,
 - c) fakturační odečty všech odběratelů v dané oblasti (typicky roční interval).
2. Průměrné denní teploty v jednotlivých krajích (zdroj ČHMÚ) od roku 1999.
3. Podpurná data:
 - a) mimořádné měsíční odečty cca 1700 zákazníků ze západních Čech,
 - b) fakturační odečty zákaznického kmene RWE.

Objem zpracovávaných dat je poměrně rozsáhlý. Kromě toho jsou data v poměrně syrovém stavu. Zkušenosti s dosavadní implementací modelu GAMMA v západních Čechách ukazují, že model může sloužit také jako nástroj k automatizovanému hledání chyb v datech. To však pochopitelně nevede k odstranění všech chyb a je třeba kombinovat s „ručním“ hledáním.

Příkladem využití modelu GAMMA pro hledání chyb v datech je čištění dat z mimořádných měsíčních odečtů. Označíme-li Y_{im} měsíční spotřebu zákazníka i v měsíci m , \hat{Y}_{im} její odhad modelem GAMMA a M celkový počet měřených měsíců, zavedeme pro každého zákazníka a každý měsíc penalizaci

$$P_{im} = \begin{cases} 1 & \Leftrightarrow \left(\frac{|Y_{im} - \hat{Y}_{im}|}{Y_{im}} > 2 \right) \& \\ & \left(|Y_{im} - \hat{Y}_{im}| > 0,75 \frac{1}{M} \sum_{t=1}^M Y_{it} \right) \\ 0 & \text{jinak.} \end{cases} \quad (4)$$

Jako podezřelého pak označíme zákazníka, pro kterého platí $\sum_{m=1}^M P_{im} > \frac{M}{2}$. Validita měření u podezřelých zákazníků je následně ověřována poskytovatelem dat.

3.2. Řešení

Hlavním úkolem je porovnávat odhady ztrátových procesů v jednotlivých měřených oblastech. Cílem je

vytipovat oblasti se zvýšeným objemem ztrát a ty pak osadit průběhovými měřeními, a to ve všech bodech. Primárně bude vyměněno měřidlo na vstupu z důvodu vyloučení jeho případné systematické chyby. Pokud bude po určeném čase stav přetrvávat, budou průběhovými měřidly osazena všechna odběrná místa, aby bylo možno ztráty změřit. Poté bude následovat vyhodnocení reálných (naměřených) ztrát oproti jejich odhadům pomocí modelu GAMMA.

Úloha detekce ztrát je komplikována několika problémy, které vyžadují nestandardní postupy:

1. Chyba odhadu není a nikdy nebude pozorována. V daném dni je totiž měřen pouze vstup do soustavy, nikoli výstup. Spotřeba zákazníků v daném dni je odhadována modelem GAMMA. Rozdíl mezi měřeným vstupem a odhadnutou spotřebou představuje odhad ztrát.
2. Do hry vstupuje velmi mnoho proměnných, které mohou více či méně ovlivnit průběh odhadu ztrát:
 - a) různá skladba zákazníků v jednotlivých lokalitách (počet i spotřeba),
 - b) různé odběratelské zvyklosti v různých regionech (např. různá pracovní doba, různé nároky na teplotu v bytě, v domě apod.),
 - c) různé povětrnostní podmínky (chladnější a teplejší regiony),
 - d) vlastní chyba použitého matematického modelu a její variabilita (v čase i mezi regiony).

Tyto faktory je třeba brát v úvahu a snažit se odfiltrovat jejich vliv před vlastní diagnostikou.

3. Pojem „zvýšené ztráty“ není zcela jasně definován. Před hledáním detekčních metod bude třeba dobře rozmyslet, co vlastně chceme detekovat. V zásadě jde o problém detekce odlehých pozorování, ovšem s tím, že máme dva druhy odlehlostí:
 - a) odlehlost uvnitř lokality (např. při krátkodobém černém odběru, úniku při havárii apod.),
 - b) odlehlost mezi lokalitami (např. při dlouhodobém černém odběru, ale také např. při odlišné skladbě zákazníků).

Není vyloučeno, že bude třeba použít rozdílných metod pro detekci různých typů odlehlostí.

4. První výsledky

V současné době jsou k dispozici pro testování údaje z 9 uzavřených lokalit (v budoucnu by se měl tento počet rozšířit na řádově desítky lokalit). Z důvodu důvěrnosti používaných dat budou v dalším textu lokality rozlišeny číselnými kódy. V těchto lokalitách byla odhadnuta spotřeba všech zákazníků modelem GAMMA a porovnána s celkovým vstupem do soustavy (po odečtení průběhově měřených zákazníků).

4.1. Kritérium

Proces detekce musí být při případném provozním použití plně automatický (nelze spoléhat na ruční procházení stovek až tisíců průběhů spotřeb). Z toho důvodu je klíčová volba kritéria pro hodnocení ztrát v dané lokalitě. V zásadě je třeba vytvořit uspořádání lokalit podle zvoleného kritéria a posléze věnovat zvýšenou pozornost „nejhorším“ lokalitám.

Přirozenou cestou je využívat odchylky modelovaných spotřeb od měřeného vstupu (které představují odhad ztrát v dané lokalitě). Vzhledem k tomu, že prioritní je odhalit ztráty dlouhodobé, je vhodné v první fázi volit kritéria zohledňující chování na delším časovém úseku.

Dále je třeba volit mezi kritérii absolutními a relativními. Výhodou absolutních kritérií, jako např.

$$Err_1(l) = \frac{1}{|\tau|} \sum_{t \in \tau} |\hat{Y}_{tl} - Y_{tl}|, \quad (5)$$

kde

\hat{Y}_{tl} je odhad celkové spotřeby neprůběhově měřených zákazníků za den t v lokalitě l ,

Y_{tl} je měřená hodnota vstupu do lokality l ve dni t po odečtení spotřeb všech průběhově měřených zákazníků,

τ je vyhodnocované období (v současné době celé měřené období od 1.6.2007 do 31.8.2010),

$|\tau|$ je počet dní období τ ,

je přímá vazba na výši případných finančních ztrát (i přes relativně komplikovaný systém cen plynu pro různé zákazníky lze přinejmenším odhadnout, o kolik peněz by společnost přicházela za předpokladu, že by odhad ztrát byl přesný). Distribuční společnosti však typicky zajímá také vztah k nějakému celku. To vede k použití různých typů relativních kritérií.

Například kritérium

$$Err_2(l) = 100 \cdot \frac{\sum_{t \in \tau} |\hat{Y}_{tl} - Y_{tl}|}{\frac{1}{L} \sum_{l=1}^L \sum_{t \in \tau} Y_{tl}}, \quad (6)$$

kde L je celkový počet vyhodnocovaných lokalit, vede ke stejnému uspořádání lokalit jako kritérium (5), hodnoty kritéria jsou však vztažené k celkové průměrné denní spotřebě všech vyhodnocovaných lokalit. Pochopitelně z hlediska uspořádání není hodnota normovací konstanty důležitá, normování je použito s ohledem na interpretovatelnost výsledků.

Kritérium (6) však „znevýhodňuje“ velké lokality, u kterých lze očekávat vyšší odchylky již z toho důvodu, že mají celkově vyšší spotřebu. Nejvíce budou tedy penalizovány lokality s nejvyššími odchylkami mezi všemi lokalitami. Tomu lze předejít užitím kritéria

$$Err_3(l) = 100 \cdot \frac{\sum_{t \in \tau} |\hat{Y}_{tl} - Y_{tl}|}{\sum_{t \in \tau} Y_{tl}}, \quad (7)$$

které posuzuje průměrnou denní odchylku vzhledem k průměrné denní spotřebě v dané lokalitě. Toto kritérium pochopitelně naopak více penalizuje lokality malé, kde je nízký základ díky nízké spotřebě. Nejvíce jsou tedy penalizovány lokality s vysokými odchylkami v rámci časového průběhu dané lokality.

Vzhledem k tomu, že odhad modelem GAMMA má pochopitelně také svou chybu, která je neměřitelná a promítá se do odhadu ztrát, lze uvažovat také o kritériích, která alespoň částečně vliv této chyby potlačují. Například lze zvolit lokalitu λ minimalizující kritérium 7 a posléze užít kritérium

$$Err_4(l) = \frac{1}{|\tau|} \sum_{t \in \tau} |(\hat{Y}_{tl} - Y_{tl}) - (\hat{Y}_{t\lambda} - Y_{t\lambda})|, \quad (8)$$

resp. jeho relativní podobu

$$Err_5(l) = \frac{\sum_{t \in \tau} |(\hat{Y}_{tl} - Y_{tl}) - (\hat{Y}_{t\lambda} - Y_{t\lambda})|}{\sum_{t \in \tau} Y_{tl}}. \quad (9)$$

4.2. Vliv chyby modelu

K posouzení vlivu chyby modelu byly vedle využití výše popsaných kritérií (8) a (9) provedeny experimenty s různými verzemi modelu GAMMA. Kromě poslední provozní verze modelu GAMMA určené k odhadu nevyfakturovaného plynu v Západočeské plynárenské, a.s. (ze září 2009 – ozn. jako verze 2.4.0) byly testovány další verze (se stejnou strukturou, odlišné pouze volbami při optimalizaci parametrů), a to:

verze 2.4.1.0 – optimalizace standardním způsobem (s využitím dat ZČP),

verze 2.4.1.1 – optimalizace s využitím dat ze zákaznického kmene RWE GasNet,

verze 2.4.1.2 – regionální optimalizace parametrů.

Kritériem pro porovnání jednotlivých verzí je relativní chyba odhadu posledního odečtu všech zákazníků, tj.

$$\frac{\sum_i \hat{Y}_i}{\sum_i Y_i}, \quad (10)$$

kde

Y_i je poslední měřená spotřeba zákazníka i ,

\hat{Y}_i je odhad spotřeby zákazníka i modelem GAMMA za období odpovídající spotřebě Y_i .

Vypočtené hodnoty kritéria (10) pro jednotlivé testované verze jsou uvedeny v tabulce 1. Ukazuje se dílčí zlepšení v jednotlivých po sobě jdoucích verzích.

Tabulka 1: Porovnání testovaných verzí modelu GAMMA na kmenových datech podle kritéria (10).

Verze	2.4.0	2.4.1.0	2.4.1.1	2.4.1.2
Přesnost [%]	97,67	98,15	98,53	98,69

K otestování vlivu verze modelu na porovnání lokalit lze využít například kritérium (6), jehož hodnoty jsou uvedeny v tabulce 2. Ač pozorujeme drobné (ve srovnání s celkovou hodnotou) rozdíly v hodnotách kritéria (6), výsledné pořadí lokalit se nemění. Zdá se tedy, že vliv verze modelu bude přinejmenším v první fázi vyhodnocování zanedbatelný.

Tabulka 2: Porovnání testovaných verzí modelu GAMMA na dostupných uzavřených lokalitách - kritérium (6).

Lokalita	verze modelu			
	2.4.0	2.4.1.0	2.4.1.1	2.4.1.2
8	128,25	127,68	129,91	131,00
7	78,61	75,32	76,10	77,35
9	44,29	41,70	40,79	39,56
4	29,41	27,05	27,32	27,32
5	25,74	23,35	23,04	22,85
1	24,01	21,98	21,85	21,81
6	10,35	9,82	9,75	9,66
3	9,70	9,49	9,36	9,13
2	5,19	5,02	4,89	4,74

4.3. Vyhodnocení

Jak bylo ukázáno v předchozím odstavci, volba verze modelu má na vyhodnocení ztrát v jednotlivých lokalitách zanedbatelný vliv. Pro vyhodnocení dostupných

lokalit proto zvolíme jednu z dostupných verzí. S ohledem na nejlepší výsledky na kmenových datech použijeme regionální verzi modelu (2.4.1.2).

Porovnání podle kritéria (6) poskytuje tabulka 2. Kritérium (5) dává stejné uspořádání, proto je z úsporných důvodů vynecháno. Porovnání podle zbylých kritérií uvedených v odstavci 4.1 je uvedeno v tabulce 3.

Tabulka 3: Porovnání testovaných lokalit podle kritérií (7), (8) a (9).

L.	$Err_3(l)$	L.	$Err_4(l)$	L.	$Err_5(l)$
7	48,730	8	3435,258	2	95,322
8	28,115	7	1268,978	3	49,797
3	25,838	9	479,103	7	43,227
2	23,602	2	59,767	6	27,201
1	21,886	3	327,209	8	27,104
4	20,512	4	312,672	1	16,246
6	16,505	1	307,173	4	11,708
9	16,209	6	293,452	9	9,710
5	12,386	5	0,000	5	0,000

Při pohledu na pořadí podle prvních tří kritérií figurují v popředí (jakožto nejhorší) lokality 8 a 7. V lokalitě 8 je však pozorováno podezřelé chování vstupních hodnot, jak ukazuje obrázek 2. Zdá se, že cca od října 2008 do října 2009 vypadlo měření na jednom nebo více ze čtyř vstupních bodů do lokality. V této lokalitě je proto zapotřebí prověřit kvalitu vstupních měřidel. V lokalitě 7 lze pozorovat obdobný problém (obrázek vynechán z úsporných důvodů). Vynecháme-li tyto lokality, lze věnovat zvýšenou pozornost lokalitám 4 a 5 podle kritéria (6), případně 2 a 3 podle dalších kritérií. V současné době bylo na základě prezentovaných výsledků rozhodnuto o osazení lokalit 7 a 4 průběhovými měřeními ve všech vstupních i výstupních bodech a k revizi průběhového měření vstupu v lokalitě 8.

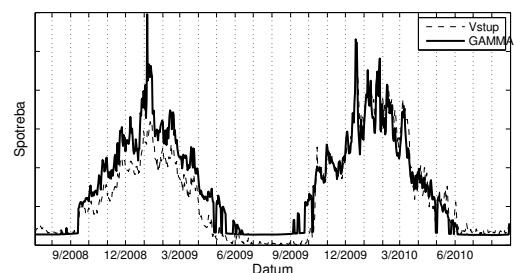

Obrázek 2: Porovnání časového průběhu vstupu a odhadu celkové spotřeby modelem GAMMA v lokalitě 8 za dostupné časové období.

5. Závěr

Byla uvedena problematika přepravy, měření a odhadu spotřeby zemního plynu ve světě a (zejména) v ČR. Dále byl prezentován projekt, v rámci něhož je ve spolupráci pracovních skupin ÚI AV ČR, v.v.i., a RWE GasNet, s.r.o., řešena problematika detekce zvýšených ztrát v uzavřených lokalitách.

Projekt je v počáteční fázi, kdy probíhá vývoj metodiky vyhodnocování odhadů ztrát. Jsou testována různá kritéria hodnocení ztrátových procesů a na základě nich vytipovávány lokality s největšími problémy. Ty mohou být způsobeny jak chybami v předávaných údajích (například výpadky měření na vstupu, chyby v průběhových měřeních spotřeb velkých zákazníků apod.), tak skutečnými zvýšenými ztrátami. Také pochopitelně mohou hrát roli další zatím nepředvídané vlivy.

Uvedení do praxe (rutinní zpracování stovek až tisíců uzavřených lokalit v rámci celé distribuční sítě) musí kromě masivního čištění zákaznické databáze předcházet ještě minimálně otestování na měřených údajích o ztrátách, což obnáší osazení vybraných lokalit průběhovými měřeními (všechny vstupy i odběrná místa). Tyto lokality budou vybrány na základě výsledků současné fáze projektu.

Poděkování

Autor studie děkuje svému školiteli Emilu Pelikánovi za revizi textu a cenné věcné i formální připomínky, dále pak celé řešitelské skupině projektu GAMMA.

Literatura

- [1] H. G. Berrisford, *The relation between gas demand and temperature: A study in statistical demand forecasting*. Operational Research Quarterly 16 (2), 229-246, 1965.
- [2] L. Blahová, J. Bečvář, M. Pihera, E. Pelikán a O. Konár, *Využití matematického modelování spotřeby zemního plynu*. Plyn: odborný měsíčník pro plynárenství 88 (10), 216-218, 2008.
- [3] M. Brabec, O. Konár, E. Pelikán a M. Malý, *A Nonlinear Mixed Effects Model for the Prediction of Natural Gas Consumption by Individual Customers*. International Journal of Forecasting 24 (4), 659-678, 2008.
- [4] M. Brabec, O. Konár, M. Malý, E. Pelikán a J. Vondráček, *A Statistical Model for Natural Gas Standardized Load Profiles*. Journal of the Royal Statistical Society Series C – Applied Statistics 58 (1), 123-139, 2009.
- [5] M. Brabec, M. Malý, E. Pelikán a O. Konár, *Statistical Model of Segment-Specific Relationship Between Natural Gas Consumption and Temperature in Daily and Hourly Resolution*. In *Natural Gas*. Rijeka: Sciyo, 393-416, 2010.
- [6] M. Brabec, M. Malý, E. Pelikán a O. Konár, *Consumption Model Calibration and Related Statistical Problems*. In *Applied Economics, Business and Development*. Athens: WSEAS Press, 141-146, 2009.
- [7] M. Brabec, M. Malý, E. Pelikán a O. Konár, *Statistical Calibration of the Natural Gas Consumption Model*. WSEAS Transactions on Systems 8 (7), 902-912, 2009.
- [8] J. Čermáková, J. Matějovic, O. Naxerová, J. Bečvář, M. Brabec, T. Brabec, O. Konár, M. Malý, E. Pelikán, M. Šimůnek a J. Vondráček, *Matematické modelování spotřeby zemního plynu zákazníků bez průběhového měření*. Plyn: odborný měsíčník pro plynárenství 85 (2), 34-37, 2005.
- [9] D. Ivezić, *Short-term natural gas consumption forecast*. FME Transactions 34, 165-169, 2006.
- [10] R. Fildes, A. Randall, and P. Stubbs, *One day ahead demand forecasting in the utility industries: Two case studies*. Journal of the Operational Research Society 48 (1), 15-24, 1997.
- [11] B. Geiger and M. Hellwig, *Gaslastprofile für nicht leistungsgemessene Kunden*. BWK – Das Energie Fachmagazin 55, 72-78, 2003.
- [12] S. Gil and J. Deferrari, *Generalized model of prediction of natural gas consumption*. Transactions of the ASME 126, 90-97, 2004.
- [13] O. Konár, *Matematické modelování spotřeby zemního plynu domácností a maloodběratelů*. In *Sborník ROBUST 2006*. Praha: JČMF, 151-158, 2006.
- [14] O. Konár, *Model spotřeby zemního plynu s náhodnými parametry*. In *Projekty GA AV ČR „Informační společnost“*. Praha: Ústav informatiky AV ČR. [Seminář projektů GA AV ČR Informační společnost 1ET400300513 a 1ET400300414, Beroun, 23.04.2007-24.04.2007, CZ].
- [15] O. Konár, *Nelineární model se smíšenými efekty pro odhad spotřeby zemního plynu*. In *Doktorandské dny 07*. Praha: Ústav informatiky AV ČR, v. v. i. & MATFYZPRESS, 2-7, 2007.
- [16] O. Konár, *Detekce zvýšených ztrát v distribuční síti zemního plynu*. In *ROBUST 2010*. Kniha abstraktů. Praha: JČMF, 22-22, 2010.
- [17] F. K. Lyness, *Gas demand forecasting*. Statistician 33, 9-21, 1984.

- [18] E. Pelikán, K. Eben, M. Šimůnek, M. Kolman a J. Hais, *Predikční systém Elvíra pro predikci spotřeby zemního plynu*. Plyn: odborný měsíčník pro plynárenství 80 (11), 253-255, 2000.
- [19] E. Pelikán, K. Eben a M. Šimůnek, *Predikce spotřeby elektrické energie a zemního plynu*. AUTOMA, odborný časopis pro automatizační techniku 7 (4), 15-18, 2001.
- [20] E. Pelikán, M. Brabec, M. Malý, O. Konár a J. Vondráček, *Zkušenosti se statistickým modelováním spotřeby zemního plynu*. In ROBUST 2008. Praha: JČMF, 315-341, 2009.
- [21] P. Potočník, M. Thaler, E. Govekar, I. Grabec, and A. Poredoš, *Forecasting risks of natural gas consumption in Slovenia*. Energy Policy 35, 4271-4282, 2007.
- [22] P. Potočník, E. Govekar, and I. Grabec, *Short-term natural gas consumption forecasting*. Proceedings of the 16th IASTED International Conference on Applied Simulation and Modelling, Palma de Mallorca, August 29-31, 2007 (A Publication of IASTED, 581). ACTA Press, Anaheim, 35-357, 2007.
- [23] E. F. Sánchez-Úbeda and A. Berzosa, *Modeling and forecasting industrial end-use natural gas consumption*. Energy Economics 29, 710-742, 2007.
- [24] J. Suykens, P. Lemmerling, W. Favoreel, B. De Moor, M. Crepel, and P. Briol, *Modelling the Belgian gas consumption using neural networks*. Neural Processing Letters 4, 157-166, 1996.
- [25] A. Svoboda a kol., *Plynárenská příručka – 150 let plynárenství v Čechách a na Moravě*. Praha: GAS s.r.o., 1997.
- [26] I. Vajk and J. Hetthéssy, *Load forecasting using nonlinear modelling*. Control Engineering Practice 13 (7), 895-902, 2005.
- [27] E. Valor, V. Meneu, and V. Caselles, *Daily Air Temperature and Electricity Load in Spain*. Journal of Applied Meteorology 40 (8), 1413 – 1421, 2001.
- [28] J. Vondráček, E. Pelikán, O. Konár, J. Čermáková, K. Eben, M. Malý a M. Brabec, *A Statistical Model for the Estimation of Natural Gas Consumption*. Applied Energy 85 (5), 362-370, 2008.
- [29] *Vyhláška č. 524/2006 Sb. o pravidlech pro organizování trhu s plynem a tvorbě, přiřazení a užití typových diagramů dodávek plynu (příloha 9) se změnami: 184/2007 Sb., 321/2007 Sb., 354/2008 Sb.*. Energetický regulační úřad, 2006-2008.
- [30] *Vyhláška č. 365/2009 Sb. o Pravidlech trhu s plynem*. Energetický regulační úřad, 2009.

Analysis of Algebraic Preconditioning Based on Different Variants of the Gram-Schmidt Algorithm

Post-Graduate Student:

ING. JIŘÍ KOPAL

Faculty of Mechatronics and Interdisciplinary Engineering Studies
Technical University of Liberec
Hálkova 6
461 17 Liberec 1, CZ

jiri.kopal@tul.cz

Supervisor:

PROF. ING. MIROSLAV TŮMA, CSC. ¹
DOC. DR. ING. MIROSLAV ROZLOŽNÍK ²

Institute of Computer Science of the ASCR, v. v. i.
Pod Vodárenskou věží 2
182 07 Prague 8, CZ

tuma@cs.cas.cz ¹, miro@cs.cas.cz ²

Field of Study:
Science Engineering

This work was supported by the international collaboration support M100300902 of AS CR and by the grant No. 102/08/H081 of the Grant Agency of the Czech Republic.

Abstract

This paper deals with an approximate inverse preconditioning and solving linear algebraic equation systems $Ax = b$ with symmetric and positive definite $n \times n$ matrix A having a sparse pattern. The preconditioning is based on incomplete decomposition using the Gram-Schmidt process with the non-standard inner product induced by the matrix A . The incompleteness is achieved through dropping entries which are small absolutely, or relatively with respect to other computed quantities. The main goal of the paper is to show a connection among dropping in the described incomplete decomposition, loss of A -orthogonality and convergence of the iterative solver which is the conjugate gradient method. The results for a real-world problem are accompanied by the derived bounds for the loss of A -orthogonality bounds.

1. Introduction

Solving systems of linear algebraic equations forms a crucial part of many problems of scientific computing. There are two basic solving approaches - using a direct or an iterative solver. By direct solver we mean a general class of approaches based on the Gaussian elimination. The direct solver may often change the matrix sparsity pattern and this can result in adding new nonzero entries, which are called fill-in. The amount of the fill-in and of the resulting memory requirements may be decreased by sophisticated reorderings of the original matrix, see, e.g., [12]. Direct solvers are typically very robust, they often provide rather accurate solution, but they may be expensive. Very often only a rough approximation of the solution is needed. This is the reason, why an itera-

tive solver may be a method of choice. The term iterative solver includes wide class of methods, which converge to the solution in some precisely defined sense (residual minimization, energy norm of error minimization, etc.). Some general iterative solvers converge to the solution in infinite number of steps, but there are several methods which converges in exact arithmetic in at most n -steps (eg. conjugate gradient (CG) method, generalized minimal residual (GMRES) method, etc.). As mentioned above, only a solution approximation can be hopefully obtained in a few iterations is often sought. The conjugate gradient method minimizes energy norm of error. It is probably the most frequently used iterative method for solving linear systems of equations with SPD matrices. We will focus on the linear systems, which arise from the finite element method. The matrix A and the right hand side b involve error, which may have the following main sources:

- Chosen partial differential equations do not describe given reality exactly,
- exact material parameters are not precisely known,
- error from model linearization,
- discretization error.

The sources of error induce perturbations ΔA and Δb , so that the solution of the perturbed system

$$(A + \Delta A)(x + \Delta x) = b + \Delta b \quad (1)$$

is $x + \Delta x$ where Δx can be often estimated based on the initial system perturbations. Consequently, it may not be necessary to find the exact solution of the linear system (1). Instead, a solution with small residual may be fine

and this can be easier to find. As a direct solver in general needs suitable matrix reordering and other technical enhancements, an iterative solver needs for a successful convergence apart from other tools a transformation called preconditioning. In our case and for SPD matrices we can see a preconditioner as an approximation of the inverse matrix, which improves its spectral properties. It is a well known fact, that the eigenvalues determine the CG convergence.

Section 2 presents an introduction to the preconditioning, simple overview of preconditioning techniques which then focuses to the generalized Gram-Schmidt. Section 3 is dedicated to the conjugate gradient method in general. Finally Section 4 contains some experimental results for a test problem. Section 5 concludes this contribution mentioning also the future work.

2. Preconditioning

As it was mentioned above, a preconditioner approximates the inverse of the matrix A . In practice we distinguish preconditioning from the left and from the right. Assume that P is a preconditioner. The preconditioning transformation of a given linear system $Ax = b$ from the left can be put down as follows

$$PAx = Pb. \quad (2)$$

Similarly, system preconditioned from the right can be written as

$$APy = b, \quad y = P^{-1}x. \quad (3)$$

In both cases this notation is just symbolic, since the real implementation may differ. Formally, for CG there is a problem because the products PA and AP do not preserve symmetry of the original matrix A and in order to preserve it we have to combine both approaches. If we assume the preconditioner in the factorized form $P = ZZ^T$ we get both-sided preconditioned linear system in the form

$$Z^T AZy = Z^T b, \quad y = Z^{-1}x \quad (4)$$

which may be obtained implicitly in the implementation. A successful preconditioner has to satisfy the two following requirements

- $\text{nnz}(Z)$ (number of nonzeros in Z) have to be small
- the norm $\|Z^T AZ - I\|$ have to be small for a given sparsity pattern of Z

The first assumption is connected to the internal computations in iterative methods. Small $\text{nnz}(A)$ and $\text{nnz}(Z)$

do not necessarily imply small $\text{nnz}(Z^T AZ)$, but since we may store these quantities implicitly, the fast matrix-vector multiplications (matvecs) repeatedly applied in iterative methods guarantee fast computation and small number of flops. The second assumption is connected to the spectral properties of the preconditioned matrix implying fast convergence of the iterative method.

2.1. Preconditioning techniques

There is a lot of ways to compute a simple preconditioner (see, e.g., [2]), which may also take into account parallel computing environment. Here we will deal with explicit preconditioners which approximate the inverse problem $P \equiv ZZ^T \approx A^{-1}$. An interesting example is the SPAI approach [4] which minimizes the functional $\|I - PA\|_F$ and may be reduced to decomposition to n much simpler problems. In addition, this approach is naturally parallel. For a general survey of preconditioning techniques see also [10]. Briefly, for SPD matrices we may use the incomplete Cholesky factorization (IC), see its explanation in [9], modified incomplete Cholesky factorization (MIC), incomplete Cholesky threshold (ICT) [1], approximate inverse (AINV) [3] and SAINV (stabilized AINV) [5] which are based on the generalized Gram-Schmidt process. AINV uses specific orthogonalization between classical and modified Gram-Schmidt process and SAINV uses modified Gram-Schmidt process. The last two algorithms will be described in this contribution. An important subclass of incomplete decompositions is based on prescribing more sophisticated pattern of the nonzero entries. This type of procedure provides level based preconditioners.

2.2. Generalized Gram-Schmidt based preconditioners

Generalized Gram-Schmidt algorithm assumes SPD matrix A and initial basis of the column vectors (linearly independent) - matrix $Z^{(0)}$, which will be A -orthogonalized against previously computed vectors. Algorithm produces matrices Z and U , where the matrix U is in an upper triangular form. In exact arithmetic the computed matrices satisfy the following identities

- $Z^T AZ = I$,
- $Z^{(0)} = ZU$,
- $(Z^{(0)})^T AZ^{(0)} = U^T U$.

It is clear that for an upper triangular $Z^{(0)}$ we get the matrix Z as the inverse upper triangular factor of A (unique). In addition for $Z^{(0)} = I$ we get matrix U as the Cholesky factor of the matrix A . The basic algorithm has a lot of variants eg.

classical - CGS/modified - MGS/AINV orthogonalization, right-looking/left-looking, with/without pivoting, with/without iterative refinement and their arbitrary combinations. For distinction with exact arithmetic counterparts, we denote quantities computed in finite precision arithmetic using an extra upper-bar. Main versions of the algorithms can be put down as follows

MGS algorithm

- (1) for $k = 1 : n$
- (2) for $j = 1 : k - 1$
- (3) $\bar{U}_{jk} := \langle \bar{z}_k^{(j-1)}, \bar{z}_j \rangle_A$
- (4) $\bar{z}_k^{(j)} := \bar{z}_k^{(j-1)} - \bar{U}_{jk} \bar{z}_j$
- (5) end for
- (6) $\bar{U}_{jj} := (\langle \bar{z}_k^{(k-1)}, \bar{z}_k^{(k-1)} \rangle_A)^{1/2}$
- (7) $\bar{z}_k := \bar{z}_k^{(k-1)} / \bar{U}_{jj}$
- (8) end for

AINV orthogonalization

- (1) for $k = 1 : n$
- (2) for $j = 1 : k - 1$
- (3) $\bar{U}_{jk} := \langle \bar{z}_k^{(j-1)}, z_j^{(0)} \rangle_A / \bar{U}_{jj}$
- (4) $\bar{z}_k^{(j)} := \bar{z}_k^{(j-1)} - \bar{U}_{jk} \bar{z}_j$
- (5) end for
- (6) $\bar{U}_{jj} := (\langle \bar{z}_k^{(k-1)}, z_k^{(0)} \rangle_A)^{1/2}$
- (7) $\bar{z}_k := \bar{z}_k / \bar{U}_{jj}$
- (8) end for

CGS algorithm

- (1) for $k = 1 : n$
- (2) for $j = 1 : k - 1$
- (3) $\bar{U}_{jk} := \langle z_k^{(0)}, \bar{z}_j \rangle_A$
- (4) endfor
- (5) for $j = 1 : k - 1$
- (6) $\bar{z}_k^{(j)} := \bar{z}_k^{(j-1)} - \bar{U}_{jk} \bar{z}_j$
- (7) end for
- (8) $\bar{U}_{jj} := (\langle \bar{z}_k^{(k-1)}, \bar{z}_k^{(k-1)} \rangle_A)^{1/2}$
- (9) $\bar{z}_k := \bar{z}_k / \bar{U}_{jj}$
- (10) end for

Notes:

In the third row can see a significant difference among the algorithms - each of them uses different vectors to compute the inner product. In exact arithmetic this leads to the same results. To compute the diagonal entries \bar{U}_{jj}

one can use several ways. Among all given algorithms MGS leads to the best results in finite precision arithmetic. For $Z^{(0)} = I$ inner product in AINV algorithm reduces to the Euclidean inner product (consequently orthogonalized vector $\bar{z}_i^{(j-1)}$ and row/column of the matrix A selected via e_j). CGS variant offers significantly better potential for parallel implementations. Initial vector basis $Z^{(0)}$ in the form $Z^{(0)} = I$ is the most preferred way for using this (incomplete) algorithms for computing preconditioners. In finite precision arithmetic CGS and AINV behave similarly (they have the same error bounds as we will show later). All these algorithms are breakdown free for well-conditioned problems. In addition all of them can be modified to the square root free versions if we do not scale vectors $\bar{z}_j^{(j-1)}$ and put $\bar{U}_{jj} = 1$.

A pioneering work in the analysis of the standard Gram-Schmidt algorithm can be found in [7] and in the recent work [6], but generalized Gram-Schmidt as an algorithm for computing preconditioner has not been analyzed yet. In [11] we provided the bounds for the described algorithms as follows:

CGS, AINV orthogonalization:

$$\|I - \bar{Z}^T A \bar{Z}\| \leq \frac{\mathcal{O}(n^{5/2})u\kappa(A)\kappa(A^{1/2}Z^{(0)})\kappa(Z^{(0)})}{1 - \mathcal{O}(n^{5/2})u\kappa(A)\kappa(A^{1/2}Z^{(0)})\kappa(Z^{(0)})}$$

MGS:

$$\|I - \bar{Z}^T A \bar{Z}\| \leq \frac{\mathcal{O}(n^{5/2})u\kappa(A)\kappa(A^{1/2}Z^{(0)})}{1 - \mathcal{O}(n^{5/2})u\kappa(A)\kappa(A^{1/2}Z^{(0)})},$$

where $\mathcal{O}(n)$ is a low degree polynomial in the problem dimension and u is the corresponding unit roundoff. For instance floating point double precision has $u \approx 1.1 \cdot 10^{-16}$. Quality of the computed symmetric preconditioner can be assessed via the norm $\|\bar{Z}^T A \bar{Z} - I\|$, which was already mentioned. This norm can be seen for Gram-Schmidt as the loss of A -orthogonality of the column vectors in the matrix \bar{Z} . Matrix \bar{Z} , which is computed by the complete algorithm does not fulfil condition of the small $\text{nnz}(\bar{Z})$. There is a way how to use the bounds in [11] and construct incomplete algorithms using on already analyzed full algorithms. Rounding error analysis is then based on the worst case which can occur in finite precision arithmetics. For instance for general atomic floating point operation - op and two numbers x and y in finite precision arithmetics we can write as follows [8]:

$$|\text{fl}[x \text{ op } y]| \leq |(x \text{ op } y)|(1 + u), \quad (5)$$

where $\text{fl}[\cdot]$ means computation in the finite precision arithmetics. This rule can be used to the algorithms on the

level of vector SAXPY updates (line 4 for MGS and AINV and line 6 for CGS). Assume an update of the vector $z_i^{(j-1)}$. For every component it holds

$$z_i^{(j)} = z_i^{(j-1)} - U_{ji}z_j + \delta_i^{(j)}, \quad (6)$$

where $\delta_i^{(j)}$ is the rounding error obtained from (5) as

$$\delta_i^{(j)} \leq u|z_i^{(j-1)}| + 2u|U_{ji}||z_j|. \quad (7)$$

Arithmetic with higher unit roundoff u_{new} can be simulated using the following generic rule:

$$\begin{aligned} (1) \quad & mask = |z_i^{(j)}| \geq u_{new}(|z_i^{(j-1)}| + 2|U_{ji}||z_j|) \\ (2) \quad & z_i^{(j)} = z_i^{(j)} \cdot *mask \end{aligned}$$

Note that *mask* represents a vector of the boolean values. It is componentwise set if the result ($z_i^{(j)}$) in double precision arithmetic is greater or equal than the simulated roundoff error. Second line shows dropping of components corresponding to components in *mask* which were not set. In this way we get the incomplete GS algorithms.

One can extend the previous dropping approach to computing inner products. For example, the roundoff error in computing inner product in the MGS variant is given by

$$\mathfrak{fl}[\langle z_k^{(j-1)}, z_j \rangle_A] \leq \langle z_k^{(j-1)}, z_j \rangle_A + \Delta U_{jk}, \quad (8)$$

where using (5) we get

$$\Delta U_{jk} \leq 2m^{3/2}u\|A\|\|z_k^{(j-1)}\|\|z_j\|. \quad (9)$$

For the other algorithms, dropping on the level of the orthogonalization coefficients can be done similarly.

Reasonable limit in the u_{new} , that we can use is given by the loss of orthogonality bounds. It is desirable to have the loss of A -orthogonality $\|Z^T AZ - I\| \leq 1$. For simplicity the numerator has to be < 1 and denominator > 0 . For our loss of orthogonality both bounds lead to the same conditions. Low degree polynomial $\mathcal{O}(m^{5/2})$ arise from the worst case roundoff, for low dimensional problems it behaves as $\mathcal{O}(m^{5/2}) \approx 1$, how we can see in [11]. Substitution $\mathcal{O}(m^{5/2})u$ by u_{new} and using assumption for the loss of A -orthogonality, one gets equation

$$u_{new}\kappa(A)^{3/2} < 1, \quad (10)$$

but this condition is very strict and does not provide a sparse preconditioner, as it will be shown later in text.

Summarizing previous lines, we introduced a dropping strategy having the same behavior as the derived bounds for rounding errors. Note that there exist a lot of dropping strategies for different preconditioners but most of them were not analyzed and it would be difficult to do so.

3. Conjugate gradient method

The conjugate gradient method (CG) is an iterative method based on the Lanczos process which belongs to the class Krylov subspace methods. The solution approximation x_k in the k -th step of the algorithm satisfies $x_k \in \mathcal{K}_k(A, r_0)$, where $\mathcal{K}_k(A, r_0)$ is the k -th Krylov subspace generated by the matrix A and by the initial residual r_0 . CG can be seen as a procedure to minimize the quadratic functional $f(x) = \frac{1}{2}x^T Ax - x^T b$ with the gradient g of this functional equal to $g = Ax - b$ (negative residual vector). The standard CG algorithm can be put down follows

$$\begin{aligned} (1) \quad & r_0 = b - Ax_0 \\ (2) \quad & p_0 = r_0 \\ (3) \quad & \text{for } k = 0 : n - 1 \\ (4) \quad & \alpha_k = \frac{p_k^T r_k}{p_k^T A p_k} \\ (5) \quad & x_{k+1} = x_k + \alpha_k p_k \\ (6) \quad & r_{k+1} = r_k - \alpha_k A p_k \\ (7) \quad & \beta_k = \frac{p_k^T A r_{k+1}}{p_k^T A p_k} \\ (8) \quad & p_{k+1} = r_{k+1} - \beta_k p_k \\ (9) \quad & \text{endfor} \end{aligned}$$

CG preconditioned from both sides (4) can be after some substitution written as follows:

$$\begin{aligned} (1) \quad & r_0 = b - Ax_0 \\ (2) \quad & p_0 = ZZ^T r_0 \\ (3) \quad & \text{for } k = 0 : n - 1 \\ (4) \quad & \alpha_k = \frac{p_k^T r_k}{p_k^T A p_k} \\ (5) \quad & x_{k+1} = x_k + \alpha_k p_k \\ (6) \quad & r_{k+1} = r_k - \alpha_k A p_k \\ (7) \quad & \beta_k = \frac{p_k^T A Z Z^T r_{k+1}}{p_k^T A p_k} \\ (8) \quad & p_{k+1} = Z Z^T r_{k+1} - \beta_k p_k \\ (9) \quad & \text{endfor} \end{aligned}$$

As mentioned above, if we do not compute the product $\bar{Z}^T A \bar{Z}$ explicitly, it is not necessary to have the preconditioner in the factorized form because $\bar{P} = \bar{Z} \bar{Z}^T \approx A^{-1}$. CG algorithm minimizes energy norm of the error, which is not known during the process. This fact does not enable a simple stopping criterion based on this va-

lue. Instead, stopping criteria are often based on the relative residual. Note that it can occur that the residual vector norm may locally grow.

4. Test problem

As a test problem we chose the matrix BCSSTK07 with dimension $n = 420$ from MatrixMarket [13]. Condition number of this matrix $\approx 1.2 \cdot 10^7$. In this section we will discuss convergence of CG preconditioned by AINV and SAINV with respect to the loss of A -orthogonality of the column vectors of the factorized preconditioner. As the matrix of initial columns vectors for all cases in this section we use $Z^{(0)} = I$. All presented results are computed by using dropping on the level of vector updates (not in orthogonalization coefficients).

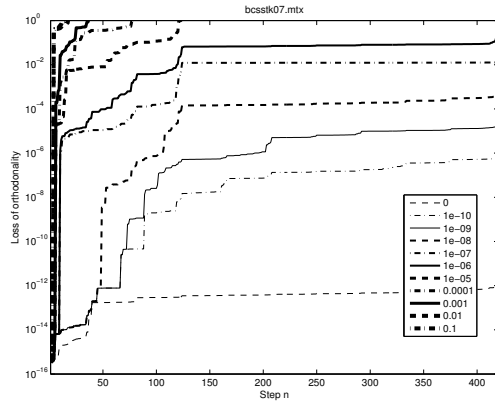

Figure 1: Loss of orthogonality for the AINV algorithm.

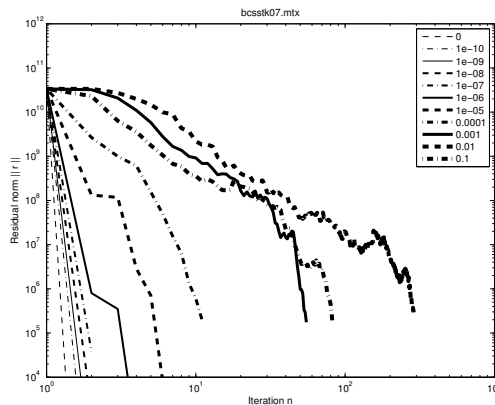

Figure 2: Convergence for CG preconditioned by AINV.

Convergence of CG is similar (Figures 2 and 4) until drop tolerance is equal to $1 \cdot 10^{-4}$. Differences can be found for the drop tolerances higher than $1 \cdot 10^{-6}$. In both cases the A -orthogonality is completely lost as we can see in the corresponding Figures (1) and (3).

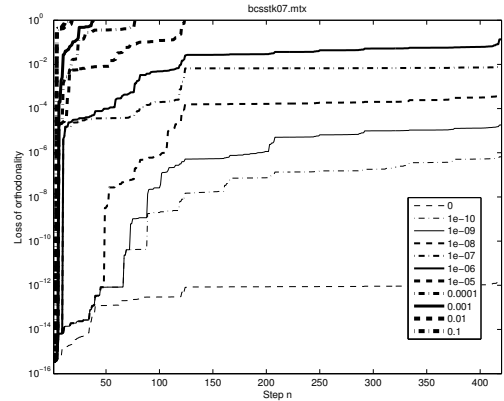

Figure 3: Loss of orthogonality for the SAINV algorithm.

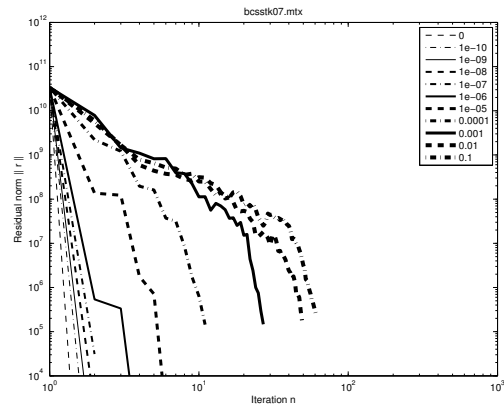

Figure 4: Convergence for CG preconditioned by SAINV.

Whereas SAINV converges for drop tolerance $1 \cdot 10^{-1}$ in about 50 steps, AINV needs about 200 steps for the corresponding $\text{nnz}(\bar{Z})$, see Table (1).

matrix bcsstk07		
u_{new}	AINV $\text{nnz}(\bar{Z})$	SAINV $\text{nnz}(\bar{Z})$
0.0	82722	82722
$1.0 \cdot 10^{-10}$	82648	82648
$1.0 \cdot 10^{-9}$	82646	82646
$1.0 \cdot 10^{-8}$	82626	82626
$1.0 \cdot 10^{-7}$	82513	82512
$1.0 \cdot 10^{-6}$	81773	81752
$1.0 \cdot 10^{-5}$	78573	78418
$1.0 \cdot 10^{-4}$	68843	68391
$1.0 \cdot 10^{-3}$	52730	44628
$1.0 \cdot 10^{-2}$	32173	16559
$1.0 \cdot 10^{-1}$	7924	5648

Table 1: Number of nonzeros in the factor \bar{Z} for given u_{new} computed by AINV and SAINV.

We get the matrix \bar{Z} by columns, so that in the i -th step we have the matrix \bar{Z}_i with i columns. For given drop tolerances we try to show how the eigenvalues of the matrix $\bar{Z}_i \bar{Z}_i^T$ evolves and converges to the eigenvalues of the matrix A^{-1} during the computational process. Finally we will show spectral properties of the matrix A^{-1} with comparison of the spectral properties of the computed matrix $\bar{Z} \bar{Z}^T$, which is computed using incomplete Gram-Schmidt algorithms.

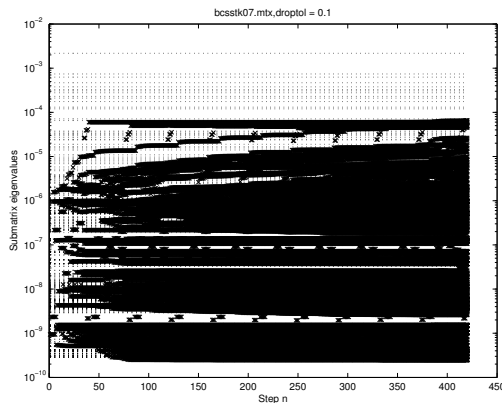

Figure 5: Evolution of the eigenvalues for the AINV algorithm.

Dotted horizontal lines show eigenvalues of the inverse operator A^{-1} , by x-marks are displayed eigenvalues of the matrices $\bar{Z}_i \bar{Z}_i^T$. Dropping causes cancelation of the smallest eigenvalues of the matrix A , therefore spectrum of the approximate inverse does not involve the largest eigenvalues when compared with the spectrum of the exact inverse as we can see in Figures (5) and (6). Although the spectra of the preconditioners seem to be similar, results of SAINV are much better and we currently do not know why.

References

[1] Y. Saad, "Iterative Methods for Sparse Linear Systems", *WPS*, 1996.
 [2] J.A. Meijerink and H.A. van der Vorst, "An Iterative Solution Method for Linear Systems of Which the Coefficient Matrix is a Symmetric M-Matrix", *Math.Comp.* 31,148, 1977.
 [3] M. Benzi, C.D. Meyer, and M. Tůma, "A sparse approximate inverse preconditioner for the conjugate gradient method", *SIAM J. Scientific Computing*,17, pp. 1135-1149, 1996.
 [4] T. Huckle, A. Kallischko, A. Roy, M. Sedláček,

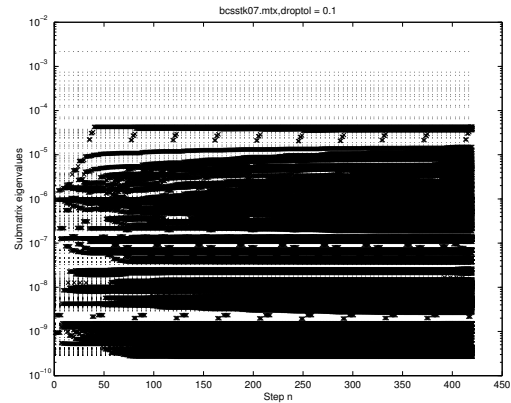

Figure 6: Evolution of the eigenvalues for the SAINV algorithm

5. Conclusion

In this paper we have summarized derived bounds for the generalized Gram-Schmidt algorithm analysis and proposed a new dropping strategy which is based on the problem analysis (local bounds) further, we tried to find a connection among loss of A -orthogonality, dropping and convergence of CG. As it was shown, the quality of the preconditioner is not given only by the loss of A -orthogonality because preconditioner computed by SAINV provides much better results than AINV also for the cases when A -orthogonality among column vectors in the factor \bar{Z} is completely lost, although having for similar $\text{nnz}(\bar{Z})$. Presented dropping strategy (dropping on the level of vector updates) does not allow controlling $\text{nnz}(\bar{Z})$ in the continuous way. This work has not been finished yet, it only shows the most recent result and outlines the future direction of our work.

and T. Weinzierl, "An efficient parallel implementation of the MSPAI preconditioner", *Parallel Computing*, 36(5-6): 273-284, 2010.

[5] M. Benzi and M. Tůma, "A robust incomplete factorization preconditioner for positive definite matrices", *Numerical linear algebra factorization with applications*, vol. 10, pp. 385-400, 2003.
 [6] L. Giraud, J. Langou, M. Rozložník, and J. van den Eshof, "Rounding error analysis of the classical Gram-Schmidt orthogonalization process", *Numerische Mathematik*, 101: 87-100, 2005.
 [7] Å. Björck, "Solving linear least squares problems by Gram-Schmidt orthogonalization", *BIT*, Vol. 7, pp. 1-21, 1967.

- [8] N.J. Higham, “Accuracy and Stability of Numerical Algorithms - Second Edition”, *SIAM*, 2002.
- [9] G.H. Golub and C.F. Van Loan, “Matrix Computations (3rd ed.)”, *Johns Hopkins*, 1996.
- [10] M. Benzi, “Preconditioning Techniques for Large Linear Systems: A Survey”, *Journal of Computational Physics*, vol. 182(2), pp. 418-477, 2002.
- [11] J. K., M. Rozložník, A. Smoktunowicz and M. Tůma, “Rounding error analysis of orthogonalization with a non-standard inner product”, submitted to *Numerische Mathematik*, 2010.
- [12] I.S. Duff, A.M. Erisman, and J.K. Reid, “Direct methods for sparse matrices” *Oxford University Press*, 2003.
- [13] www.math.nist.gov/MatrixMarket/index.html, web page.

Subprocess Heuristic for Partially Observable Markov Decision Processes

Post-Graduate Student:

MGR. PAVEL KRČ

Institute of Computer Science of the ASCR, v. v. i.
Pod Vodárenskou věží 2
182 07 Prague 8, CZ

krc@cs.cas.cz

Supervisor:

DOC. ING. EMIL PELIKÁN, CSC.

Institute of Computer Science of the ASCR, v. v. i.
Pod Vodárenskou věží 2
182 07 Prague 8, CZ

pelikan@cs.cas.cz

Field of Study:
Engineer Informatics in Transportation

Abstract

This presentation introduces an approximation heuristic suitable for solving a certain class of partially observable Markov decision processes (POMDPs) that has been developed by the author within his master's thesis. The POMDP framework is generic enough to represent any real world stochastic process, however, an exact solution is computationally tractable for only the simplest models. The presented heuristic is based on decomposing the process to non-disjoint subprocesses, each of which is significantly dependent on only a limited number of other subprocesses, thus reducing the superexponential nature of the generic problem at a cost of ignoring some weaker dependencies within the stochastic process. Although the original idea is applicable to many POMDP problems and solution algorithms, an example application and implementation is presented including some test results.

Objektivizace charakteristik integrace informačních systémů ve zdravotnictví

doktorand:

ING. DANIEL KRŠIČKA

Ústav informatiky AV ČR, v. v. i.
Pod Vodárenskou věží 2
182 07 Praha 8

dkrsicka@gmail.com

školitel:

ING. MILAN ŠÁREK, CSC.

Ústav informatiky AV ČR, v. v. i.
Pod Vodárenskou věží 2
182 07 Praha 8

sarek@euromise.cz

obor studia:
Biomedicínská informatika

Abstrakt

Cílem výzkumné práce je příprava deterministických optimalizačních metod pro řízení integrační architektury informačních systémů (IS) ve zdravotnictví. Přípravovaná metodika má poskytnout aparát ke strukturovanému vyhodnocení a porovnání dílčích návrhů integrace IS. Očekávaným přínosem je snížení celkových nákladů (*TCO - Total Cost of Ownership*) a zvýšení flexibility prostředí (*TTM - Time to Market*). Při aplikaci a kombinaci vzorů a osvědčených řešení musí architekt vždy vzít v úvahu informace o prostředí, ve kterém se integrace buduje. Právě objektivizace hodnocení prostředí by měla úkol zjednodušit a její příklad je předmětem tohoto článku.

1. Komunikace

Pro účely této práce definujeme 2 základní typy komunikace, které budou dále hlouběji strukturovány:

- *lokální komunikace* je definována jako řízená výměna dat mezi 2 programy spuštěnými na stejném HW.
- *síťová komunikace* je definována jako řízená výměna dat mezi 2 programy běžícími na různých strojích propojených pomocí počítačové sítě.

Motivací k prezentovanému výzkumu je i fakt, že lokální komunikace se v mnohém liší od komunikace přes síť. Toto prosté tvrzení má poměrně komplexní množinu příčin a důsledků. Jak bude ukázáno, zanedbáváním uvedeného tvrzení a jeho důsledků dochází k vytváření nevhodných integračních řešení. Některé technické standardy pro integraci přes síť byly vyvinuty evolucionálně ze standardů pro synchronní lokální komunikaci. Při extrapolaci těchto standardů do oblasti integrace přes síť

Lze téměř jistě říct, že návrh distribuovaného systému stejným způsobem jako lokálního bude mít katastrofální následky.

Přehled základních rozdílů mezi lokální a síťovou komunikací je uveden v tabulce 1. Nyní se podívejme na jednotlivé aspekty podrobněji:

Spolehlivost komunikační infrastruktury

Budeme-li uvažovat o spolehlivosti, měli bychom vzít v úvahu parametry jako stav HW, množství konkurence procesů v daném prostředí, topografickou vzdálenost mezi komunikujícími procesy apod. V lokálním prostředí se nejčastěji pohybujeme na úrovni jednoho operačního systému (OS) nebo middleware, případně na úrovni společného HW, na němž jsou pomocí virtualizační technologie definovány virtuální stroje. Zásadním faktem je existence společného HW. Spolehlivost HW je zde téměř binární (stroj buď běží nebo ne, případné chyby se sdílí), na rozdíl od síťového spojení, kde za prvé procesy běží odděleně a za druhé na komunikaci se podílí řada dalších aktivních prvků. Detekce chybových stavů a alerting je řádově jednodušší lokálně než v síti. Také množství konkurenčně běžících procesů je typicky menší než při komunikaci přes obecně sdílenou síťovou infrastrukturu.

Rychlost komunikace

V lokálním prostředí také prakticky zanedbáváme vzdálenost komunikujících procesů, protože sdílejí stejný HW a jejich komunikace je omezena šířkou a taktem sběrnice. U dnešního hardware se pohybujeme v řádech desítek a stovek Gbps. Naopak při síťové komunikaci se v reálných hodnotách pohybujeme o řády níže, nejčastěji ve stovkách kbps, maximálně v jednotkách Mbps. Mluvíme zde o reálné komunikaci mezi procesy

na aplikační vrstvě (tzv. End-to-End), nikoli o rychlosti přenosových sítí, které mohou být mnohem vyšší.

Technologická diverzita

V návrzích integrace mezi systémy je potřeba počítat s rozdílností operačních systémů, použitých programovacích jazyků, middleware platform, kódování nebo obecně formátů dat. U síťových řešení je třeba se na všechny uvedené potenciální problémy připravit. Dnes existuje řada platformově nezávislých standardů založených na jazyce XML [10], jejich využití však má svá omezení. Jednak nejsou implementovány ve všech technologiích a dále pak nemusí být použitelné ve všech případech, především z výkonnostních důvodů.

Rozdílný režim správy

Se týká především organizačního zajištění integrovaných systémů a integrační technologie (včetně sítě). Je zřejmé, že 2 libovolné IS integrované přes síť mohou patřit a často patří rozdílným společnostem. Různé společnosti se vyznačují různou mírou penetrace ICT do jejich prostředí, včetně rozdílného množství organizačních procesů, které IT podporuje. Tato míra spolu s velikostí společnosti indikuje 2 druhy rozdílů v IT.

Za prvé je to využití odlišných technologií. Např. samostatně pracující praktický lékař si jistě nebude kupovat 64-jádrový server vyžadující 2kW chlazení a optický spoj s WDM. Naopak velká fakultní nemocnice si z nemůže dovolit budovat svou serverovou infrastrukturu na stolních PC, ani pro přístup do sítě používat ASDL nebo 802.11g spojení. Rozdílná úroveň používaných technologií pak implikuje i odlišné možnosti v propojení společnosti s externími subjekty. Tak vzniká riziko, že se nepodaří nalézt způsob vyhovující oběma stranám.

Za druhé existuje odlišnost v režimu správy resp. personálním zajištění. Větší společnosti mají obecně vyšší dostupnost své ICT infrastruktury a také mohou vykazovat lepší kvalitu svých ICT služeb. Naopak flexibilita při změnách bývá u větších společností výrazně menší.

Tato práce není zaměřena na organizační zajištění provozu a rozvoje integrovaných systémů. Více informací o problematice řízená architektury lze nalézt např. v [2].

2. Způsoby integrace

Dnes rozlišujeme 4 základní koncepty integrace [1], které se s různou úspěšností vyrovnávají s výše uvedenými aspekty integrace:

Batch File Transfer (BFT)

Dávková výměna souborů je nejjednodušším způsobem komunikace dat. Zdrojový systém vytvoří soubor obsahující řídicí příkazy resp. data a uloží ho na persistentní úložiště (např. diskové pole). Soubor je interaktivně nebo automaticky přenesen k cílovému systému, kde ho cílový systém načte. Samozřejmě lze realizovat jedno- i obousměrnou komunikaci. Kromě obsahu dat je nutné dohodnout a respektovat řadu obslužných parametrů jako jména souborů, čas výměny, umístění, mazání souborů i mechanismy obsluhy chybových stavů.

Shared Database (SDB)

Reprezentuje archetyp dvou a více systémů sdílejících v reálném čase jedno datové úložiště. V praxi se jedná nejčastěji o společnou databázi (DB), ale stejně tak lze za příslušných podmínek využít paměť nebo diskový prostor. Nemusí se jednat o integraci s výměnou dat, protože integrované systémy sdílí fyzicky jedno úložiště.

Remote Procedure Call (RPC)

Představuje model, ve kterém jeden systém nabízí určitou svou funkci přes síťové rozhraní a jiný systém ji volá. Vznikl evolucí lokálního volání procedur / funkcí v rámci jednoho stroje resp. systému na volání v rámci počítačové sítě. Extrapoluje koncept synchronní blokující operace z prostředí jednoho počítače na infrastrukturu separátních strojů propojených v síti a přináší problémy uvedené v úvodu tohoto článku. Jedná se o synchronní blokující komunikaci v reálném čase.

Messaging (MS)

Využívá dedikovaného software k doručování zpráv. Odesílatel předává zprávu MS a sám může pokračovat ve své další činnosti. MS je zodpovědný za doručení zprávy. Tato komunikace je asynchronní a neblokující. Koncept asynchronní komunikace vznikl právě v reakci na nemožnost přistupovat k systémům propojeným sítí stejně jako k systémům lokálním. Bohužel, dodnes není na mnoha místech všeobecně přijat do praxe. Při nárůstu objemu a počtu komunikací nad udržitelnou mez není již vhodné programovat messaging ručně. Dnes se k uvedenému účelu používá téměř výhradně některý z produktů kategorie Message Oriented Middleware (MOM) [1]. MOM pak tvoří transportní základ v modelu Enterprise Service Bus (ESB) [5]. Rozbor ESB je mimo rozsah možností tohoto článku.

Uvedené 4 způsoby nelze brát jako různé evoluční úrovně. Mezi zmíněnými kategoriemi neexistuje žádné uspořádání, které by vypovídalo o kvalitě toho kterého

způsobu samo o sobě. Základní určení způsobu integrace (ještě bez vazby na jakékoli další vzory či ověřené postupy) musí být dáno vždy aktuálními podmínkami tj. jednak vyspělostí ICT infrastruktury integrovaných společností a dále především požadavky na konkrétní výměnu dat. Generalizace na jeden způsob je vhodná jen od určité úrovně komplexnosti a nikdy nemůže být úplná (tj. dogmaticky uplatňovaná).

2.1. Časový rozměr komunikace

Zásadní informací u výše uvedených základních způsobu integrace je určení, zda je komunikace synchronní nebo asynchronní (viz tabulku 2). Magnam partem se zajímáme o integraci systémů přes počítačovou síť. Dokonalé rozdělení není možné, protože komunikace probíhá na více vrstvách. Některé používají blokující operace a jsou tedy synchronní, některé ne. Rozdělení je tedy nutné stanovit dohodou vycházející z následujících předpokladů:

- Dělení na blokující a neblokující operace definujeme na aplikační vrstvě tj. na vrstvě volajícího a přijímajícího procesu¹.
- Předpokládáme, že subsystémy realizující nižší vrstvy umožňují minimálně kvazi-paralelní zpracování více požadavků. Tzn., že žádný aplikační proces není na významně dlouhou dobu odstaven od prostředků.

Všechny uvedené způsoby lze využít k získávání informací on-demand (request/response) i k proaktivní publikaci informací (one-way). Způsob integrace tedy neimplikuje směr komunikace ani typ vyměňovaných informací.

3. Vzdálenost integrovaných systémů

Abychom mohli v analýze integračního scénáře zohlednit topografické rozdělení jednotlivých IS, je nezbytné zavést pojem vzdálenosti mezi integrovanými systémy. Vzdálenost musí být ordinální veličina s ostrým úplným uspořádáním, tj. na oboru hodnot musí být definována binární antireflexní, tranzitivní, antisymetrická relace uspořádání [16]. Pro objektivní hodnocení je také třeba definovat všechny hodnoty tak, aby bylo možné jednotlivé scénáře mezi sebou porovnávat. Pro účely této práce navrhuje následující kategorie $A - F$:

A Komunikace mezi procesy jednoho OS pomocí sdílené paměti (shared memory).

¹Je třeba dodat, že je možné a často vhodné realizovat synchronní scénář typu požadavek/odpověď pomocí MOM. Messaging implikuje asynchronní mechanismy na vrstvách nižších než je aplikační

B Komunikace mezi procesy jednoho OS pomocí lokálního síťového rozhraní (loopback) resp. mezi 2 virtuálními stroji na stejném HW (virtual network).

C Komunikace v LAN/SAN na přepínané síti včetně L3+ switchingu tj. řadíme sem komunikaci sítí, ve které jsou pouze aktivní prvky s výpočtem nad asociativní paměti (CAM).

D Komunikace v LAN/SAN na směrované síti tj. přes aktivní prvky pracující s CPU výpočtem. Pro zařazení do této kategorie je významná inspekce paketů tj. řadíme sem i firewally a IPS systémy kontrolující hlavičky protokolů vyšších vrstev.

E Komunikace dedikovanou (pronajatou) WAN – nad rámec uvedeného v kategorii D přibývá transportní zpoždění na síti, omezení pásma a prodleva konverze protokolů.

F Komunikace přes Internet tj. WAN spojený bez záruky dostupnosti a bez možnosti aplikace QoS.

Každá z uvedených skupin je charakterizována odlišným přenosovým pásmem, dostupným pro komunikující procesy. Například komunikace 2 aplikací přes sdílenou operační paměť jistě poběží rychleji než při komunikaci v rámci počítačové sítě společnosti, nebo dokonce při volání Internetem třeba z České Republiky do Austrálie.

Výše uvedené kategorie lze hrubě charakterizovat minimálně 3 atributy: dostupným přenosovým pásmem f , transportním zpožděním na síti t a mírou vyjadřující počet paralelních/kolidujících přenosů na síti a . Na úrovni představovaného modelu neuvažujeme o kolizních přenosech ve smyslu sdílení jednoho lokálního síťového pásma, ale jako o pravděpodobnosti, že v daném časovém úseku nebude přenos dat nijak výrazně narušen využitím stejné přenosové infrastruktury jiným komunikačním procesem. Infrastrukturu je zde celá komunikační cesta ve všech svých vrstvách a v celé své délce. Ze stejného důvodu nelze definovat transportní zpoždění jako veličinu nepřímo úměrnou dostupnému pásmu, protože, především u komunikací s „delší cestou“ tj. s přenosem přes rozsáhlé sítě, je linearita relace mezi pásmem a latencí narušena využitím řady aktivních prvků.

Přenosové pásmo f lze vyjádřit v různých jednotkách, pro naše účely volíme Hz a zanedbáváme

tak rozdílná přenosová kódování. Naopak níže uvedené hodnoty frekvencí jsou vždy vztaženy k šířce dostupné sběrnice (např. násobení základní frekvence bitovou šířkou sběrnice u lokální komunikace apod.). Transportní zpoždění t je druhým parametrem, vyjádřeným v sekundách. Představuje latenci mezi odesláním zprávy odesílatelem (aplikací/systémem) a jejím přijetím na aplikační vrstvě u příjemce. Jedná se tedy o čas zpoždění mezi 2 procesy. Posledním parametrem je míra dostupnosti přenosového pásma a , který souvisí se spolehlivostí komunikační infrastruktury diskutované v úvodu tohoto článku.

3.1. Výpočet vzdálenosti

Shora uvedeným veličinám jsme přiřadili hodnoty. Řádové pásmo f a zpoždění t bylo stanoveno na základě parametrů dnes používaných technologií. Míru dostupnosti a stanovíme dohodou jako reálné číslo z intervalu $\langle 0; 1 \rangle$, kde hodnota 1 vyjadřuje 100%-ní rezervaci pásma. Vzdálenost d mezi integrovanými systémy lze tedy vypočítat jako 1:

$$d = \log \left[\frac{\frac{1}{f} + t}{a} \right] \quad (1)$$

Pro výpočet použijeme převrácenou hodnotu f tak, abychom s narůstající šířkou přenosového pásma klesala hodnota vzdálenosti. Naopak transportní zpoždění t připočítáváme v lineárním smyslu. Mírou dostupnosti a výsledný výraz dělíme kvůli oboru hodnot, který je pro a definován $\langle 0; 1 \rangle$.

Po provedení výpočtů pro skutečné hodnoty frekvencí a latence výrazu $\frac{1}{f} + t$ získáváme hodnoty, které se v krajních případech vzájemně liší o 8 řádů. Další počítání s takovými hodnotami je nepraktické, proto je vhodné provést transformaci pomocí logaritmu.²

3.2. Normalizace vzdálenosti

Pro praktické užití by bylo vhodné reálná čísla, která jsou výsledkem výpočtu vzdálenosti, transformovat na určitou normalizovanou stupnici. Provedeme normalizaci vzdálenosti do intervalu $\langle 0; 1 \rangle$. Pro provedení normalizace musíme určit mezní hodnoty vypočtené vzdálenosti odpovídající teoretické hodnotě 0 resp. 1. Hodnoty mezního výpočtu jsou uvedeny v 3.

Výsledná normalizace se pak provede transpozicí do $R^+ + \{0\}$ a jeho projekcí na interval $\langle 0; 1 \rangle$. Normali-

²Byla testována i varianta s logaritmem odmocniny výrazu, nicméně výsledky se vzájemně v řádech příliš neliší a je inhibována informace o proporcii mezi jednotlivými kategoriemi. Proporcionalita hodnot může být důležitá v uplatnění veličiny vzdálenosti, a proto byla zvolena varianta výpočtu bez použití odmocniny.

zace tedy obecně vypadá následovně 2:

$$d_{norm} = \frac{d + |d_{min}|}{|d_{min}| + |d_{max}|} \quad (2)$$

Pak všechny hodnoty d_{norm} pro vstupy určené kategoriemi A - F 3 padnou do intervalu $\langle 0; 1 \rangle$ a pro mezní hodnoty platí $d_{norm}^{min} = 0$ a $d_{norm}^{max} = 1$.

3.3. Určení hodnot pro různá prostředí

Následuje výpočet normalizované vzdálenosti pro jednotlivé kategorie vzdáleností. Protože ICT infrastruktura se liší subjekt od subjektu v závislosti na jeho velikosti, počtu procesů podporovaných IT, počtu uživatelů, množství spravovaných dat, počtu integrovaných partnerů, míře legislativní regulace, geografické lokaci a dalších parametrech. Proto jsme příklad výpočtu rozdělili na 3 samostatné jednotky. Každá jednotka charakterizuje společnost o specifické velikosti.

SOHO (Small Office Home Office)

Malé subjekty, s jednotkami až desítkami uživatelů. Příkladem mohou být ambulance praktických lékařů, lékárny apod. Předpokládá se využití low-end zařízení pro síťovou komunikaci, plochá struktura místní sítě, běžné širokopásmové připojení do Internetu. Neočekáváme pronájem WAN spojů, ani dedikované serverové infrastruktury se speciálním serverovým HW. Ohodnocení vstupních veličin i vypočtené normované vzdálenosti lze nalézt v tabulce 4.

Mainstream

Společnosti střední velikosti s desítkami až stovkami zaměstnanců. Může se jednat o místní nemocnice, polikliniky, drobné výzkumné ústavy, menší pojišťovny, zdravotnické registry. V mainstreamu předpokládáme centralizaci dedikovaných serverů do výpočetních sálů, hierarchizaci přepínaných sítí, možnou existenci pronajatých linek s partnerskými společnostmi. Je možný výskyt systémů IPS a aplikačních firewallů. Ohodnocení vstupních veličin i vypočtené normované vzdálenosti lze nalézt v tabulce 5.

Enterprise

Velké společnosti. Stovky až tisíce uživatelů – fakultní nemocnice, centrální registry, velké pojišťovny, orgány státní správy etc. Očekáváme high-end výpočetní prostředky, specializované SAN sítě, optické spoje, de-

dikované linky pro spojení s detašovanými lokalitami. Ohodnocení vstupních veličin i vypočtené normované vzdálenosti lze nalézt v tabulce 6.

3.4. Využití normované vzdálenosti

Normovaná vzdálenost závisí na deterministických vstupech (pásmo, latence, dohodnutá míra dostupnosti). Výpočet i normalizaci zachovává proporce mezi jednotlivými kategoriemi, a proto by mělo být možné využít nejen uspořádání kategorií, ale i přímo hodnoty vzdálenosti při dalších výpočtech. Díky stanovení intervalu hodnot (oboru hodnot funkce vzdálenosti) je možné vzdálenost využít i pro případy, kdy se integrují 2 společnosti různé úrovně vyspělosti. Konečná normalizace nemá vliv na výpočty se vzdáleností, pouze usnadňuje jejich provedení a zlepšuje čitelnost.

4. Vazby mezi integrovanými systémy

Druhou vlastností integračních řešení analyzovanou v tomto článku je vazba mezi koncovými komunikujícími aplikacemi. Zatímco vzdálenost je příkladem charakteristiky prostředí v němž se integruje, vazbu formují samotné integrované systémy. Interaplikační vazba může být popsána sadou vlastností / atributů. Charakteristika vazby je důležitá pro objektivizaci popisu integračního scénáře, protože různé systémy mohou navazovat diametrálně odlišné vazby a to nejen na základě způsobu jejich propojení nebo vzdálenosti (viz výše). Z hlediska vazby nás zajímá míra závislosti mezi integrovanými systémy. Právě míra závislosti může být vyjádřena množstvím a vlastnostmi vazeb mezi komunikujícími IS.

V softwarovém inženýrství se nejčastěji používá klasifikace označující volnou vazbu (Loose Coupling) a těsnou vazbu (Tight Coupling). Taková klasifikace je pro formální objektivizaci nedostatečná, a proto je nutné klasifikaci dále propracovat. Základ klasifikačního modelu lze převzít z metod pro optimalizaci návrhu programového kódu [3]. Problematika architektury integračních řešení vykazuje celou řadu společných znaků, a proto můžeme základ klasifikace vazby mezi komponentami komunikujícími přes počítačovou síť postavit na modelu určeného pro programování na jednom počítači. Tento model je však nezbytně nutné dále rozpracovat, abychom zabránili automatické extrapolaci vlastností lokální komunikace na komunikaci v síti, jak bylo uvedeno dříve [1]. Vyjdeme-li z existujícího modelu, můžeme definovat následující kategorie vazeb. Ke každé kategorii uvádíme pro srovnání vždy příklad lokálního kódu i integračního řešení:

Content Coupling (silná těsná vazba)

Volaná komponenta nabízí svou funkcionalitu přímo, tj. volající iniciuje přímo výkonný kód volaného. Volající musí znát přesně strukturu, ve které volaný volání přijímá. *Příkladem je volání silně typované funkce v imperativním programovacím jazyce (např. v C) nebo volání funkce přes socket, tedy situace, kdy není využit žádný vyšší protokol nad TCP a zasílaná data přijímající program přímo interpretuje a to vždy stejně (data neobsahují řídicí znaky).*

Common Coupling (sdílení úložiště dat)

Představuje archetyp, v kterém 2 a více systémů sdílejí stejná data. Lze uvažovat na lokální úrovni (paměť), i na úrovni sítě (společná DB). Určujícím faktorem je i nutnost znát přesně datový model a schéma řízení přístupu. Informace drží a implementuje každý integrující systém. *Příkladem může být lokální volání funkce a předání parametru odkazem (pointer), nebo vytvoření sdíleného segmentu paměti (mezi 2 procesy OS), nebo třeba sdílení jedné databáze dvěma a více aplikacemi.*

External Coupling (externalizovaná společná vazba)

Předchozí typ lze upravit exportem informací o syntaxi na společné úložiště. Export obsahuje jak datové tak řídicí schéma. *Samostatně se dnes prakticky nepoužívá, ale je nedílnou součástí masivně rozšířených případů externalizace schémat webových služeb (XSD), WS-Standardů (policies etc.), nebo třeba kaskádových stylů webových aplikací (CSS). Lze však externalizovat i jiné informace, např. o místu přístupu k datům (tsnames.ora pro Oracle DB apod.). Je tedy třeba uvažovat o jednotlivých vrstvách ISO/OSI.*

Control Coupling (vazba s řízením)

Kategorie, kde volající komponenta přikládá k datovému obsahu zprávy řídicí příznak (příkaz), tj. informuje volaného, jak s daty naložit. Volající tedy nemusí znát všechny funkce volaného a s touto množinou lze dynamicky pracovat. *Příkladem je jakákoli funkce, obsahující řídicí argument. Lze vytvořit na úrovni kódu programovacího jazyka, ale stejně tak se využívá i v moderních WS-Standardech – např. hlavička `<SoapAction... />`*

Stamp Coupling (volnost datového schématu)

Je analogií předchozího případu, ale v oblasti dat. Volající nemusí nutně zaslat všechny datové atributy, ale jen některé a volající data dokáže zpracovat (pokud to sémantika případu dovoluje). *Webové služby založené na standardu SOAP [14] umožňují definovat povinné a*

nepovinné parametry stejně jako dynamicky jejich multiplicitu v dané zprávě. Využití principu Stamp Coupling predisponuje bezpečnostní slabiny systému a celkově zvyšuje nároky na robustnost výkonného kódu.

Message Coupling

Komunikace probíhá přes prostředníka, který uvolňuje vzájemné závislosti mezi komunikujícími systémy. Zde se nejedná o komunikaci messagingem tj. technologií pro asynchronní persistentní komunikaci, ale o prvek typu ESB [14]. Můžeme nalézt více úrovní vyspělosti vazby Message Coupling, jejich rozbor je však předmětem výzkumné práce a je mimo rozsah tohoto článku. *Mezi lokálními programy lze využít předání přes sdílenou paměť s intervencí OS (např. pipelines na *nixu). V síťové integraci jsou příkladem jednak komerční produkty IBM WMQ, případně produkty s vyšší logikou jako IBM WESB, SAP-PI, MS Biztalk, BEA WebLogic ..., ale i ESB řešení určená pro oblast zdravotnictví [4].*

4.1. Ordinální vyjádření vazby mezi IS

Stejně jako u vzdálenosti bude vhodné pro veličiny charakterizující vazbu mezi systémy definovat relaci ostrého uspořádání. Jeho úplnost je důležitým předmětem dalšího výzkumu. Předpokládáme ovšem, že bude nutné ustoupit od úplnosti a možná i od ostrosti uspořádání množiny definující kvalitu vazby. Tj. předpokládáme, že vazba mezi systémy nebude charakterizovatelná jedinou ordinální veličinou, ale minimálně dvěma. Důvodem je vzájemná kontradikce požadavků na volnost vazby a požadavků na výkonnost celého řešení. Cílem tedy bude nalezení optimálního vyvážení těchto důležitých metrik.

Zde uvádíme možné vyhodnocení míry závislosti mezi komunikujícími systémy pomocí množství vstupně/výstupních řídicích a datových parametrů. Základ číselné reprezentace míry závislosti (síly vazby) mezi systémy lze založit na [3].

$$c^{plain} = 1 - \frac{1}{D_i + 2 \cdot C_i + D_o + 2 \cdot C_o} \quad (3)$$

kde D_i , C_i jsou počty datových resp. řídicích vstupních proměnných (parametrů volání) a D_o , C_o jsou počty datových resp. řídicích výstupních proměnných (parametrů odpovědi).

Je zřejmé, že uvedenou číselnou reprezentaci lze velmi jednoduše ovlivnit změnou počtu datových i řídicích parametrů. Uvedený historický model určený pro vyhodnocení vazby mezi 2 lokálně běžícími programy tedy nelze použít v jeho originální podobě a musí být upraven. Shrňme nejzávažnější nedostatky:

- Pokud komunikující systémy neznají vzájemně svou vnitřní strukturu, mluvíme o volné vazbě. Teoreticky by bylo možné snížit počty datových parametrů na 1 resp. 2 (in/out) a řídicích na 0 a dosáhnout tak vazby $c = 0,5$. Budování takových rozhraní je však kontraproduktivní. Volná vazba znamená i možnost změn v rozhraních bez nutnosti změn mezilehlých a především protilehlých komponent. To nelze provést u nestrukturovaného rozhraní.
- V závislosti na míře vyspělosti je u menších řešení (SOHO/Mainstream) vhodné budovat integrace s přímým řízením, kde komunikující strany přímo ovládají zpracování dat a naopak u výše zmíněné kategorie Enterprise dedikovat logiku zpracování na ESB [5]. A i dále je možné řídicí atributy dělit na ty zpracované ESB a ty, které nesou informaci o sémantice dekódovatelné až konečným příjemcem.
- Řídicí informace mohou být poskytnuty v různé kvalitě v závislosti na míře jejich standardizace. U integračního řešení postaveného na obecně platných standardech [8] je zaručeně vyšší pravděpodobnost jeho opakovatelného využití a robustnosti v čase, než u těch budovaných na lokálních kódováních, číselnících, signalizaci apod. Uvedené tvrzení lze chápat na všech vrstvách od transportních protokolů, přes řídicí informace pro komunikující služby [13] až po standardizaci na aplikační úrovni [9].
- Komunikace mezi systémy může z hlediska aplikační logiky rozložena do více kroků. Nejtriviálnějším případem je komunikace požadavek/odpověď, další varianty pak znamenají již plnou statefull komunikaci s nutností udržování informací o relaci (session). Informace o počtu stavů musí být ve vyhodnocení volnosti vazby také zahrnuta.

Na základě uvedených informací upravíme algoritmus pro výpočet volnosti vazby o další aktivující i inhibující členy.

Především zavedeme *míru externalizace integračních funkcí* jako ordinální diskrétní veličinu vyjadřující mohutnost ESB. Definiční obor i navrhované hodnoty jsou uvedeny v tabulce 7. Prerekvizitou zařazení konkrétního prostředí k dané úrovni je splnění všech vlastností úrovní nižších, což někdy nemusí být automatické, především při využití orchestrace [6] procesů pomocí Business Process Engine [7].

<i>aspekt</i>	<i>lokální komunikace</i>	<i>síťová komunikace</i>
spolehlivost komunikační infrastruktury	vysoká	nízká
rychlost komunikace	vysoká	nízká
technologická diverzita	nízká	vysoká
rozdílný režim správy	nízké riziko	vysoké riziko

Tabulka 1: Aspekty síťové komunikace

	<i>synchronní</i>	<i>asynchronní</i>
komunikace v reálném čase	SDB, RPC, MS	MS
dávková komunikace off-line	-	BFT

Tabulka 2: Relace způsobu komunikace a jeho provádění v čase

<i>mezí hodnota vzdálenosti</i>	<i>pásmo [Hz]</i>	<i>latence [s]</i>	<i>míra dostupnosti pásma</i>	<i>vzdálenost</i>
d^{min}	10^3	10	10^{-4}	-8,995
d^{max}	10^{12}	10^{-9}	0,99	5,000

Tabulka 3: Mezní hodnoty vzdálenosti

<i>případ</i>	<i>pásmo [Hz]</i>	<i>latence [s]</i>	<i>míra dostupnosti pásma</i>	<i>vzdálenost</i>	<i>normovaná vzdálenost</i>
A	10^{10}	10^{-7}	0,9	-6,954	0,146
B	10^9	10^{-5}	0,7	-4,845	0,297
C	10^8	10^{-4}	0,1	-3,000	0,428
D	10^7	10^{-2}	0,1	-1,000	0,571
E	n/a	n/a	n/a	n/a	n/a
F	10^6	1	0,0001	4,000	0,929

Tabulka 4: Vypočtené hodnoty normované vzdálenosti pro kategorii SOHO

<i>případ</i>	<i>pásmo [Hz]</i>	<i>latence [s]</i>	<i>míra dostupnosti pásma</i>	<i>vzdálenost</i>	<i>normovaná vzdálenost</i>
A	10^{10}	10^{-7}	0,9	-6,954	0,146
B	10^9	10^{-5}	0,7	-4,845	0,297
C	10^9	10^{-4}	0,1	-3,000	0,428
D	10^8	10^{-2}	0,01	0,000	0,643
E	10^6	10^{-1}	0,01	1,000	0,714
F	10^6	1	0,0001	4,000	0,929

Tabulka 5: Vypočtené hodnoty normované vzdálenosti pro kategorii Mainstream

<i>případ</i>	<i>pásmo [Hz]</i>	<i>latence [s]</i>	<i>míra dostupnosti pásma</i>	<i>vzdálenost</i>	<i>normovaná vzdálenost</i>
A	10^{11}	10^{-8}	0,9	-7,954	0,074
B	10^{10}	10^{-6}	0,7	-5,845	0,225
C	10^9	10^{-4}	0,1	-3,000	0,428
D	10^8	10^{-2}	0,01	0,000	0,643
E	10^7	10^{-1}	0,001	2,000	0,789
F	10^6	1	0,0001	4,000	0,929

Tabulka 6: Vypočtené hodnoty normované vzdálenosti pro kategorii Enterprise

úroveň externalizace	popis	navrhovaná hodnota metriky
P2P	ad-hoc integrace. Pro n systémů max. $\frac{n(n-1)}{2}$ integrací	1
adaptéry	standardizace L4 protokolů	2
ad-hoc messaging	MOM pro P2P spojení	3
content-based routing	agregace, publish/subscribe a směrování dle řídicích dat	4
dynamic routing	externalizace řídicích pravidel (konfigurovatelnost)	5
BPM	řízení org. procesů dedikovaným SW nas ESB	6

Tabulka 7: Kvantifikace míry externalizace integračních funkcí mimo integrované aplikace

úroveň DTD jazyka	popis	navrhovaná hodnota metriky
žádný DTD	syntaxe není externalizována	1
vlastní DTD	syntaxe určena vlastní definicí ad-hoc	2
syntaktické XSD	využití CSA standardizace [2], [11]	3
sémantické XSD	využití IS standardizace [2], [9]	4

Tabulka 8: Kvantifikace míry standardizace dat

Dalším důležitým parametrem je *míra standardizace jazyka pro definici dat s*. Opět se jedná o ordinální diskrétní veličinu. Definice je dána tabulkou 8.

Posledním parametrem musí být počet komunikací v rámci relace mezi integrovanými systémy n . Pro zjednodušení zanedbáváme případ bezstavové komunikace typu požadavek/odpověď a hodnotu parametru definujeme jako celkový počet přenosů dat nezávisle na směru. Při *one-way komunikaci* bude tedy $n=1$, při *request/response* bude $n = 2$, při 2 komunikacích tam a zpět bude $n = 4$ etc.

Výše uvedené veličiny zavedeme do výpočtu volnosti vazby c následující úpravou vzorce 3:

$$c^{plain} = \frac{n}{e \cdot s} \left[1 - \frac{1}{D_i + 2C_i + D_o + 2C_o} \right] \quad (4)$$

Je možné, že pro praktické využití bude nutné upravit hodnoty e a s tak, aby lépe vyjadřovaly proporcionalitu mezi definovanými kategoriemi. K úpravě je možné přistoupit až po provedení testovacích výpočtů na reálných scénářích, což zatím nebylo provedeno. Hodnoty těchto veličin mají přímý vliv na obor hodnot volnosti vazby. Z toho důvodu zatím není vhodné navrhnout *normalizovanou míru vazby* tak, jak jsme to provedli pro vzdálenost mezi integrovanými 2.

4.2. Využití normované míry vazby

Na rozdíl od normované vzdálenosti vyjadřuje míra vazby nejen vlastnosti existujícího prostředí, ale dotýká se i samotného návrhu konkrétní integrace (vstupy C_i , D_i , C_o , D_o a n). Normalizovanou míru vazby by tedy

mělo být možné využít přímo ve vyhodnocování kombinací integračních vzorů.

4.3. Degradace výkonu

Nezanedbatelným markerem při objektivizaci integračních řešení je míra degradace výkonu, která úměrně souvisí s volností vazby mezi komunikujícími IS. Uvolnění vazby mezi systémy vynucuje jednak strukturalizaci rozhraní včetně datových formátů a dále pak použití dalších mezilehlých komunikačních prvků pracujících na vyšších vrstvách modelu ISO/OSI [15]. Degradace výkonu je pak dána především:

- Prolongací vytvoření resp. parsování zprávy ve všech bodech scénáře (volající, ESB intermediaries, volaný). V analýze je nutné zvážit jednotlivé vrstvy ISO/OSI, nicméně lze očekávat, že řádově nejvýznamnější bude práce s dokumenty ve formátu XML způsobená DOM transformací [12] a dále pak konverze datových typů do/z řetězového zápisu (viz dále).
- Zvýšení doby potřebné na transport informace sítí kvůli existenci mezilehlých prvků pracujících přímo s aplikačními daty.

Vyhodnocení degradace výkonu již indikuje nutnost rozdělit výpočet po jednotlivých vrstvách modelu ISO/OSI, což překračuje možnosti tohoto článku. Do výpočtu degradace výkonu bude zahrnuta i normovaná vzdálenost integrovaných systémů 2.

5. Závěr

Uvedli jsme přehled a rozbor některých vlastností prostředí, v němž jsou budovány komunikace mezi informačními systémy. Ukázali jsme možnosti jejich strukturalizace a ordinálního ohodnocení. Ukázali jsme

možnosti transformace původně kategoriálních dat na normované číselné hodnoty. Připravili jsme tak část podkladů pro vytvoření metodiky objektivního deterministického hodnocení integračních scénářů založeného na integračních vzorech. Rozbor samotných integračních vzorů nebyl obsahem tohoto článku.

Literatura

- [1] G. Hohpe and B. Woolf, “*Enterprise Integration Patterns*”, Courier Westford, Westford, Massachusetts, 2009.
- [2] The Open Group, “*TOGAF Version 9*”, Van Haren Publishing, Zaltbommel, 2009.
- [3] W. Stevens, G. Myers, and L. Constantine, “*Structured Design*”, IBM Systems Journal, 13 (2), 115-139, 1974.
- [4] Integrační middleware pro zdravotnictví MIRTH, <http://www.mirthcorp.com>.
- [5] Enterprise Service Bus na Wikipedia, http://en.wikipedia.org/wiki/Enterprise_service_bus.
- [6] Orchestrace procesů na Wikipedia, http://en.wikipedia.org/wiki/Orchestration_%28computers%29.
- [7] Business Process Engine na Wikipedia, http://de.wikipedia.org/wiki/Business_Process_Engine.
- [8] Object Management Group, <http://www.omg.org>.
- [9] Web konsorcia HL7, <http://www.hl7.org/>.
- [10] R.H. Elliot, “*XML Bible*”, Wiley, Hoboken, New York, 2001.
- [11] Standard XSD na W3C, <http://www.w3.org/TR/xmlschema-0/>, <http://www.w3.org/TR/xmlschema-1/>, <http://www.w3.org/TR/xmlschema-2/>.
- [12] Standard XSLT na W3C, <http://www.w3.org/TR/xslt>.
- [13] Web Service standardy na W3C, <http://www.w3.org/2002/ws/>.
- [14] Protokol SOAP na W3C, <http://www.w3.org/TR/soap12-part1>.
- [15] R. Pužmanová, “*TCP/IP v kostce*”, Kopp, České Budějovice, 2004.
- [16] Teorie uspořádání množin na Wikipedia, http://cs.wikipedia.org/wiki/Kategorie:Teorie_uspo%C5%99%C3%A1d%C3%A1n%C3%AD.

Infrastructure for Data Storage and Computation in Biomedical Research

Post-Graduate Student:

MGR. TOMÁŠ KULHÁNEK

CESNET, z.s.p.o.
Žitkova 4
160 00 Prague 6, CZ

tomaton@centrum.cz

Supervisor:

ING. MILAN ŠÁREK, CSC.

Department of Medical Informatics
Institute of Computer Science of the ASCR, v. v. i.
Pod Vodárenskou věží 2
182 07 Prague 8, CZ

sarek@euromize.cz

Field of Study:
Biomedical Informatics

This work was supported by research found of CESNET 361/2009 and 384/2010.

Abstract

Infrastructure as a service (infrastructure which is offered to customer in the form of service of the provider) is a deployment model which allows utilize data and computing capacity of a cloud as a set of virtual devices and virtualized machines. Infrastructure as a service can be offered separately to each project. The same capacity of connected physical machines and devices can be shared. Currently, the concept of an Infrastructure as a service is tested on several projects within activity of CESNET association, First Faculty of Medicine, Charles University, Prague and Musical and Dance Faculty of Academy of Performing Arts in Prague.

The current research in the field of computation physiology is demanding on high computation capacity. The computation tasks are distributed to computers, which are provided by the infrastructure. The project in the field of analysis of human voice is demanding on high throughput of computer network between acoustic or video device on the local side and analytic application on remote high performance server side. This paper describes features and main challenges for infrastructure dedicated for such type of application. Infrastructure as a deployment model of cloud computing might be beneficial for multi domain team and for collaboration and integration of high specialized software application.

1. Introduction

The penetration of broadband connection to the Internet with speed at least 2 Mbits per second was about 95% in Czech Republic in the beginning of the year 2011 [8]. Therefore application with higher demand on connection speed becomes more available for general users.

This work discuss examples of application in biomedical research whose deployment relates to high speed network from different perspectives. Even the application demands higher connection rate, they are not limited only to be used in and from high speed network available in academic community (e.g. CESNET2 network in the Czech Republic). Several technologies allows to deploy and use these application effectively and dynamically.

2. Virtualization

Virtualization is a technology which provides separation between software layer and underlying hardware layer. It allows execution of one or more so-called virtual machines sharing one physical hardware. Virtualization techniques introduce some overhead when translating isolated application instruction to lower level of a system, however, performance penalty is generally small on newest hardware and virtualization systems (VMWare, XEN, KVM, ...). Thus the virtualization allows to consolidate hardware capabilities into smaller units which may be utilized effectively.

3. Virtual infrastructure

Several virtual machines which are connected via e.g. virtual network which is routed on the physical network may form a virtual infrastructure. These virtual machines may not necessarily run on one physical machine but may run on different physical machines geographically dispersed. In contrast to virtual infrastructure, they may become a virtual organization is set of users from different physical organizations who for example work on the same project or share same data. Such virtual organization may use a virtual infrastructure which is de-

dedicated only for their purpose. Establishing the virtual infrastructure is more easy with the virtualization techniques.

The following figure shows an example of several virtual organizations and their infrastructures. On the right part there are schematic view on physical connections among

different organizations (hospitals, research institutions) via academic network or the Internet. The physical resources are shown as vertexes and network connections are shown as edges. Each amebe connects virtual machines into virtual infrastructure. On the left part there is a physical server executing more virtual machines, each machine belongs to different virtual infrastructure.

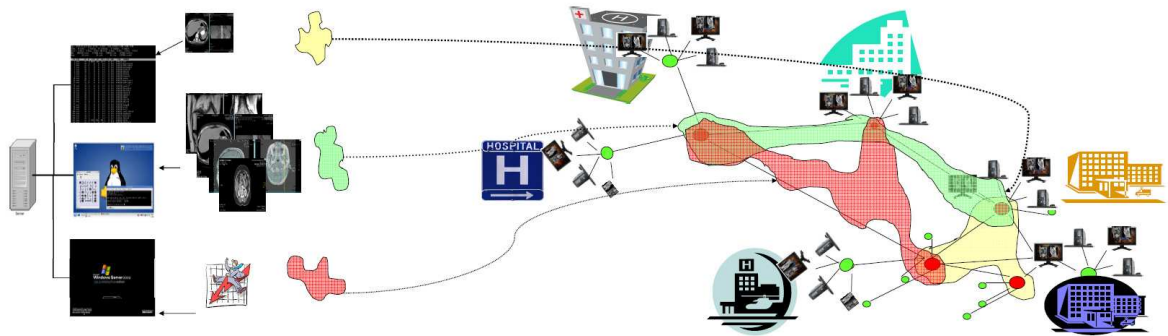

Figure 1: Illustrative schema.

4. National grid and desktop grid

The computational grid is a hardware and software infrastructure that provides dependable, consistent, pervasive, and inexpensive access to high-end computational capabilities [3]. The grid are used e.g. for computation in high energy physics. An additional effort is needed to administer and maintain the grid infrastructure. This task is typically provided by national grid initiative and the grid infrastructure is shared among different independent users. The national grid initiative in Czech Republic is maintained by the METACENTRUM activity part of the association CESNET and coordinates also the work with NGI from neighboring countries in the European Grid Initiative (EGI). In contrast to national grid, there may be established ad-hoc, voluntary or also named desktop grid system. Known project is SETI@home [4] which follows the idea that anyone connected to Internet can join this project and enhance a voluntary grid by downloading small client program and execute it in the background. This small program periodically asks for computational jobs and computes them e.g. as a screen-saver. The grid nodes are typically PCs owned by individuals [5] [6].

5. Cloud computing

Cloud computing is a model for enabling network access to a shared computing resources that can be rapidly provisioned and released with minimal management effort or service provider interaction [7]. The cloud computing is offered in three different types, as a service,

platform or the whole infrastructure. Infrastructure as a Service (IaaS) consists from data-centers, computing resources and network. Like in the grid computing, the user of an infrastructure isn't typically the owner of the infrastructure and doesn't need to maintain the physical hardware. The cloud is currently offered as public cloud by multiple vendors, private cloud may be built using opensource or proprietary software (VMWare vCloud, Eucalyptus, OpenNebula, ...) or hybrid cloud which combines private and public cloud capabilities.

6. Voice signal analysis

The aim of the project FONIATR is to built a system which can analyze input signal such as human voice or video of voice chords and provide a graphical output, which support decision of specialists e.g. phoniatrist or othorynolaryngologist. On top of that, it should collect statistical information and voice samples with context information provided by specialist for further analysis.

The deployment of the application was a local installation on the user's working computer in the past. This deployment model was changed from local installation to a remote installation with remote access. There were considered several technologies and currently used access over remote desktop protocol (RDP) keeps transparency of the application in the meaning, that a user of such application should not notice significant change in use and behavior. Even development of such application doesn't need any changes if there is not specific requirements on quality of data transferred. RDP transfers from user's client appli-

cation events from mouse and keyboard to the remote system where it is interpreted and graphical changes are transferred back to client's application which visualizes it. Due to lack support of sound recording redirection in RDP, there were introduced our own customization for RDP protocol to redirect sound recording over RDP without loss of information [1].

The system currently consists of two distinct parts. One part is client application – generic remote desktop client (part of standard accessories of MS Windows system, or RDESKTOP program for Linux) and a plugin which adds a custom virtual channel and switches on/off recording on the local microphone and redirects digital sound signal through RDP virtual channel.

Second part is an application on a configured server, which can be accessed over Internet. After logging into remote session, this application starts instead of generic desktop and customized server's RDP plugin controls switching on/off recording and receives digital sound signal which it writes to a file on server's disk and provides API to access sound samples. This API is used by analytical application to provide real-time analysis of the voice signal as well as post-processing analysis which is done after recording is finished.

The server part of application is deployed on several virtual machines, each one is accessible for different set of users, currently one is dedicated for development and testing purposes with restricted access, the second one for production with general access.

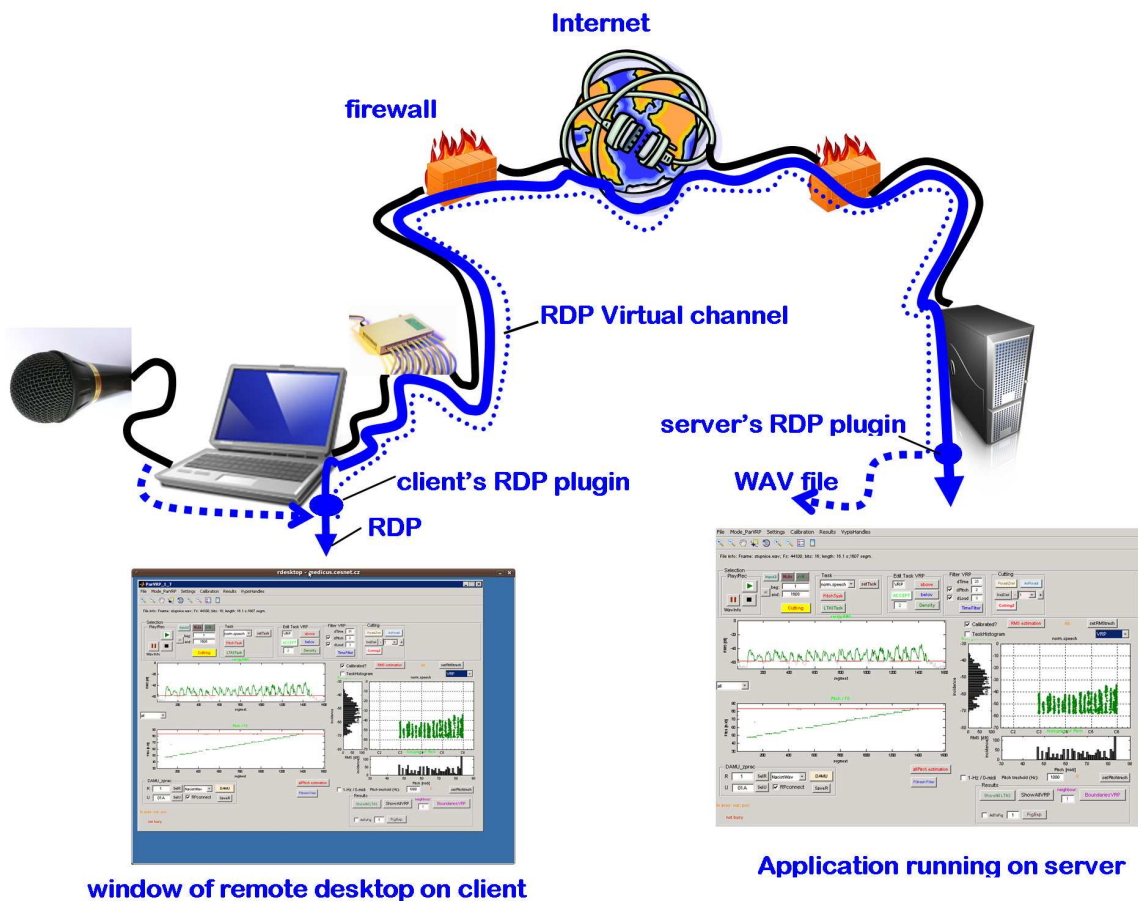

Figure 2: Schema of system for human voice analysis and remote recording via RDP protocol.

7. Identification of physiological systems

The result of the project Identification of Physiological Systems offers a web service distributing the computati-

onal task to desktop computers connected via desktop grid system BOINC and SZTAKI Desktop Grid API [2]. The schema on following figure shows architecture of the system. The server is in operation as an independent virtual machine and contains a SOAP web service controlling the distribution of task over BOINC middleware. Some of the BOINC workers are in operation as independent virtual machines. Some of the desktop computers of laboratory and classroom of First Faculty of Medicine are connected to this desktop grid system. Other computers may be easily joined later. Current research is focused on the possibility to enhance computational capacity of the infrastructure by the resources provided by NGI or involvement of GPU computing.

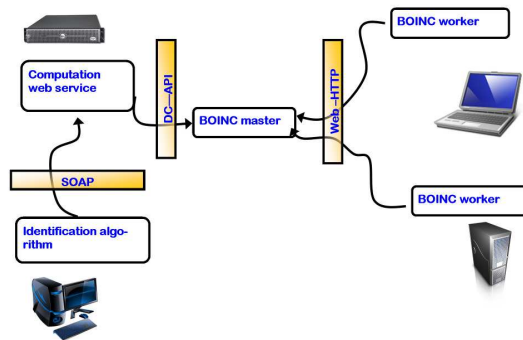

Figure 3: Schema of computational infrastructure for identification of physiological systems.

8. Discussion

Relatively independent project with completely different types of users may share same physical resources and may outsource tasks related to establishing and maintaining IT infrastructure. Virtualization and virtual infrastructures offers such effective way to do that. However as seen in both cases, an effort is needed to implement or adapt communication protocols because single parts of the system is not deployed on single machine and needs to exchange data to work appropriately. Most of them are standardized or can be easily enhanced by custom plugins. The introduced infrastructure can be characterized as a private cloud, which is accessible to users from different communities related to biomedical research. There are not used special tools to administer cloud within the pilot infrastructure, because the number of projects is relatively small currently. Anyway, there exist free or commercial products (Eucalyptus, OpenNebula, VMWare vSphere), which provides set of tools to automatize the maintenance of private cloud, including virtual network configuration, live migration of virtual machine, etc. The important question is: which type of application is suitable for clouds operating on physi-

cal resources spread in different geographical locations compared to clouds operating in supercomputing centers. Cloud in supercomputing centers are suitable for highly parallel tasks which needs fast communication between parallel computational tasks. Cloud operating on physical servers in different geographical locations can offer a free capacity in the time period, when the owner doesn't utilize its physical resources and offers them to other users of cloud.

9. Conclusion

It's possible to operate private cloud on the physical infrastructure and to provide virtual infrastructure to the users, who can utilize it to execute their own applications and systems. Infrastructure as a service can open an access to distributed systems to higher amount of users, who have been so far prevented from using them by complicated administration, too long process of purchasing and installing computing resources. This type of advanced application are available to any user via Internet, it has reasonable responsiveness when connecting via broadband connection. The cloud operating on physical servers in different geographical locations can be a suitable complement to the clouds in supercomputing centers.

References

- [1] T. Kulhánek, M. Frič, and M. Šárek, "Remote Analysis of Human Voice – Lossless Sound Recording Redirection", *Proceedings of Biosignal 2010 Analysis of Biomedical Signals and Images*, ISSN 1211-412X, ISBN 978-80-214-4106-4.
- [2] T. Kulhánek, J. Šilar, J. Kofránek, M. Mateják, P. Privitzer, and M. Tribula, "From Educational Models Towards Identification of Physiological Systems", *Mefanet Report 04*, ISBN 978-80-210-5539-1, <http://www.mefanet.cz/res/file/reporty/mefanet-report-2011.pdf>.
- [3] I. Foster and C. Kesselman, "Computational grids", *Vector and Parallel Processing*, VECPAR 2000, 2001 – Springer.
- [4] D.P. Anderson, J. Cobb, E. Korpela, M. Lebofsky, and D. Werthimer, "SETI@home: an experiment in public-resource computing", *Commun. ACM* 45, 11, 56-61, 2002.
- [5] D.P. Anderson, "BOINC: A System for Public-Resource Computing and Storage", *In Proceedings of the 5th IEEE/ACM international*

- Workshop on Grid Computing* IEEE Computer Society, Washington, DC, 4-10.
- [6] Z. Balaton, G. Gombás, P. Kacsuk, A. Kornafeld, J. Kovács, C.A. Marosi, G. Vida, N. Podhorszki, T. Kiss, “SZTAKI Desktop Grid: a Modular and Scalable Way of Building Large Computing Grids”, *Proceedings of the 21st International Parallel and Distributed Processing Symposium (IPDPS 2007)*, 26-30 March 2007, Long Beach, California, USA.
- [7] P. Mell and T. Grance, “The NIST Definition of Cloud Computing”, *National Institute of Standards and Technology*, 53(6), 50. NIST. <http://csrc.nist.gov/groups/SNS/cloud-computing/cloud-def-v15.doc>.
- [8] Akamai, “State of the Internet”, *Q1 2011 report*, <http://www.akamai.com/stateoftheinternet/>.

Numerical Algorithms for Low-Rank Matrix Completion Problems

Post-Graduate Student:

BC. MARIE MICHENKOVÁ

Charles University in Prague
Faculty of Mathematics and Physics
Ke Karlovu 3
121 16 Prague 2, CZ

m.michenkova@seznam.cz

Supervisor:

RNDR. IVETA HNĚTYNKOVÁ, PH.D.

Institute of Computer Science of the ASCR, v. v. i.
Pod Vodárenskou věží 2
182 07 Prague 8, CZ

strakos@cs.cas.cz

Field of Study:

Numerical and Computational Mathematics

Abstract

We consider a problem of recovering low-rank data matrix from sampling of its entries. Suppose that we observe m entries selected uniformly at random from an $n_1 \times n_2$ matrix M . One can hope that when enough entries are revealed, it is possible to recover the matrix exactly. We downloaded eight solvers implemented in Matlab for low-rank matrix completion and tested them on different problems. The talk will include a brief description of the solvers and a discussion of the results we obtained.

Nová zastavovací kritéria pro Cascadic Conjugate Gradient Method

doktorand:

MGR. JAN PAPEŽ

Karlova univerzita v Praze
Matematicko-fyzikální fakulta
Sokolovská 83
186 75 Praha 8

jan@papez.org

školitel:

PROF. ING. ZDENĚK STRAKOŠ, DRSC.

Ústav informatiky AV ČR, v. v. i.
Pod Vodárenskou věží 2
182 07 Praha 8

strakos@cs.cas.cz

obor studia:

Vědecko-technické výpočty

Abstrakt

Cascadic Conjugate Gradient Method (CCG, [Deuffhard 1994]) je metoda pro řešení eliptických parciálních diferenciálních rovnic. V příspěvku uvedeme (a posteriorní) odhady algebraické a diskretizační chyby, popíšeme metodu CCG a navrhneme pro ni nová zastavovací kritéria. Ta jsou poté v numerických experimentech porovnávána se zastavovacími kritérii odvozenými v původním článku.

The Neural Networks Methodology of the Short-Term Electricity Consumption Forecasting

Post-Graduate Student:

MGR. PETR PAŠČENKO

Faculty of Mathematics and Physics
Charles University in Prague
Malostranské náměstí 25
118 00 Prague 1, CZ

petr.pascenko@matfyz.cz

Supervisor:

MGR. ROMAN NERUDA, CSC.

Institute of Computer Science of the ASCR, v. v. i.
Pod Vodárenskou věží 2
182 07 Prague 8, CZ

roman.neruda@cs.cas.cz

Field of Study:
Computational Intelligence Models for Data Processing

This work was supported by ČEZ, a.s.

Abstract

This paper shows the methodology used for the design of the short-term electricity power consumption model with a hour resolution. The key fundamental drivers (temperature, industry, seasonalities) are identified and their relative impact is estimated by the statistical analysis. The neural model based on the negative correlation ensemble is presented. The final model is enhanced by linear auto-regression correction. The final model percentage absolute error is about 1.2.

1. Introduction

Suppose we have an electricity transmission grid. This grid serves as an underlying infrastructure for transferring an electrical power from electricity producers to its consumers. On the supply side of this equation, there is a set of various power plants of many different types and properties. On the demand side, there is a significantly higher number of electricity end users: households, industrial and transport facilities, public as well as private services, etc.

From the economical point of view, there are a supply and a demand, and thus a suitable place for the market. This market really exists, as a special form of the commodity market. The speciality of the electricity market lays in the fact, that the commodity itself, the electrical power, could not be efficiently stored. In every single moment, the total volume of the generated power must follow very closely the total amount of power consumed, otherwise, the grid may collapse. That is why the market rules and mechanisms are set in the way that benefits the behaviour of market participants, that contributes to the stability and predictability. Also, compared to the other commodities, short-term consumer decisions are not affected by the price of the commodity. Non of us switch

off the light just because there is a temporal shortage in the grid.

The previously mentioned facts makes it vital for all the market participants including power producers, distribution companies, as well as purely financial power traders, to be able to anticipate the future levels of the power consumption as a key market driver.

In this article, a methodology of a building of a model for short-term consumption forecast will be described. First, the electricity consumption is rigorously defined in the introduction to the sec. 2 and the results of the initial statistical analysis of the main consumption drivers is presented in the sec. 2.1. In the section 3 the neural model based on the negative correlation ensemble (sec. 3.1) is presented including inputs (sec. 3.2) and outputs (sec. 3.3) description. In the section 3.4, the model performance is discussed.

2. Consumption

The overall *electricity consumption* of a specified grid (in this case The Czech Republic) is a value, estimated as the load of the grid reduced of the transmission losses, pumping storage consumption and the current import/export balance. The load itself is estimated as the total electricity generation at the moment minus the self consumption of the sources.

The consumption is thus always an estimate. Moreover, only larger generation facilities report their output on line. Mainly the renewable sources (solar, wind, and minor hydro), that are also hardly predictable, report at best with several days delay. For the purposes of this analysis, the time series of the Czech consumption retrospectively published by ČEPS, a.s., the Czech national transmission system operator, is used.

2.1. Analysis

From the statistical point of view, the consumption variable is a sum of the power input of all currently operating appliances i.e. an aggregate value of large number of random variables. This attribute of consumption time series creates a potential of a suitable precise predictions. However, the variance of the series is relatively high. A long term average consumption of the Czech Republic is approximately 8000 MW, but the maximal

levels exceeds 11 000 MW while minimal levels are below 4 500 MW.

Seasonality: The time series of the consumption is strongly seasonal. There are three major seasonal cycles clearly noticeable on the curve. First is the year cycle (see Figure 1), having its maximal levels in the beginning of January and its minimum in between July and August. This cycle, with the amplitude about 1 800 MW, is mainly caused by the air temperature and heating season (in winter) and the vacation period (in the summer).

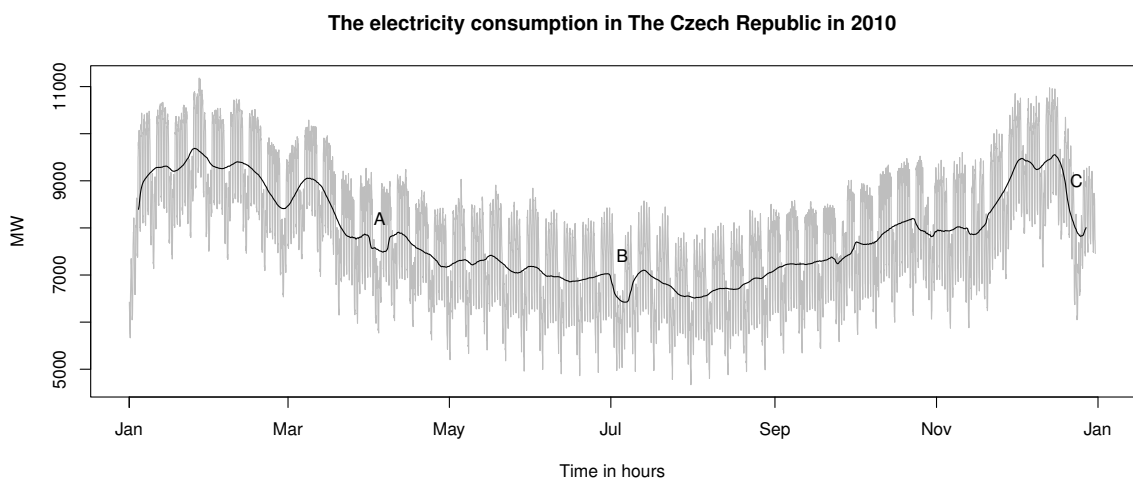

Figure 1: The course of the Czech electrical consumption in the hour resolution. The black line of the long-term moving average represents the intra-year seasonality with several identified irregularities. A – Easter, B – Mass vacations of various industry corporations, C – Christmas.

The second seasonality is the clearly observable week period having its maximum on Wednesday and Thursday, while minimum clearly appears on weekends especially on Sunday. This regular pattern is caused by the business cycle having its amplitude about 700 MW. The final regular pattern is the intra-day load curve, commonly called “camel back” having its maximum at 11 o’clock and minimum between 4 and 5 in the morning with its amplitude about 800 MW.

Figure 1 documents, that the regular course of the long-term consumption is significantly disrupted by several deviations, three major ones are signed by letters. All public holidays on work days causes significant decrease of consumption, but not all of them equally large. The strongest outage is caused by Christmas and Easter. There is a lot of nuances in the impact of particular day off, depending on its position in the week, season, and other factors. If the day forms so called longer weekend, the impact is usually stronger. Also a phenomenon

called bridge day — a work day between two free days — is well known to energetics being even harder to properly predict.

Trend Factors: Although the long term trend forecast is not a significant part of a short-term model construction, the identification of past trend factors is a vital part of the analysis. Several economical indicators have been examined in order to explain the temperature independent year on year changes. The most precise correlation has been discovered in the Industrial Production Index (IPI), published by Eurostat with approximately 3 months lag. Figure 2 shows the daily consumption in work days normalised to 20°C fitted by the course of IPI. The relation is clearly linear with the ratio of 23 MW per point, when the 100 points refers to the average industrial production of year 2005. The remaining difference between years remains neglectable compared to the effect of IPI and does not overcome 50MW year on year.

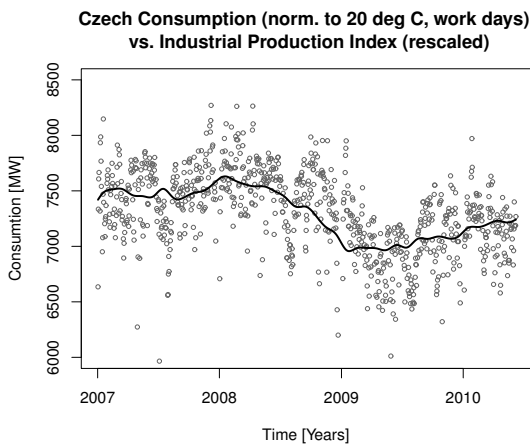

Figure 2: The average daily consumption of work days (grey circles). The black line represents the linearly rescaled course of industrial production index.

Temperature and other weather conditions: As it was already mentioned, the air temperature is the most formative factor affecting the consumption. On the chart of the year consumption course (Fig. 1) there can be identified the heating season (approx. Oct-Apr). The analysis shows a smooth threshold being about 12-13°C of the air average temperature. The dependency of the temperature is not linear and the statistical analysis interestingly shows stronger correlation of the current day electricity consumption with previous days average air temperature, rather than the temperature of the current day. The maximal correlation is achieved using the 3 days moving average. Figure 3 shows the fit of a simple neural model where the actual and previous air temperatures are taken as an input. This model overperformed similar linear and quadratic model suggesting a close to sigmoidal course of the dependency.

Together with the air temperature, two other weather variables were examined in order to analyse the effect of the sun light intensity to the electricity consumption. The first of them is the so called *normal irradiation* characterising theoretical maximal amount of the solar energy falling on specific point on the earth surface in the particular moment. The second value is the *cloud cover* — a sort of meteorological value describing the fraction of the sky covered with clouds. This value is measured in *okta* — ($\frac{1}{8}$), 0 stands for clear sky, while 8 for full cloud cover. Unfortunately, according to the consultation with meteorologists, the cloud cover values are not currently measured automatically but only by empiric human observation or rather estimate.

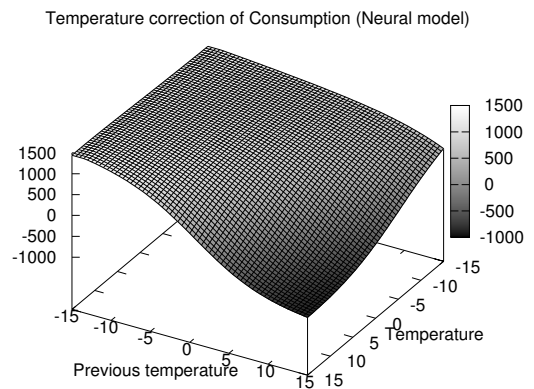

Figure 3: The dependence of the consumption on the current day temperature and the temperature of previous three days.

Moreover the cloud cover does not even try to measure the quality of the clouds, thus the high atmosphere light cloudiness is weighted exactly as dark and heavy storm clouds, although the shadow magnitude is completely different. In spite of these facts, both of these values proved to be statistically relevant. A rough estimate of the effect of one *okta* on the total consumption is about 20MW. Note that this estimate seems to be realistic, considered the fact the total power consumption of the public street light system is about 75 MW.

3. Model

The regression model from a general scope is a sort of function, having its input and output variables. Two kinds of inputs can be identified: let us call them explicit and implicit. The explicit inputs (such as temperature or sun-light) vary from pattern to pattern and they (are the thing *what*) directly affect the output. The implicit inputs are typically unknown, they do not change much during the time but they affect the way *how* is the output linked with the input. An example of such parameters could be a number of households that use an electrical heating or a fraction of companies closed during the Christmas. There is an effort when designing the model to keep the explicit parameters as the model inputs and let the model to train the implicit parameters from the data.

The goal is to build a neural model of the consumption with an hour resolution. The straightforward approach would be a network with a set of statistically identified input variables and a single output describing the consumption. Various hours of the day are however dependent on the inputs in very different manner. Consider the sun light being a crucial parameter at 7 o'clock

in the morning while totally dismissable parameter at 12 o'clock at night. To make the model distinguish between the hours, another inputs describing the position of the hour in the daily diagram would have to be involved.

That is however a pure example of an involvement of the implicit parameters (the way how the input should be processed) as an explicit parameter of the model. That is why another approach is chosen. The basic model unit is constituted of the neural network of classical multi-layer perceptron design with multidimensional output. The model input consists of previously mentioned statistically relevant variables, while the output forms the 24 variables — one for every value in the daily consumption diagram. An alternative approach would be training 24 networks with a single output. Two reasons favour the single model: firstly, a useful interaction of neighbouring hours during the training strengthening the generalisation abilities of the model could be expected, secondly, to keep a set of 24 models together with the intention of building the ensemble would be considerably impractical.

3.1. The negative correlation ensemble

The theoretic idea behind grouping neural networks into ensemble models is the reduction of an error variance under the condition of not increased an error bias. At least a minimal level of discrepancy and independence of the member networks is silently expected. In order to involve such discrepancy, various methods could be used such as training set alternation or ensemble pruning. In this article, the approach of *negative correlation ensemble learning* [3] is applied. As the name of the method suggests, the algorithm of negative correlation learning focuses on the reduction of the covariance between the output of individual networks while simultaneously keeping the bias of the networks suitably low.

The ensemble consists of a set of uniform networks trained on the identical training set. The ensemble output $F(x_i)$ is computed as an unweighted mean of the M member network outputs $F_j(x_i)$ for a particular pattern x_i .

$$F(x_i) = \frac{1}{M} \sum_{j=1}^M F_j(x_i)$$

All member networks are trained simultaneously to reduce their error and to differ one from the others by altering the penalty function. In the standard back-propagation [2] algorithm, the learning error for a single network is calculated as:

$$E_j = \frac{1}{N} \sum_{i=1}^N E_i = \frac{1}{N} \sum_{i=1}^N (F_j(x_i) - y_i)^2$$

In the negative correlation algorithm, an error describing the correlation is added:

$$E_j = \frac{1}{N} \sum_{i=1}^N (F_j(x_i) - y_i)^2 + \frac{1}{N} \sum_{i=1}^N \lambda p_{j,i}$$

where

$$p_{j,i} = (F_j(x_i) - F(x_i)) \sum_{k \neq j} (F_k(x_i) - F(x_i))$$

Note that the λ parameter is advised to vary between 0 (independent training) and 1 (single huge network). There is no rigorous way to adjust the parameter. The empirical value giving the best results for this experiment is about 0.8.

3.2. Input

The basic set of input variables roughly follows the conclusion of the previously mentioned statistical analysis. First of all, 3 **temperature** inputs: the values of an average daily air temperature, daily minimal temperature and also the average of three previous daily temperatures. The temperature inputs were calculated as a population fraction weighted mean of values measured in the three major cities: Prague, Brno and Ostrava. To determine the level of sun light, two previously mentioned variables, the normal irradiation and the cloud cover were involved.

The trend compartment is represented by the value of **IPI** (see Fig. 2). The currently unknown future values were estimated using the forecast of the GDP growth published by the ČNB. The seasonalities are represented by an unary coded set of **dummy variables**, one per every day of week and one per every year. The last currently unfinished year shares the dummy with the previous year.

Several iterations of model training were performed in order to determine the major error cases. A few other variables had to be included. The first of all the state and the religion holidays had to be involved as a special dummy as well as the previously mentioned bridge days. It turns out that the so called Christmas week (usually between the 24th of December and the 1st of

January) exhibits a systematic decrease of power consumption and thus deserves its own input. Finally a variable indicating a longer weekend (a weekend preceded or followed by a holiday) and a border day (a work day just before or just after such longer weekend), were added.

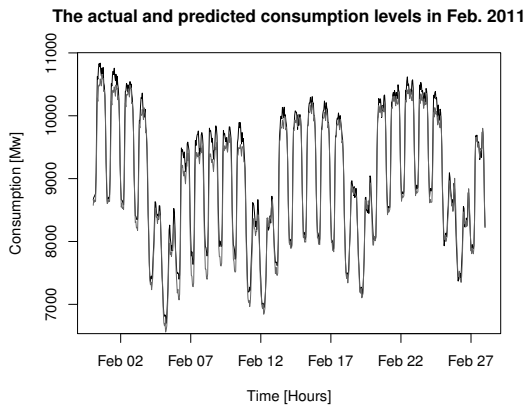

Figure 4: The test set model performance. The course of actual consumption (black) and the day ahead forecast (gray) in February 2011.

Another two periodical events had to be considered. First is the beginning of the summer holiday, traditionally followed by the mass vacation in many industrial factories causing a considerable decrease of the power consumption. Second is the day-light saving time change in March and October. In spite of the common belief, the effect of the day-light saving on the sum of power consumption is purely marginal, however what is moderately affected is the daily diagram shape. For both events a dummy was included in the set of model inputs.

3.3. Output

As previously mentioned, the model has 24 outputs describing the hourly consumption levels. As the consumption is a summative variable, the output variables reflect the absolute value of consumption rather than a difference from the consumption normal or another commonly used difference coding. This approach is motivated by the afford of modelling the contribution of specific inputs to the total consumption as well as their interactions.

3.4. Performance

The model was trained on the historical data that covers the years 2007-2010. The last training set member is the 6th of December 2010. Since this point, the model was not retrained and it runs every day as a consumption fo-

recaster using the currently most plausible weather forecast. The current test set thus contains the time period between Dec 2010 and June 2011.

The MAE of the day ahead prediction of the model in the hour resolution on the specified test set is 124.2 MW and corresponding PMAE 1.5%. Several notoriously precarious events over the year can be identified. If the Christmas week for instance is omitted from the test set, the MAE value decreases to 114.8 MW (PMAE to 1.4%).

The performance of the model varies during the year and it is significantly dependent on the weather forecast quality. In the summer the weather is more stable and the level of irregularity of the consumption is lower. In that period, the model forecast is almost perfect (see Fig.5).

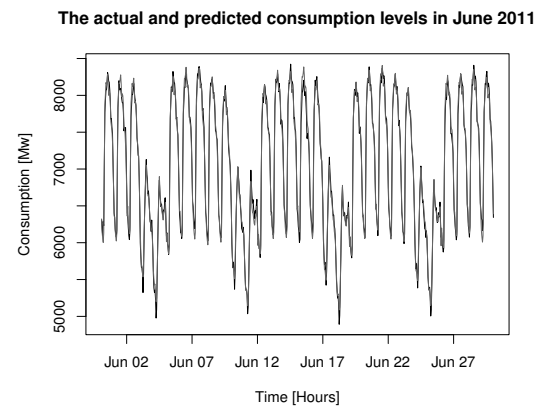

Figure 5: The test set model performance. The course of actual consumption (black) and the day ahead forecast (gray) in June 2011.

On the contrary, the winter time and even more the transition period of the early spring is characterised by hardly predictable weather that significantly affect the model performance (see Fig. 4). A serious source of the prediction error is the so called inversion cloudiness characterised by the lower clouds and fogs that lay below the minimal altitude level of the meteorological models of cloud cover.

To improve the performance of the model for the day ahead forecast, a simple auto-regression correction based on the previous day error was implemented. This small enhancement reduced the day ahead error to 94.3 MW (PMAE to 1.2%).

4. Summary

In this article, a complete methodology of the neural model for the short-term consumption forecast is briefly described. The final model performance with the error about 1.2% can be considered as successful example of neural network application to the real industry problem.

The building of the model with a hour resolution is a difficult task demanding several fundamental decisions. The model presented in the article splits the objective consumption drivers from the auto-regressive inputs and thus can be used for scenario based long term predictions. Still, when present, the information about the previous course of the consumption can be also utilised by the linear regression correction. For the future work, this simple mechanism can be replaced by more sophisticated sub-model in order to improve the total model performance.

Another topic for the future work is the way, how the model deal with the irregularities such as holidays and

Christmas. There is no doubt, that these events are a significant source of model error and a sort of special model dealing with them can be useful. The alternative of splitting the training set to well chosen sectors such as seasons or work/free days in order to train more specialised models is another great topic.

References

- [1] H. S. Hippert, D. W. Bunn, and R. C. Souza, "Large neural networks for electricity load forecasting: Are they overfitted? ", *International Journal of Forecasting*, pp. 425-434, 2005.
- [2] D. E. Rumelhart, G. E. Hinton, and R. J. Williams, "Learning internal representations by the error propagation", *Parallel distributed processing, Vol. 1-foundations*, MIT Press, 1986.
- [3] Y. Liu and X. Yao, "Ensemble learning via negative correlation", *Neural networks*, pp. 1399-1404, 1999.

Multiobjective Memetic Algorithm with Local Meta-Models

Post-Graduate Student:

MGR. MARTIN PILÁT

Faculty of Mathematics and Physics
Charles University in Prague
Malostranské náměstí 25
118 00 Prague 1, CZ

Martin.Pilat@mff.cuni.cz

Supervisor:

MGR. ROMAN NERUDA, CSC.

Institute of Computer Science of the ASCR, v. v. i.
Pod Vodárenskou věží 2
182 07 Prague 8, CZ

roman@cs.cas.cz

Field of Study:
Theoretical Computer Science

This work was supported by Czech Science Foundation project No. 201/09/H057
and by GAUK under project No. 345511.

Abstract

The use of meta-models has a long tradition in the field of evolutionary computation. However, it is not well studied in the field of evolutionary multiobjective optimization. In this paper, we present a multiobjective evolutionary algorithm with local meta-models and compare its performance to traditional multiobjective evolutionary algorithms.

1. Introduction

Evolutionary algorithms for multiobjective optimization are among the best methods for solving optimization problems with multiple objectives.

In the past years several multiobjective evolutionary algorithms (MOEA) [1–4] were proposed and used to deal with these problems. However, most of them require lots of evaluations of each objective function, which makes them problematic to use for solving real life problems. These problems may have complex objective functions whose evaluations are expensive (either in terms of time or money).

Two main approaches are used to make the MOEAs more usable. One of them is parallelization, the other is the use of meta-models. Parallelization only helps to reduce the overall run-time, however, any costs associated with the evaluation (i.e. running a physical experiment) remain.

Meta-models aim at lowering the number of objective function evaluations in a different way. They replace the original objective function with a model of it. There are a few ways to obtain these models. One of them, used especially in engineering, is to use a different physical model (some of the less important variables can

be ignored). Another approaches use response surface methods, regression, or different mathematical methods. Yet another approach is to use a computational intelligence based model, e.g. RBF networks and multilayer perceptrons.

In this paper, we present our multiobjective evolutionary algorithm with aggregate meta-model, but first, we define the problem of multiobjective optimization, briefly present existing multiobjective evolutionary algorithms (MOEA) and describe the use of meta-models in MOEAs. Finally, our algorithm is compared to existing MOEAs in terms of the number of needed objective function evaluations.

2. Multiobjective optimization

Contrary to single-objective optimization, in multiobjective optimization there are more objective functions, which shall be optimized simultaneously. These objective functions are usually conflicting, and thus there is not a single solution, which would be optimal for all of them. This leads to a set of so called Pareto optimal solutions.

The following definitions introduce the multiobjective optimization problem and the Pareto dominance relation, which is used to compare two potential solutions to the problem.

Definition 1 The *multiobjective optimization problem (MOP)* is a quadruple $\langle D, O, \vec{f}, C \rangle$, where

- D is the *decision space*
- $O \subseteq \mathbb{R}^n$ is the *objective space*
- $C = \{g_1, \dots, g_m\}$, where $g_i : D \rightarrow \mathbb{R}$ is the set of *constraint functions (constraints)* defining the *feasible space* $\Phi = \{\vec{x} \in D | g_i(\vec{x}) \leq 0\}$

- $\vec{f} : \Phi \rightarrow O$ is the vector of n objective functions (objectives), $\vec{f} = (f_1, \dots, f_n)$, $f_i : \Phi \rightarrow \mathbb{R}$

$\vec{x} \in D$ is called the *decision vector* and $\vec{y} \in O$ is denoted as the *objective vector*.

Only minimization problems are usually considered as maximization and mixed problems may be easily transformed to minimization ones.

In the field of multiobjective optimization, problems with more than 4 objectives are often called many-objective, as this higher number of objectives poses another challenges for the MOEAs (e.g. the dominance relation defined in the next paragraph loses its power to discriminate between good and bad individuals as most of them are mutually incomparable).

To compare two decision vectors, we define so called Pareto dominance relation. If one vector is better (has lower objective values) for all of the objective functions, we say it dominates the other vector. This is formally stated in the following definition.

Definition 2 Given decision vectors $\vec{x}, \vec{y} \in D$ we say

- \vec{x} weakly dominates \vec{y} ($\vec{x} \preceq \vec{y}$) if $\forall i \in \{1 \dots n\} : f_i(\vec{x}) \leq f_i(\vec{y})$.
- \vec{x} does not dominate \vec{y} ($\vec{x} \not\preceq \vec{y}$) if $\vec{y} \preceq \vec{x}$ or \vec{x} and \vec{y} are incomparable

Now, we can state the goal of the multiobjective optimization, it is to find those decision vectors, which are minimal in the Pareto dominance relation.

Definition 3 The *solution of a MOP* is the *Pareto (optimal) set*

$$P^* = \{\vec{x} \in \Phi \mid \forall \vec{y} \in \Phi : \vec{y} \not\preceq \vec{x}\}$$

The projection of P^* under \vec{f} is called the *Pareto optimal front*.

The Pareto optimal set is usually infinite for continuous optimization and thus we usually seek a finite approximation of this set. This approximation should be close to the Pareto set (ideally it is a subset of it) and should also be evenly distributed along the Pareto front.

We can extend the Pareto dominance relation to such approximations and compare them with this relation, however, as the ordering is only partial, there would be pairs of approximations which are mutually incomparable (in fact, most of such pair would be incomparable).

As we want to compare approximations, which are solutions found by a multiobjective optimizer, we need a way to compare any two sets.

During past years, many measures were proposed to compare such Pareto set approximation and one of the most often used is the hypervolume indicator [5]. This indicator expresses the hypervolume of the objective space, which is dominated by the solutions.

Definition 4 Let $R \subset O$ be a reference set. The *hypervolume metric* S is defined as

$$S(A) = \lambda(H(A, R))$$

where

- $H(A, R) = \{x \in O \mid \exists \vec{a} \in A \exists \vec{r} \in R : \forall i \in \{1, \dots, n\} : f_i(\vec{a}) \leq x_i \leq r_i\}$ where f_i is the i -th objective function
- λ is Lebesgue measure with $\lambda(H(A, R)) = \int_O \vec{1}_{H(A, R)}(z) dz$ and $\vec{1}_{H(A, R)}$ is the characteristic function of the set $H(A, R)$

The reference set bounds the hypervolume from above. It usually contains only a single reference point. We should note here that although the definition of the hypervolume indicator is quite simple, its computation is known to be #P-complete and its complexity grows exponentially with the number of objectives.

3. Multiobjective evolutionary algorithms

Traditionally, evolutionary algorithms have one fitness function. However, in multiobjective optimization, we need to optimize multiple functions at once. Another difference is that in multiobjective optimization we seek a set of solutions instead of a single one. This implies there are some differences between single-objective and multiobjective evolutionary algorithms.

MOEAs usually do not return a single solution, rather the whole population in the last generation (or an external archive) are returned as the solution. The algorithms also differ in how they select individuals to the next generation. They can be divided into three groups based on the type of selection they perform.

First group, represented by the oldest multiobjective evolutionary algorithm uses some kind of scalarization, or aggregation, during the fitness assignment. VEGA [6], the oldest MOEA, used different objective function in each generation, thus finding compromise solutions. However, this often leads to convergence towards the optima of the respective objective functions and only

a few compromise solutions remain in the population. Newer algorithm from the same group, MSOPS [7], uses weighted sums of objectives to create a ranking matrix, which is later used during the selection (as a simplification: objective vectors, which yield better values of the weight sum more often are better and have higher probability of being selected).

Another group of algorithms, represented e.g. by the well-known NSGA-II algorithm [1], uses the dominance relation during the selection process. Usually, the population is divided into so called non-dominated fronts. Individuals which are not dominated by any other in the population are assigned front number 1. These are temporarily removed and individuals non-dominated by the rest are assigned front number 2, this process is iterated as long as there are any individuals in the population. Then, individuals from fronts with lower number are selected first. There are usually other criteria to discriminate between individuals in the same front, in the case of NSGA-II it is so called crowding distance, which roughly corresponds to the distance to the closest individual in the objective space (and individuals from less crowded regions are given preference).

Yet another group of algorithms is based on indicators. These indicators usually somehow refine the dominance relation. One of the algorithms in this group is IBEA [3]. This algorithm uses binary indicator, which compare two individuals to assign the fitness in the following way: the indicator value of each pair of individuals is computed, and an individual i is assigned fitness

$$F(i) = \sum_{j \in P \setminus \{i\}} -e^{-I(\{j\}, \{i\})/\kappa}$$

Here, κ is a scaling factor which has to be set in advance. The purpose of the exponential is to amplify the differences between dominated and non-dominated individuals. An example of such an indicator may be the $\epsilon+$ indicator which expresses, how much an objective vector needs to be moved to become dominated by the other vector. The following definition states this formally.

Definition 5 Let A, B be two decision vectors

$$I_{\epsilon+}(A, B) = \min_{\epsilon} \{ \forall \vec{x} \in B \exists \vec{y} \in A : f_i(\vec{y}) - \epsilon \leq f_i(\vec{x}) \}$$

Indicator based MOEAs are among the most modern ones. Some of them even use the hypervolume indicator directly. In this case, they must somehow overcome the complexity of the computation of this indicator, to be able to scale well for problems with many objective function. One of such algorithms, HypE [4], solves this problem by using Monte Carlo sampling to compute the hypervolume indicator.

4. Meta-models in MOEAs

When dealing with single-objective problem, there are three main ways of incorporating the meta-model in the evolutionary algorithm:

- Meta-models are used directly instead of the fitness function – the fitness function is replaced by the meta-model and the meta-model is optimized. In the extreme case, this is done in the beginning and the model never changes thereafter, more usually the model is updated after a given number of generations.
- Meta-models are used to pre-evaluate individuals – each individual is evaluated by the meta-model to estimate its quality, but only the best individuals are evaluated by the original fitness function.
- Meta-models are used in some kind of memetic operator – this operator takes some of the individuals and moves them closer to the (local) optimum of the meta-model. Gradient methods and other local optimization methods (even evolutionary algorithms) may be used in this case.

With multiobjective optimization, the situation is more complicated, as the approaches differ in what and how the models predict. In one of the first approaches [8] its authors used the NSGA-II [1] and replaced the objective functions with their meta-models.

Other algorithms use some kind of aggregation of the objectives. In [9] authors describe an aggregate meta-model based on the combination of One-Class SVM and Support vector regression. Their model is trained to differentiate between dominated and non-dominated individuals, and it is used during the evolution to pre-evaluate the individuals and drop those who are not promising. The same authors in [10] proposed a similar approach based on rank-based SVM [11].

Although the memetic variant is also possible in multiobjective setting, only a few references were found in the literature which deal with meta-model assisted multiobjective memetic algorithms. In [12] the authors propose such an algorithm. They use a meta-model (in this case RBF networks are used) for each of the objective functions. During the local search one of the objectives is selected for refinement, and a local meta-model is trained and used during the local search.

In [13] the authors propose another method: they use a single-objective meta-model assisted evolutionary algorithm in the local search phase. Two different local meta-

models are used, both trained to approximate a weighted sum of the objectives. One is an ensemble model, the other is a low order polynomial. Two single-objective algorithms are run to find optima of the respective models, which are then precisely evaluated. A selection procedure is then used to decide which of the individuals (if any) is added to the population.

In this paper, we present another multiobjective memetic algorithm with aggregate meta-model.

5. LAMM-MMA

LAMM-MMA is a variant of another algorithm we proposed earlier called ASM-MOMA [15]. ASM-MOMA uses the distance to the currently known Pareto front as the target value predicted by the meta-model. This meta-model is used inside a memetic operator, which improves some of the individuals in the population.

This operator uses only meta-model evaluation, and thus does not increase the number of the real objective function evaluations, which are considered expensive.

The main difference between ASM-MOMA and LAMM-MMA is that LAMM-MMA uses local meta-models instead of a single global one.

More specifically: LAMM-MMA uses an existing multiobjective evolutionary algorithm (almost any of them can be used) and adds a memetic operator and an archive of evaluated individuals. This archive is used during the creation of a training set for the meta-model.

The memetic operator improves the individual I from the current population in this way: Given the archive of evaluated individuals A the weighted training set for individual I in the current population is created as

$$T_I = \left\{ \langle (x_i, y_i), w_i \rangle \mid \begin{array}{l} y_i = -d(x_i, P), \\ w_i = \frac{1}{1 + \lambda d(x_i, I)} \end{array} \right\}$$

where $d(x, y)$ is the Euclidean distance of individuals x and y in the decision space, P is the set of non-dominated individuals in the archive and $d(x, P)$ is the distance of individual x to the closest point in the set P . λ is a parameter which controls the locality of the mo-

del, larger values of λ lead to more local model, whereas lower values lead to more global one.

A meta-model is that trained using this training set. We used three different types of meta-models during the testing: linear regression, support vector regression, and multilayer perceptrons. However, other types of models may be used, e.g. RBF networks are also a common choice in this field.

Finally, after the model is trained, a single-objective evolutionary algorithm with the meta-model as its fitness function is started. The initial population of this algorithm is created by the perturbation of the values of the individual I . The individual I is also added to the initial population. This evolutionary algorithms seeks the local optima of the meta-model around the individual I . The best individual found is then returned to the population of the external multiobjective algorithm as the result of the memetic operator.

After each iteration of the external algorithm, the newly evaluated individuals are added to the archive of evaluated individuals and this archive is truncated, so it does not grow indefinitely, and does not use large amounts of memory. The truncation procedure is very simple: random individuals from the archive are selected and removed to shrink the size of the archive under a specified limit. Although the procedure is rather simple, it ensures that individuals from the more recent generations remain in the archive with higher probability than older individuals. We also tried other truncation strategies (e.g. one similar to the selection procedure in NSGA-II), but the random strategy works significantly better.

6. Experiments

To compare the results we use a measure we call H_{ratio} , it is defined as the

$$H_{ratio} = \frac{H_{real}}{H_{optimal}}$$

where H_{real} is the hypervolume of the dominated space attained by the algorithm and $H_{optimal}$ is the hypervolume of the real Pareto set of the solutions. As the Pareto set is known for all the ZDT problems, we can compute this number directly. We use the vector $\vec{z} = (2, 2)$ as the reference point in the hypervolume computation. All points that do not dominate the reference point are excluded from the hypervolume computation.

Parameter	MOEA value	Local search value
Stopping criterion	50,000 objective evaluations	30 generations
Population size	50	50
Crossover operator	SBX	SBX
Crossover probability	0.8	0.8
Mutation operator	Polynomial	Polynomial
Mutation probability	0.1	0.2
Archive size	400	–
Memetic operator probability	0.25	–
Meta-model locality parameter λ	–	1

Table 1: Parameters of the multiobjective algorithm

We run tests on the well-known set of ZDT functions [16]. Although we tested various types of meta-models (namely linear regression, support vector regression, and multilayer perceptrons), we present only the results of linear regression here¹. The parameters of LAMM-MMA are presented in Table 1. We used NSGA-II as the external multiobjective evolutionary algorithm.

In Table 2 we present the median number of objective function evaluations needed to attain the specified H_{ratio} over 20 runs for each of the configurations. NSGA-II is compared to ASM-MOMA and LAMM-MMA with linear regression as the meta-model.

We can see that the use of a global meta-model in ASM-MOMA generally greatly reduces the number of objective function evaluations needed to attain the specified H_{ratio} . The local meta-models of LAMM-MMA reduce this number further by another almost 10%. Although the difference may seem small, it can translate to reductions of run-time and great reductions of costs in practical tasks.

On ZDT1, ASM-MOMA reduced the number of evaluations needed to attain the $H_{ratio} = 0.95$ from more than 20,000 to 2,800. LAMM-MMA reduced this number further to 2,600. This means 7.4 times lower number for ASM-MOMA and almost 8 times lower number for LAMM-MMA. For $H_{ratio} = 0.99$ the reductions are not that large, however there is still reduction by almost 40% in the number of evaluations.

On ZDT2, the results for $H_{ratio} = 0.99$ show reductions by the factor of 6.3 for ASM-MOMA and 7.2 for LAMM-MMA. Again LAMM-MMA needed lower number of function evaluations than ASM-MOMA (by more than 10%).

H_{ratio}	0.5	0.75	0.9	0.95	0.99
ZDT1					
NSGA-II	5600	18600	19850	20750	21850
ASM-MOMA-LR	1500	2000	2400	2800	12750
LAMM-MMA-LR	1300	1750	2250	2600	13100
ZDT2					
NSGA-II	650	1650	3550	5050	7900
ASM-MOMA-LR	350	550	750	950	1250
LAMM-MMA-LR	350	450	600	850	1100
ZDT3					
NSGA-II	600	1250	4150	7250	–
ASM-MOMA-LR	300	500	700	800	1150
LAMM-MMA-LR	300	450	650	800	1050
ZDT6					
NSGA-II	7950	10200	13950	17700	28650
ASM-MOMA-LR	2750	5950	11100	15750	30500
LAMM-MMA-LR	2850	5850	10550	15350	29200

Table 2: Results of LAMM-MMA on the selected benchmark functions

On ZDT3, the original NSGA-II was not able to reach the $H_{ratio} = 0.99$ (there was a limit of 50,000 objective function evaluations), whereas both ASM-MOMA and LAMM-MMA attained this value after 1,150 and 1,050 function evaluation respectively. This would mean the reduction of more than 50 times. For the $H_{ratio} = 0.95$ both algorithms reached this value after 800 function evaluations, which is 9 times less than NSGA-II needed.

ZDT6 is the hardest problem for our approach and there is no reduction in the number of function evaluations, when NSGA-II is used as the external evolutionary algorithm and linear regression is used as the meta-model. In fact, the results are even slightly worse than those of the original NSGA-II. We have seen some slight reductions for different configurations, however, these were by far not as significant as those observed on other test problems.

¹The rest (and more) of the results were presented at GECCO'11 [17] and ICIC'11 [18] conferences, as well as submitted to the Neurocomputing journal [19].

7. Conclusions

We presented a multiobjective memetic algorithm with local meta-models. This algorithm helps to significantly reduce the number of function evaluations on most of the presented test problems. The comparison shows that local meta-models provide another 10% advantage over a single global meta-model. Although the advantage may seem small it might have great practical consequences and may lead to huge savings when applied to objective functions which are expensive to evaluate.

The disadvantage of the local meta-models compared to a single global one is the need to train the model multiple times in each generation, which adds another overhead. This must be considered, when the algorithm is applied in practice.

We also found a problem (ZDT6) where our approach did not work well. This problem provides motivation for further research. Another open question is the effect of the locality parameter λ on the convergence speed and the quality of obtained solutions.

References

- [1] K. Deb, S. Agrawal, A. Pratap, and T. Meyarivan, "A fast elitist non-dominated sorting genetic algorithm for multi-objective optimisation: NSGA-II," in *PPSN* (M. Schoenauer, K. Deb, G. Rudolph, X. Yao, E. Lutton, J. J. M. Guervós, and H.-P. Schwefel, eds.), vol. 1917 of *Lecture Notes in Computer Science*, pp. 849-858, Springer, 2000.
- [2] E. Zitzler, M. Laumanns, and L. Thiele, "SPEA2: Improving the strength pareto evolutionary algorithm," TIK Report 103, Computer Engineering and Networks Laboratory (TIK), ETH Zurich, Zurich, Switzerland, 2001.
- [3] E. Zitzler and S. Künzli, "Indicator-Based Selection in Multiobjective Search," in *Conference on Parallel Problem Solving from Nature (PPSN VIII)* (X. Yao *et al.*, eds.), Vol. 3242 of *LNCS*, pp. 832-842, Springer, 2004.
- [4] J. Bader and E. Zitzler, "HypE: An Algorithm for Fast Hypervolume-Based Many-Objective Optimization," TIK Report 286, Computer Engineering and Networks Laboratory (TIK), ETH Zurich, Nov. 2008.
- [5] A. Auger, J. Bader, D. Brockhoff, and E. Zitzler, "Theory of the Hypervolume Indicator: Optimal μ -Distributions and the Choice of the Reference Point," in *Foundations of Genetic Algorithms (FOGA 2009)*, 2009. workshop version.
- [6] J. D. Schaffer, "Multiple objective optimization with vector evaluated genetic algorithms," in *ICGA* (J. J. Grefenstette, ed.), pp. 93-100, Lawrence Erlbaum Associates, 1985.
- [7] E. J. Hughes, "Evolutionary many-objective optimisation: Many once or one many?," in *2005 IEEE Congress on Evolutionary Computation (CEC'2005)*, Vol. 1, (Edinburgh, Scotland), pp. 222-227, IEEE Service Center, September 2005.
- [8] I. Voutchkov and A. Keane, "Multiobjective optimization using surrogates," in *Presented on Adaptive Computing in Design and Manufacture (ACDM 06)*, 2006.
- [9] I. Loshchilov, M. Schoenauer, and M. Sebag, "A mono surrogate for multiobjective optimization," in *GECCO* (M. Pelikan and J. Branke, eds.), pp. 471-478, ACM, 2010.
- [10] I. Loshchilov, M. Schoenauer, and M. Sebag, "Dominance-based pareto-surrogate for multi-objective optimization," in *Simulated Evolution and Learning* (K. Deb, A. Bhattacharya, N. Chakraborti, P. Chakraborty, S. Das, J. Dutta, S. Gupta, A. Jain, V. Aggarwal, J. Branke, S. Louis, and K. Tan, eds.), Vol. 6457 of *Lecture Notes in Computer Science*, pp. 230-239, Springer Berlin / Heidelberg, 2010.
- [11] T. Joachims, "A support vector method for multivariate performance measures," in *Proceedings of the 22nd international conference on Machine learning, ICML '05*, (New York, NY, USA), pp. 377-384, ACM, 2005.
- [12] C. Georgopoulou and K. Giannakoglou, "Multiobjective metamodel-assisted memetic algorithms," *Multiobjective Memetic Algorithms*, pp. 153-181, 2009.
- [13] D. Lim, Y. Jin, Y.-S. Ong, and B. Sendhoff, "Generalizing surrogate-assisted evolutionary computation," *Trans. Evol. Comp.*, Vol. 14, pp. 329-355, June 2010.
- [14] A. Isaacs, T. Ray, and W. Smith, "An evolutionary algorithm with spatially distributed surrogates for multiobjective optimization," in *Proceedings of the 3rd Australian conference on Progress in artificial life, ACAL'07*, (Berlin, Heidelberg), pp. 257-268, Springer-Verlag, 2007.
- [15] M. Pilát and R. Neruda, "ASM-MOMA: Multiobjective memetic algorithm with aggregate surrogate model," in *Proceedings of the IEEE Con-*

- gress on Evolutionary Computation, CEC 2011*, pp. 1202-1208, IEEE, 2011.
- [16] E. Zitzler, K. Deb, and L. Thiele, "Comparison of Multiobjective Evolutionary Algorithms: Empirical Results," *Evolutionary Computation*, Vol. 8, No. 2, pp. 173-195, 2000.
- [17] M. Pilát and R. Neruda, "LMM-MMA: Multiobjective memetic algorithm with local aggregate meta-model," in *GECCO (Companion)* (N. Krasnoger and P. L. Lanzi, eds.), pp. 79-80, ACM, 2011.
- [18] M. Pilát and R. Neruda, "Local meta-models for ASM-MOMA," in *International Conference on Intelligent Computing, ICIC 2011*, Lecture Notes in Computer Science, Springer, 2011.
- [19] M. Pilát and R. Neruda, "Aggregate meta-models for evolutionary multiobjective and many-objective optimization," *Neurocomputing*, 2011. submitted.

A Portable Read-Copy-Update Algorithm

Post-Graduate Student:

MGR. ANDREJ PODZIMEK

Institute of Computer Science of the ASCR, v. v. i.
Pod Vodárenskou věží 2
182 07 Prague 8, CZ

podzimek@cs.cas.cz

Supervisor:

ING. LUBOMÍR BULEJ, PH.D.

Institute of Computer Science of the ASCR, v. v. i.
Pod Vodárenskou věží 2
182 07 Prague 8, CZ

bulej@cs.cas.cz

Field of Study:
Software Systems

Abstract

RCU is a synchronization mechanism that can increase concurrency in parallel algorithms, improving scalability in comparison to mutual exclusion. RCU provides asymmetric synchronization of concurrent writers and readers sharing a data structure. Unlike mutual exclusion primitives, RCU can avoid expensive memory operations on the most frequent code paths, boosting performance even on uniprocessors. Virtually all contemporary RCU implementations run in the Linux kernel and strongly depend on its internals.

Our work contributes a novel RCU algorithm based on easily portable foundations, not bound to any particular kernel architecture. We implemented and benchmarked our algorithm in the UTS kernel used by Solaris-based systems. We compared our RCU algorithm to a readers-writer lock and to a portable, but feature-constrained RCU algorithm called QRCU. Our benchmarks suggest that the novel algorithm can outperform both readers-writer locks and QRCU on current SMP systems.

1. RCU Essentials

Read-Copy-Update (RCU) is a means of communication among three types of entities: readers, writers and reclaimers [1].

Readers access a shared data structure without modifying it and can run in parallel with other readers and writers, guaranteed to never block when entering or leaving their critical sections. Most RCU implementations do not require the readers to use atomic instructions or other expensive operations.

Writers are a specific type of readers that can also modify the shared data. Writers cooperate with the RCU mechanism to provide other readers with an illusion of

data integrity, i.e. readers will not observe concurrent changes to the shared data during their critical sections. This is achieved by copying the shared data structure, making changes to the copy and finally replacing the pointer to the original data structure with a pointer to the new one atomically. As long as readers adhere to certain data access rules, they always observe a consistent state of the data structure. RCU neither supports nor constrains concurrency among writers; they have to synchronize their operations by means external to RCU.

Deallocation of old versions of protected data has to be postponed, so that readers accessing them can finish their work. The time needed for all potential readers to stop using the old data structure (no longer accessible to new emerging readers) is called a *grace period*. A moment when a potential reader does not access any data structure protected by RCU is called a *quiescent state*. A grace period elapses when all potential readers go through at least one quiescent state. Grace period detection is the key part of all RCU implementations.

Reclaimers deallocate outdated data structures that had been made inaccessible to readers. It is necessary to wait for at least one grace period before the deallocation can be done. Writers can use the RCU mechanism to block for at least one grace period, becoming reclaimers afterwards. Alternatively, they can proceed immediately, asking the RCU mechanism to perform the deallocation when appropriate. Our novel RCU algorithm supports both of these options.

2. The RCU Algorithm for UTS

The cornerstone RCU algorithms in the Linux kernel are strongly bound to features specific to Linux, such as timer interrupt handling on all processors. In the UTS kernel, timer interrupts are only handled by a subset of available processors, which may only include one processor on UMA machines [2]. This fundamental difference makes porting of the key Linux RCU algorithms to UTS or

other kernels technically infeasible. The design of our novel RCU algorithm strives to avoid technical dependencies related to one particular kernel.

The key idea behind our algorithm can be illustrated on a “toy” RCU algorithm presented by Paul McKenney [3]: Writers context-switch themselves to each available processor before they become reclaimers. Since readers run with disabled preemption, the writers’ behavior guarantees that at least one grace period must have elapsed. Presumably, this algorithm is unusable in practice. First, its SMP scalability would be extremely poor. Second, it does not support non-blocking writers and delayed batched resource reclamation.

Based on the principle mentioned above, we designed a more scalable algorithm where forced rescheduling is only used as the last resort when other means of grace period detection take too long to complete. Our novel algorithm differs from the trivial example above in a number of ways. First, all grace period detection requests are batched and handled centrally by one detector thread, which avoids the need to reschedule each writer on each processor on each request. Second, the central detector thread avoids forced migration in most cases, at the cost of slightly higher overhead on the readers’ side. Third, most of the advanced RCU features, such as asynchronous reclamation, are implemented.

A brief note on notable characteristics of our algorithm follows. Readers do not use any expensive atomic instructions. Readers only execute memory barriers when intensive grace period detection takes place; they never do so in the absence of grace period requests. Naturally occurring quiescent states (context switches, idle processors) are observed to reduce the grace period detection overhead even further. As long as all read-side critical sections take a bounded amount of time (which can be required and relied upon in a kernel environment), grace period duration is also bounded. Asynchronous reclamation requests are handled in efficient batches by the same processor on which they were created, so that a warm cache can be exploited.

3. Evaluation

To verify that our RCU algorithm for the UTS kernel leads to performance improvements typical for well-known RCU implementations, we created a benchmarking harness that performs a series of operations on a non-blocking hash table. This artificial workload simulates a kernel algorithm manipulating a data mapping under heavy stress. The same workload (sequences of hash table operations performed by multiple threads in

parallel) has been benchmarked with four different synchronization mechanisms protecting the hash table. We ran our benchmark on a variety of SPARCv9 and x86-64 SMP machines.

	511:1	127:1	31:1	7:1	1:1
RCUc	1	1.04	1.06	1.12	1.27
RCUs	1.03	1.23	1.48	2.23	5.24
QRCU	2.33	2.33	2.47	3.06	4.55
DRCU	2.86	4.21	8.95	N/A	N/A

Table 1: Relative average running time

Selected benchmark results (from an x86-64 machine with 8 processors) are shown in Table 1. Relative running times of our multithreaded workload are displayed, normalized so that the shortest measured result takes one time unit. Columns represent ratios between frequencies of read-only and read/write operations on the hash table. Rows represent synchronization mechanisms. RCUc and RCUs denote our algorithm with its synchronous and asynchronous reclamation handling API, respectively. QRCU denotes the feature-constrained RCU algorithm [4] ported for the sake of comparison. DRCU (“dummy RCU”) stands for an implementation of the RCU API using a plain readers-writer lock.

Since RCU is designed for read-mostly workloads, significant improvements over DRCU under high readers/writers ratios are not surprising. Interestingly, our novel algorithm performed relatively well even under low readers/writers ratios.

References

- [1] P. E. McKenney, *Exploiting Deferred Destruction: An Analysis of Read-Copy-Update Techniques in Operating System Kernels*. PhD thesis, OGI School of Science and Engineering at Oregon Health and Sciences University, 2004. http://www.rdrop.com/users/paulmck/RCU/RCU_dissertation.2004.07.14e1.pdf.
- [2] R. McDougall and J. Mauro, *Solaris internals: Solaris 10 and OpenSolaris kernel architecture*. Solaris Series, Sun Microsystems Press/Prentice Hall, 2007.
- [3] P. E. McKenney and J. Walpole, “What is RCU, fundamentally?.” <http://lwn.net/Articles/262464/>, December 2007.
- [4] P. E. McKenney, “Using Promela and Spin to verify parallel algorithms.” <http://lwn.net/Articles/243851/> August 2007.

Interoperabilita v českém zdravotnictví

doktorand:

ING. LIBOR SEIDL

Oddělení medicínské informatiky
Ústav informatiky AV ČR, v. v. i.
Pod Vodárenskou věží 2
182 07 Praha 8

seidl@euromise.cz

školitel:

ING. PETR HANZLÍČEK, PH.D.

Oddělení medicínské informatiky
Ústav informatiky AV ČR, v. v. i.
Pod Vodárenskou věží 2
182 07 Praha 8

hanzlicek@euromise.cz

obor studia:

Biomedicínská informatika

Abstrakt

Těžiště článku spočívá ve srovnání dvou používaných komunikačních standardů ve zdravotnictví: DASTA užívaná v češích, HL7 verze 2 ve světě. První část je vedle úvodu věnována popisu základních principů a obsahu obou standardů. Druhá část popisuje srovnávací metodologii, navrhuje zlepšení a hodnotí výsledek srovnání. Závěr je věnován úvaze o stavu užití standardů pro interoperabilitu systémů v českém zdravotnictví a výhledu do budoucna.

1. Úvod

Zdravotnictví je považováno za informačně nejnáročnější odvětví a bez důrazu na interoperabilitu (technickou, procesní, sémantickou) je výpočetní technika pro lékaře stále spíše psacím strojem a překážkou než efektivním nástrojem. Lepší nástroje přitom poskytují pohodlí, vyšší produktivitu, méně chyb, a zejména více času u pacienta. Informatizace léčebného procesu, interoperabilita mezi systémy a snaha o implementaci eHealth je výzvou našeho století a zároveň i možným lékem na neudržitelný demografický vývoj a rozpočtový schodek zdravotnictví v mnoha zemích. Problematika je diskutována jak v USA [1] [2], na úrovni Evropské komise [3] [4] [5], tak v České republice [6].

Vedle dopadu interoperabilních systémů na každodenní práci lékařů shledávám důležitou roli také v rovině vědeckovýzkumné. Domnívám se, že už z podstaty lékařovy zkušenosti panuje mezi nemocnicemi podvědomá rivalita v dosahovaných výsledcích léčby. Snaha o sebezlepšení automaticky indukuje experimentování s metodou léčby, byť stále v mantinelech uznávaných klinických postupů a pod rouškou lékařových mnohaletých zkušeností. Statistické vyhodnocení by pak mělo uzavírat kruh procesu sebezlepšování. Bohužel stávající klinické systémy ne-

umožňují efektivní využití zaznamenaných údajů a tak se zamýšlená statistická pozorování prodražují a nebo se raději vůbec nerealizují. Zavedením strukturovaného zdravotního záznamu a principů interoperability klinických systémů lze zpřístupnit data vložená do těchto systémů i pro jiné účely než opětovné čtení při další návštěvě pacienta. Možnost realizovat nízkonákladová statistická sledování vytvoří motivační potenciál pro sebezlepšení, souměřitelnost a konkurenceschopnost jednotlivých nemocnic. Zlevnění vědeckovýzkumných projektů je nasnadě. Projekt *Zlatokop* v IKEM [7] je toho jasným důkazem. Prostředkem interoperability jsou standardy pro výměnu dat mezi systémy. V Česku vyvinutou Dastu srovnáme s mezinárodním standardem HL7 verze 2.

2. DASTA

DASTA je zkratkou pro DATový STandard a běžně se používá i označení DS. Dasta byla z počátku vyvíjena Českou společností zdravotnické informatiky a vědeckých informací České lékařské společnosti Jana Evangelisty Purkyně (ČSZIVI ČLS JEP) [8]. Dnes se však již uvádí, že Národní číselník laboratorních položek (NČLP), Datový standard, program ČLP pro práci s číselníky laboratorních položek a nástroje pro práci s DS a pro předávání dat mezi IS jsou autorským dílem rozsáhlého kolektivu tvůrců z mnoha institucí, fakult, vědeckých ústavů a firem, celé dílo vzniklo za finanční podpory Ministerstva zdravotnictví ČR [9].

2.1. Historie

V roce 2003 byla vydána pracovní verze DS 03.00.01 a verze NČLP 02.05.01 (v červnu 2003). K 1. listopadu 2003 byl vydán finální tvar DS 03.01.01 společně s NČLP 02.06.01. Termín oficiálního vyhlášení platnosti těchto standardů byl od 1. ledna 2004 (prostřednictvím Věstníku MZ, částka 9, rok 2003). v dalších letech

2004 až 2006 bylo vydáno celkem 11 aktualizací DS3 a NČLP. v roce 2006 byl vývoj DS3 ukončen s tím, že v roce 2007 budou udržovány pouze bloky NZIS pro ÚZIS.

V prosinci roku 2006 byla na stránkách Ministerstva zdravotnictví České republiky uveřejněna verze 4 datového standardu, označovaná jako DS 04.01.01. Tento standard je závazný pro všechny uživatele Dasty od 1. ledna 2007 [9]. Přestože zápis dat je již od verze DS 02.01 realizován pomocí XML, DS 04.01.01 přináší revoluční technologii XML Schéma.

Pravděpodobně z důvodu existence závazku ČR v přístupové dohodě k EU o harmonizaci českých a Evropských norem byl někdy v letech 2009–2011 aktuální text standardu přesunut z adresního prostoru ministerstva zdravotnictví na stránky hlavního protagonisty - firmy Stapro (cílová doména přesměrování je `ciselniky.dasta.stapro.cz`). Dalším důvodem může být prostě zjednodušení procesu aktualizace textu standardu, na druhou stranu konsenzuální statut Dasty tak určitě utrpěl.

2.2. Datový soubor

Účelem Dasty bylo standardizovat automatizovaný přenos dat o pacientovi a souvisejících údajích. Standard ve všech verzích technicky představuje definici (tj. formát) datového souboru. Dasta definuje jednotlivé bloky (xml elementy) a jejich strukturu včetně vzájemného vnořování. Datový soubor pak obsahuje vždy hlavní blok *dasta*, na který jsou navázány další datové bloky obsahující přenášené informace. Datovým souborem je myšlen přímo soubor na disku, neboť název datového souboru je přesně vymezen jednou z kombinací:

"UTTXXXX.KKK"	soubory komprimované
"UTTYOOD.KKK"	soubory pro ÚZIS ČR
"UTTXXXX.xml"	soubory nekomprimované
"UTTYOOD.xml"	soubory pro ÚZIS ČR
"UTTXXXX.VVS"	soubory nekomprimované

Kde:

U	určuje typ urgentnosti: S=statim, R=rutina, T=technický nebo testovací,
TT	typ odesílajícího místa podle číselníku,
KKK	nástroj, kterým bylo zapakováno (arj/zip),
XXXX	řetězec sestavený z číslic a běžných písmen anglické abecedy,
YY	poslední dvojčíslí roku sledovaného období,
OO	kód období podle číselníku období (01=leden ... 12=prosinec, 4x=čtvrtletí),
D	pořadové číslo dávky za sledované období,
VV	verze datové struktury,
S	typ šifrování (N - nešifrováno).

Výsledná komunikace pak probíhá předáním datového souboru libovolnou (ale předem dohodnutou) elektronickou cestou – emailem, sdíleným diskovým/paměťovým prostorem, FTP, dříve také na FDD.

Dasta vůbec neřeší role komunikujících stran. Shodná datová struktura musí být použita v mnoha významech (vytvoření i smazání pacienta). Význam přenášené struktury je určen až v rámci každé instalace, předem zvoleným unikátním adresářem a dohodou (konfigurací) obou komunikujících stran.

2.3. Datové bloky

Datové bloky jsou základní strukturální entity datového souboru. Každý blok musí mít vždy své jméno, které je unikátní v rámci celého DS. Jméno datového bloku také určuje název XML elementu v datovém souboru. Popis každého datového bloku poskytuje informaci, které reálie se v bloku budou přenášet včetně určení, zda jsou povinné nebo volitelné. Přestože definice datového bloku je dostupná jak v DTD a ve vyšších verzích i v XML Schéma, popisná forma je definitoricky nadřazena.

Specifikace Dasty obsahuje u každého bloku stručný popis a použití bloku. Dále specifikace obsahuje tabulku, kde se určují typy informací, které lze do datového bloku uložit. Znovupoužitelnost datových struktur leží plně na bedrech vývojářů, což se ne vždy podaří [10]. Jako příklad definice bloku uvedu popis hlavního datového bloku s názvem *dasta* (viz obrázek 1).

***dasta**

Hlavní blok. Kořen grafu. Varianta pro DS4.

Váže se k celému odesílanému souboru všech odesílatelů určenému pro jednoho příjemce.

Popis struktury bloku v obecném tvaru je k dispozici v odkazu [popis struktury bloků a souborů DS](#).

Změny realizované od vydání DS3 jsou v seznamu [změny v popisu struktury bloků a souborů DS3](#).

Změny realizované od vydání DS4 jsou v seznamu [změny v popisu struktury bloků a souborů DS4](#).

(distribováno od verze 4.01.01)

kód	T	D	V	plný název	hodnota	podmínky, pokyny, poznámky	změny
id_soubor	a	-40	1	jednoznačná vnitřní identifikace souboru v rámci firmy a jejího programu nebo informačního systému	text předepsané konstrukce	pokyny: 1. povinný 2. viz id_soubor - pokyny	
verze_ds	a	8	1	verze datové struktury	[V_DS] #	pokyny: 1. ve formátu xx.xx.xx, viz verze datového standardu 3. viz verze_ds - pokyny poznámky: 1. například: "03.02.01" 2. viz verze_ds - poznámky	
verze_nclp	a	8	1	verze používaného NCLP	[V_NCLP] #!	pokyny: 1. ve formátu xx.xx.xx 2. není-li NCLP vůbec využíván, zadává se nejvyšší verze 2.00.00 3. viz verze_nclp - pokyny poznámky: například: "02.07.01"	
bin_priloha	a	1	1	binární datové bloky	T, B viz seznam hodnot	pokyny: viz priloha poznámky: nejčastěji bude = T	
ur	a	1	1	určení, typ přenášených dat (v případě patientských dat	R, S, U, V, B, C, H, T	pokyny: 1. viz blok is a též viz název	

Obrázek 1: Ukázka definice bloku "dasta".

Popis bloků využívá možnost HTML a jednotlivé definice a reference na číselníky jsou realizovány hypertextovým odkazem, což zrychluje dohledání potřebné informace. Sloupce mají následující význam:

kód	identifikátor pro potřeby XML,
T	XML typ: a - atribut, e - element, d - data,
D	délka položky,
V	výskyt/multiplicita (*, ?, +, počet),
hodnota	výčet hodnot, odkaz na tabulku nebo nevyplněno,

Aktuální verze Dasta je připravena pojmout a přenést následující údaje: informace obálky datové zprávy (identifikace odesílatele, adresáta), informace o pacientovi (demografické údaje, údaje o platbě a pojišťovně, údaje pro NZIS, diagnózy, očkování, léky vydané, pracovní neschopnosti, nestrukturovaná anamnéza), klinické události, výkaznictví do UZIS, laboratorní hodnoty, hodnoty hygieny a epidemiologie a vykázané výkony.

Za poznámku stojí také novinka v DS 04 – firemní bloky. Firemním blokem je myšlen speciálně vyhrazený xml element s konkrétním jménem, jehož obsah však již dále není nijak specifikován. Bloky od různých výrobců informačních systémů se liší v použitém jmenném prostoru (XML namespace). Podle vyjádření autorů by se obsah těchto bloků měl evolucionárně vyprofilovat do nevhodnější podoby, která se časem stane součástí standardu Dasta.

2.4. Číselníky

Žádný standard se neobejde bez vlastních číselníků. Cílem každého standardu je formalizovat určitou oblast a právě číselníky jsou přímým nástrojem pro klasifikaci možných stavů popisovaných veličin.

Číselníkem je podle definice Dasty uspořádaný soubor (obvykle uniformně dlouhých) hodnot. Ke každé hodnotě vždy přísluší krátký a dlouhý textový popis. Těchto tzv. jednoduchých číselníků Dasta obsahuje celkem 88. Jako příklad uvádím číselník NCMPATML (antimikrobiální látky):

Číselník NCMPATML

Číselník	NCMPATML	KLIC	N32	N55	PORADÍ
Název	Číselník antimikrobiálních látek	AMC	amoxicilin klavulanát	amoxicilin klavulanát	001000
Zdroj	Číselníky NČLP	AMF	amfotericin B	amfotericin B	002000
Aktualizace	30.12.2006 0:16:40	AMI	amikacin	amikacin	003000
Klíč(e)	KLIC	AMP	ampicilin	ampicilin	004000
Počet vět	104	AMS	ampicilin sulbaktam	ampicilin sulbaktam	005000
Sada	200710	AMX	amoxicilin	amoxicilin	006000
Sada změna	200710	AZI	azitromycin	azitromycin	007000
Verze NČLP	02.17.01	AZL	azlocilin	azlocilin	008000
Verze DS	04.01.01	AZT	aztreonam	aztreonam	009000
Platnost od	1.1.2007	BAC	bacitracin	bacitracin	010000
Platnost do		BIF	bifonazol	bifonazol	011000
		CDR	cefadroxil	cefadroxil	012000
		CFC	cefaklor	cefaklor	013000
		CIP	ciprofloxacin	ciprofloxacin	014000
		CLA	klaritromycin	klaritromycin	015000
		CLI	klindamycin	klindamycin	016000
		CLT	cefalotin	cefalotin	017000

Obrázek 2: Ukázka definice číselníku “antimikrobiální látky”.

Mimo tyto číselníky používané přímo Dastou jsou na stránkách [9] i číselníky používané při výkazech do NZIS. Těchto číselníků je cca 348. Zcela odděleně je pak číselník NČLP, který se svojí rozsáhlostí a komplexitou vyrovnává světově uznávaným nomenklaturám LOINC nebo ICD10.

3. HL7 Verze 2

Komunikační standard HL7 verze 2 začal vznikat v roce 1987. Zcela poplatně době byla primárně řešena potřeba výměny dat, tedy zejména forma zápisu a struktura dat. Jako logické řešení se nabízel definování datových zpráv formou textového dokumentu. Každá zpráva měla být uložena v samostatném souboru, každý řádek obsahuje samostatný segment (typ je určen třemi písmeny na začátku řádku). Každý segment obsahuje položky (fields), které jsou navzájem odděleny znakem „|“. Každá položka je určeného datového typu. Datový typ předurčuje počet, pořadí a význam komponent obvykle oddělených znakem „^“. HL7 zprávy nevycházejí z žádného referenčního datového modelu, relativně velké znovupoužitelnosti kódu je však dosaženo opakováním stejného segmentu v mnoha zprávách a užitím komplexnějších datových typů vytvořených speciálně pro výměnu informací ve zdravotnictví (ČSN ISO 21090:2011). Příklad HL7 zprávy označené jako *ORU ^ R01* [11].

```
MSH|^~\&||GA00||VAERS PROCES|20010331||ORU^R01...
PID||1234^^^^SR^123412^^^^LR^00725^^^^MR||Doe^J...
```

```
NK1|1|Jones^Jane^Lee^^RN|VAB^Vaccine administere ...
NK1|2|Jones^Jane^Lee^^RN|FVP^Form completed by ...
ORC|CN||||||||1234567^Welby^Marcus^J^Jr^Dr ...
OBR|1||||CDC VAERS-1 (FDA) Report|||20010316|
...
```

První tři znaky každého řádku (segmentu) označují identifikátor segmentu, v tomto případě značí: Hlavička zprávy (MSH), identifikace pacienta (PID), přidružené osoby k pacientovi (Next of Kin - NK1), obecné informace o objednavce (Order Commons – ORC), požadavek na pozorování (Observation Request – OBR). Celý standard HL7 verze 2 je rozdělen do následujících kapitol:

- 1: Introduction (Úvod)
- 2: Control (Řízení toku informací)
- 2A: Control - Data Types (Datové typy)
- 2B: Control - Conformance (Kompatibilita)
- 3: Patient Administration (Administrace pacienta)
- 4: Order Entry (Laboratorní žádanky)
- 5: Query (Dotazy, vyhledávání)
- 6: Financial Management (Agenda samoplátců)
- 7: Observation Reporting (Zprávy o měřených hodnotách)
- 8: Master Files (Číselníkový server)
- 9: Medical Records/Information Mgmt. (Řízení toku dokumentů)
- 10: Scheduling (Plánování a objednávky)
- 11: Patient Referral (Žádanka o vyšetření)

- 12: Patient Care (Sdílená péče o pacienta)
- 13: Clinical Laboratory Automation (Laboratorní výsledky)
- 14: Application Management (Řízení aplikací)
- 15: Personnel Management (Personalistika)
- 16: eClaims (Výkaznictví pojišťovně)
- 17: Materials Management (Skladové hospodářství)

Od třetí kapitoly každá kapitola obsahuje přes 100 stran definic zpráv (povinností a opakování segmentů a polí, tabulkových výčtů hodnot) a ke každému poli je explicitně uveden význam. Takto (zdlouhavou) specifikací obsahu zpráv je suplována absence referenčního modelu a vzniká tak nepříjemná možnost „přiohnout“ význam segmentu v konkrétní zprávě. Ukázka definice čtvrtého pole ze segmentu OBR je na obrázku 3.

4.5.3.4 OBR-4 Universal Service Identifier (CWE) 00238

```
Components: <Identifier (ST)> ^ <Text (ST)> ^ <Name of Coding System (ID)> ^ <Alternate Identifier (ST)> ^
<Alternate Text (ST)> ^ <Name of Alternate Coding System (ID)> ^ <Coding System Version ID (ST)> ^
<Alternate Coding System Version ID (ST)> ^ <Original Text (ST)>
```

Definition: This field contains the identifier code for the requested observation/test/battery. This can be based on local and/or "universal" codes. We recommend the "universal" procedure identifier. The structure of this CE data type is described in the control section.

Obrázek 3: Ukázka definice 4. položky v segmentu OBR.

HL7 verze 2 určuje role komunikujících stran pomocí popisu spouštěcí události (tzv. *Trigger Event*), která zapříčinila vznik zprávy. Identifikátor spouštěcí události nalezneme v záhlaví zprávy (segment *MSH*) na deváté pozici, v druhé komponentě (v našem příkladu tedy *ROI*). Několik spouštěcích událostí může vyvolat shodný typ zprávy, obdobně jako u Dasta, kde je stejná struktura souboru použita k více účelům. Způsob použití standardu HL7 v2 je ale díky výčtu spouštěcích událostí daleko více predikovatelný, než v případě Dasta, kde význam datového souboru vzniká až dohodou mezi komunikujícími stranami a samotná Dasta toto neřeší.

4. Iniciativa IHE

Integrating the Healthcare Enterprise (IHE) je celosvětová iniciativa zdravotnických profesionálů, výrobců software a poskytovatelů péče [13] [14] [15]. Vzhledem k tomu, že řešení konkrétního úkolu přenosu dat (např. sdílení admin. údajů o pacientovi, předávání RTG snímků apod.) dnes může být realizováno několika způsoby a přesto podle existujících standardů, IHE se snaží o zakotvení doporučených postupů realizace interoperability systémů v praxi. Přílišná volnost výrobců software při volbě způsobu komunikace vede k nekompatibilním technologickým řešením, byť podle existujících standardů.

Vzhledem k tomu, že se IHE soustřeďuje na konkrétní realizace komunikace, je možné pro tyto úlohy otestovat kompatibilitu různých produktů. IHE pořádá setkání výrobců software pod názvem *Connectathon*, kde se výrobci snaží dopilovat komunikaci s jinými produkty

a pak obstat v certifikaci IHE. Výsledky těchto setkání jsou dostupné v databázi kompatibilních produktů, takže se zdravotnické zařízení dodržující doporučení IHE může předem ujistit, zda-li se zamýšlený nákup konkrétního software neprodraží v rámci začlenění do podnikové architektury.

IHE zveřejňuje svoje specifikace v tzv. profilech. Název *profil* vychází z terminologie použitých komunikačních standardů, kde se jakékoliv zpřesnění nad rámec obecné specifikace nazývá lokálním profilem. IHE profily definují konkrétní úlohy sdílení dat, určují vhodný standard a dále popisují způsob užití standardu.

Nejnázornějším příkladem je asi úkol synchronizace času v rámci zdravotnického zařízení. Přestože mnoho čtenářů bez okolku navrhne protokol NTP [16], v praxi se objevuje vedle synchronizace na úrovni pracovní stanice také synchronizace času na úrovni klientské aplikace pracující nad společnou databází MySQL v režimu client-server. IHE profil *Consistent Time Integration* [17] proto doporučuje jednotný postup. Pokud je požadavek na jednotný čas, použít NTP v případě, kdy je centrální časový server k dispozici, v ostatních případech použít SNTP [18] (které je podporováno i v NTPd).

4.1. IHE PAM Profil

Abychom mohli věrohodně porovnat standardy DASTA a HL7 verze 2 ve stejné situaci, musíme ke standardu HL7 přibrat ještě specifikaci použití (IHE profil) v případech, ve kterých se běžně Dasta používá.

Patient Administration Management (PAM) je profil z domény “IHE IT Infrastructure”. Profil popisuje, jak mají aplikace mezi sebou sdílet demografické údaje o pacientech za použití HL7 verze 2. Profil navrhuje dva topologicky odlišné způsoby administrace: centrální registr nebo architekturu rovnocenných lokálních registrů.

5. Srovnání DASTA a HL7

Objektivní srovnání dostupných komunikačních standardů je důležité nejen pro budoucí podporu rozvoje DASTA ze strany MZ ČR, ale zejména pro směřování vývoje českých nemocničních informačních systémů. Prvním krokem při zavádění interoperability je zajištění přenosu patientských údajů mezi systémy, protože vedle vlastních informací o pacientech se tak distribuují i jednotná identifikace pacienta, nevznikají duplicita a zamezí se pozdějšímu ručnímu slučování záznamů. Proto jsem se společně s kolegy z EuroMISE centra zaměřil na srovnání DASTA a HL7 verze 2 (IHE PAM profil) v úloze přenosu patientských dat.

Pro srovnání jsem využil “Framework” publikovaný předsedou sdružení HL7 Finsko (Juhoa Mykkänen) [19]. Tento hodnotící systém obsahuje celkem 9 formulářů. Každý formulář se zaměřuje na specifické téma definice standardu:

- Form. 1: Základní informace a účel standardu,
- Form. 2: Obsah a sémantika,
- Form. 3: Funkcionalita a interakce,
- Form. 4: Aplikační infrastruktura,
- Form. 5: Technické aspekty,
- Form. 6: Flexibilita standardu,
- Form. 7: Vyspělost, použitelnost, oficiální statut,
- Form. 8: Životní cyklus systému/aplikací,
- Form. 9: Specifické možnosti rozšíření.

Framework vyžaduje vyhodnocení formulářů v pořadí 1, 9, 2, 3, 4, 5, 6, 7 a 8, přičemž formuláře 1 a 9 mohou být zcela diskvalifikující - používají se jako hrubé síto. Každý formulář obsahuje několik otázek, které by měly být vzaty v úvahu před implementací konkrétního úkolu. Každá otázka se nejprve hodnotí z hlediska důležitosti otázky (w_i) na stupnici 0-3 (0: není důležitým faktorem, 1: žádoucí, 2: velmi žádoucí, 3: povinné). Následně je na otázku odpovězeno z pohledu hodnoceného standardu j na stupnici -3 až +3 (-3: standard odporuje požadavku, 0: standard nespecifikuje, +1: standard může požadavek podporovat za pomoci rozšíření, +2: požadavek je částečně podporován, +3: požadavek je plně podporován), hodnotu označme s_{ij} . Po vyhodnocení celého formuláře můžeme vypočítat celkové skóre standardu j za tento formulář:

$$sc_j = \sum (w_i * s_{ij}) \quad (1)$$

Čím vyšší skóre standard obdrží, tím vhodnější by měl být. Jak jsem v průběhu hodnocení zjistil, maximální dosažitelné skóre z různých formulářů je závislé na počtu otázek v jednotlivých formulářích. V celkovém skóre pak rozsahem větší formuláře neoprávněně nabývají na závažnosti. Proto jsem navrhnul opravu váhy otázky w_{ij} počtem otázek ve formuláři, $w'_i = w_i/n$ a tedy i celkové skóre standardu: $sc'_j = sc_j/n$.

5.1. Výsledek

Provedl jsem hodnocení standardu DASTA a HL7 v2 v IHE PAM Profilu pro účely výměny patientských dat mezi systémy. Dosažené hodnocení v jednotlivých formulářích vč. oprav na počet otázek formuláře je uvedeno v tabulce 1, nejvyšší hodnota v každém sloupci je tučně zvýrazněna.

Formulář	Poč. otázek	$\sum w'_i$	DASTA		IHE PAM	
			sc_1	sc'_1	sc_2	sc'_2
1: Základní informace a účel standardu	30	2,9	58	1,9	126	4,2
2: Obsah a sémantika	29	1,8	116	4,0	135	4,7
3: Funkcionalita a interakce	27	1,5	41	1,5	96	3,6
4: Aplikační infrastruktura	14	1,4	16	1,1	53	3,8
5: Technické aspekty	12	0,8	17	1,4	12	1,0
6: Flexibilita standardu	4	1,5	5	1,3	17	4,3
7: Vyspělost, použitelnost, oficiální statut	9	0,9	17	1,9	20	2,2
8: Životní cyklus systému/aplikací	9	1,2	16	1,8	15	1,7
9: Specifické možnosti rozšíření	17	0,9	22	1,3	42	2,5
Celkem:	151		308	16,2	516	27,8

Tabulka 1: Výsledek hodnocení v jednotlivých formulářích.

5.2. Diskuse

Chceme-li zhodnotit významnost navržené opravy, musíme srovnat počty otázek ve formulářích a součet hodnocení relevantnosti otázek v jednotlivých formulářích. Zatímco první tři nejrozsáhlejší formuláře č. 1, 2, 3 obdržely i nejvyšší součty relevantnosti, formulář č. 6 (Flexibilita) se posunul k významnějším, naopak formulář č. 9 (Specifické možnosti rozšíření) na významnosti ztratil. Změna v pořadí odpovídá realitě pro náš případ, neboť jsem hodnotil standardy pro zcela konkrétní případ a tak je důležitá flexibilita, nikoliv nějaké možnosti rozšíření, která při implementaci spíše překážejí. Tomu odpovídá i hodnocení standardu HL7 ve flexibilitě, kdy $sc_2 = 17$ byla třetí nejmenší hodnota, ale po opravě na počet otázek se jedná o druhý největší příspěvek ($sc'_2 = 4.3$) do celkového skóre.

Srovnáme-li poměr celkového skóre, vidíme kolikrát je DASTA lepší než HL7 v2. Zároveň vidíme, že v našem případě oprava neměla velký vliv na výkonnost standardů v hodnocení.

$$sc_1/sc_2 = 0,60 \quad ; \quad sc'_1/sc'_2 = 0,58 \quad (2)$$

Malý vliv opravy na výkonnost standardu je pravděpodobně způsoben aplikací hodnotícího rámce na případ velmi podobný tomu, za jakým byl rámec vytvářen. Matematicky se tento fakt odráží ve velmi podobném pořadí formulářů řazeno podle počtu otázek i podle normované relevantnosti.

6. Závěr

Hodnocení prokázalo, že Dasta nedosahuje kvalit standardu HL7 v2 ani v té nejběžnější situaci předávání patientských dat.

Po informační stránce jsou standardy prakticky nesrovnatelné. HL7 verze 2 v každé kapitole na úvod popíše očekávané situace a nastíní problémy k řešení. Čtenář tak dostane nejen představu o myšlenkových pochodech autorů kapitoly, ale zároveň srovnáním s českou praxí velmi rychle odhalí další (zatím nevyužité) možnosti v oboru. Dále jsou specifikovány jednotlivé spouštěcí události reálného světa. Každá spouštěcí událost má svůj unikátní kód (např. A01, S04) a pokud nastane, zapřičiní přenos konkrétního typu zprávy s definovanou strukturou segmentů. Protože každá kapitola je popisována specifické oblasti, jsou zde definovány i nové segmenty, které obsahují potřebná pole pro přenos dat. Velmi rychle čtenář získává představu o tom, co může být přenášeno, za jakých podmínek, v jakých situacích a jaká je souslednost zpráv.

Oproti tomu DASTA se vždy omezuje na popis struktury dat, přičemž povinnost, násobnost, resp. nepoužití konkrétního údaje nebo bloku vyplývá z logiky řešeného případu. Stejně tak spouštěcí událost (a tedy i způsob zpracování zprávy) musí přijímající strana dovodit, případně musí být explicitně dohodnuto mezi komunikujícími stranami. Pozorný čtenář zde možná uvidí příměr k výměně zpráv o změnách stavu v protikladu se zasíláním dokumentů konstatujících finální stav. A oprávněně. V českém prostředí všeobjímajících monolitických nemocničních informačních systémů (NIS) možná ani neexistuje potřeba rozesílat změny stavů, neboť NIS sám zajistí potřebnou funkcionalitu. Pro uživatele NISu je pak dostatečné exportovat pouze finální stav do sousedního systému.

Srovnání standardů bylo publikováno ve sborníku konference EFMI STC 2011 a prezentováno kolegou Nagym ve Slovinském Laško jako součást výzkumného projektu CBI ([20]).

6.1. Výhled do budoucna

Zastávám názor, že česká laická, lékařská i informační veřejnost je ve vztahu k medicínské informatice a eHealth nedostatečně informována. Příčinu spatřuji v časté změně na postu Ministra zdravotnictví, v absenci dlouhodobě sledované strategie implementace eHealth na MZČR, v personálním podstavu odboru informatiky MZČR a v technologických limitech dnes používaných monolitických informačních systémů, důkazem budiž změřená výkonnost Dasty. Mezi další příčiny patří všeobecná česká vlastnost ignorování zahraničních technologických trendů, nedostatečná participace v mezinárodních standardizačních institucích a faktická nefunkčnost sdružení eHealthForum. Z všeobecné neznalosti a s ohledem na existenci několika odstrašujících pokusů pak plyne nezájem nebo dokonce averze lékařů k inovacím, neochota dodavatelů investovat do inovativních technologií eHealth, ignorování technologických výzev ze strany VZP, tápání MZČR v implementaci eHealth a všeobecný technologický věhlas IZIP|EZK založený spíše na lobbismu, než na dosažených technologických metách.

Domnívám se, že zavádění eHealth v ČR bude probíhat postupně a v tempu úměrnému schopnostem nabídky a poptávky po nových technologiích. Důkazem je současná antipatie lékařů k eHealth ruku v ruce s malou angažovaností výrobců zdravotnického software (viz každý seminář ČNFcH). Na straně poptávky musí nemocnice, lékaři i sestry rozpoznat přínosy eHealth a dospět k ochotě investovat do inovací. Na straně nabídky musí stát dostatečné technologické znalosti a hmatatelná konkurence, aby inovace nebyly pouhým předraženým reklamním kabátkem. Technologický roz-

voj tuzemských dodavatelů informačních systémů je úměrný dostupnému kapitálu, agresivitě konkurenčního prostředí a dostupností praktických zkušeností s technologiemi. Trh s informačními systémy je momentálně díky monolitickým softwarovým řešením, důsledkem výhodného data-lockinu a díky akvizicím v minulých letech prakticky nehybný a uzavřený v české kotlině. Situaci žel nepřispívá ani z pohledu medicínské informatiky diletantský přístup firmy IZIP.

Literatura

- [1] U.S. Department of Health and Human Services, Office of the National Coordinator for Health Information Technology Program. *HITECH Programs* [online]. 1/27/2011 [cit. 2011-7-24]. Dostupné na <http://healthit.hhs.gov/portal/server.pt?open=512&objID=1487&mode=2>.
- [2] U.S. Department of Health and Human Services, Centers for Medicare & Medicaid Services. *42 CFR Parts 412, 413, 422 et al.; Medicare and Medicaid Programs; Electronic Health Record Incentive Program; Final Rule* [online]. July 28, 2010. Strana 44370–44380 [strana v pdf: 58–68, cit. 2011-7-24]. Dostupné na <http://edocket.access.gpo.gov/2010/pdf/2010-17207.pdf>.
- [3] European Commission. *A Digital Agenda for Europe* [online]. Brussels, 26.8.2010. [cit. 2011-7-24]. Dostupné na <http://eur-lex.europa.eu/LexUriServ/LexUriServ.do?uri=COM:2010:0245:FIN:EN:PDF>.
- [4] European Commission. *A Digital Agenda for Europe, Pillar II: Interoperability and Standards* [online]. [cit. 2011-7-24]. Dostupné na http://ec.europa.eu/information_society/newsroom/cf/pillar.cfm?pillar_id=44.
- [5] European Commission. *EU-US cooperation on eHealth, workshop minutes* [online]. Brussels, 14.4.2011. [cit. 2011-7-24]. Dostupné na http://ec.europa.eu/information_society/activities/health/docs/events/2011/eu-us_ehealth_wkshp140411/eu-us_coop_ehealth-meet140411-minutes.pdf.
- [6] České národní fórum pro eHealth, ICT Unie. *Národní plán rozvoje eHealth* [online]. 16.8.2010. [cit. 2011-7-24]. Dostupné na http://www.ictu.cz/fileadmin/docs/Akce_Spis/Pra_covni_skupiny/ehealth/ICTU-brozura-eHealth-10-08-16-osvit.pdf.
- [7] D. Hačkajlo. *Zlatokop v IKEM* [online]. 11.10.2005. [cit. 2011-7-26]. Dostupné na <http://www.dbsvet.cz/view.php?cisloclanku=2005101101>.
- [8] Česká společnost zdravotnické informatiky a vědeckých informací *ČSZIVI-Datové standardy* [online, cit. 2011-7-27]. Dostupné na <http://www.medinfo.cz/oblasti/standardy>.
- [9] Ministerstvo zdravotnictví ČR *Datový standard MZ ČR DS 04.06.05* [online]. 27.6.2011. [cit. 2011-7-27]. Dostupné na <http://ciselniky.dasta.mzcr.cz/hypertext>.
- [10] Ministerstvo zdravotnictví ČR *Datový standard MZ ČR DS 04.06.05, *text - obsah textového bloku* [online]. 27.6.2011. [cit. 2011-7-27]. Dostupné na <http://ciselniky.dasta.stapro.cz/hypertext/201130/hypertext/DSACS.htm>.
- [11] DT2 Software, L.L.C. *Sample HL7 Immunization Messages* [online]. 1.12.2009. [cit. 2011-7-28]. Dostupné na <http://www.dt7.com/cdc/sampmsgs.html>.
- [12] Health Level Seven, Inc. *Sample HL7 Immunization Messages* [online]. 1.12.2009. [cit. 2011-7-28]. Dostupné na <http://www.dt7.com/cdc/sampmsgs.html>.
- [13] Integrating the Healthcercer Enterprise. *Welcome to Integrating the Healthcare Enterprise* [online]. 2011. [cit. 2011-7-30]. Dostupné na <http://www.ihe.net>.
- [14] IHE-Europe. *National Initiatives | IHE in Europe* [online]. 1.12.2009. [cit. 2011-7-30]. Dostupné na <http://www.ihe-europe.net/node/55>.
- [15] IHE Australia. *Homepage* [online]. June 2011. [cit. 2011-7-30]. Dostupné na <http://www.ihe.net.au>.
- [16] Network Working Group. *RFC 1305 - Network Time Protocol (Version 3) Specification, Impl* [online]. March 1992. [cit. 2011-7-30]. Dostupné na <http://www.faqs.org/rfcs/rfc1305.html>.
- [17] Integrating the Healthcare Enterprise. *IT Infrastructure Technical Framework, Vol. 2a, Final Text*, pp. 13 [online]. August 10, 2010. [cit. 2011-7-30]. Dostupné na http://www.ihe.net/TechnicalFramework/upload/IHE_ITL_TF_Rev7-0_Vol2a_FT_2010-08-10.pdf.
- [18] Network Working Group. *RFC 4330 - Simple Network Time Protocol (SNTP) Version 4 for IPv4, IPv6 and OSI* [online]. January 2006. [cit. 2011-7-30]. Dostupné na <http://tools.ietf.org/html/rfc4330>.
- [19] J.A. Mykkänen and M.P. Tuomainen, *An evaluation and selection framework for interoperability standards*. Information and Software Technology 50, 176–197, 2008.
- [20] M. Nagy, P. Preckova, L. Seidl, and J. Zvarova, *Challenges of interoperability using HL7 v3 in Czech healthcare*. Studies in Health Technology and Informatics. 155, pp. 122-128, 2010.

Stochastic Approaches to Identification Process in Forensic Medicine and Criminalistics

Post-Graduate Student:

MGR. DALIBOR SLOVÁK

Department of Medical Informatics
Institute of Computer Science of the ASCR, v. v. i.
Pod Vodárenskou věží 2
182 07 Prague 8, CZ

slovak@euromise.cz

Supervisor:

PROF. RNDR. JANA ZVÁROVÁ, DRSC.

Department of Medical Informatics
Institute of Computer Science of the ASCR, v. v. i.
Pod Vodárenskou věží 2
182 07 Prague 8, CZ

zvarova@euromise.cz

Field of Study:
Biomedical informatics

This work was supported by The Centre of Biomedical Informatics and MŠMT ČR project 1M06014.

Abstract

In this paper we study an identification of culprit and assesment of evidence against him. We define a simple model called the island problem and we derive the weight-of-evidence formula in its basic form. We find how we can deal with uncertainty about basic parameters of model, like size of population. We investigate possibility of inclusion of relatedness and subpopulation structure into model through beta-binomial formula, we enlarge DNA mixtures of DNA and at the close we present brief overview about DNA databases.

1. Introduction

Technological progress that allows the use of DNA has caused a revolution in criminology. It helps convict the perpetrators of those crimes that once appeared irresolvable and also helps prove the innocence who have already been convicted. DNA analysis is now accepted by the broad public as a completely standard procedure, which reliably convicts the offender. Here, however, hides one of the main problems that results from using DNA, for even DNA evidence is not foolproof.

Several possibilities keep DNA from being completely reliable: for example there may be a false location of the trace (more specifically, the offender may have discarded a cigarette butt which had previously been smoked by someone else); the wrong take of biological samples or damage to the samples could have occurred; or there may have been secondary transfer of biological material. However, mathematicians do not deal with any of these things. Rather, they are faced with the following task: if all of the above options are excluded, what is the probability that a particular offender is a detained person,

given that the perpetrator's DNA and the DNA of the suspect are available?

In forensic practice, genetic profiles consisting of the short tandem repeat (STR) polymorphisms are currently used. The number of polymorphisms varies from country to country, with the smallest being seven used in Germany and a maximum of sixteen used in the Czech Republic. The probability of correct identification depends on the number of comparisons of polymorphisms (or loci where studied polymorphisms lie) and their genetic variability. The more we investigate loci and the greater the variability between individual loci, the smaller the probability that the other person will have the same configuration (and therefore the same genetic profile). Due to the quality of biological material and its amount it is not always possible to investigate all of the polymorphisms and very often genetic profiles contain fewer loci than is necessary to uniquely identify them.

In the following text we will assume that we examine only one locus. Assuming independence of loci, generalization to a larger number of loci can be performed using product rule (i.e. multiplying the individual marginal probabilities).

2. Formalization

Denotation

- E - evidence or information about the crime (i.e. the circumstances, witness testimonies, crime scene evidence, etc.)
- G - an event at which the suspect is guilty
- I - an event at which the suspect is innocent
- C_i - an event at which the culprit is a person i
- \mathcal{I} - the population of alternative suspects.

Our goal is to determine the conditional probability of $P(G|E)$ that, given circumstances E , the suspect is truly the culprit of the investigated crime. According to Bayes theorem

$$P(G|E) = \frac{P(E|G)P(G)}{P(E|G)P(G) + P(E|I)P(I)}. \quad (1)$$

However, the expression $P(E|I)$ cannot be counted directly. The suspect is innocent if and only if there exists an index $i \in \mathcal{I}$ in which the event C_i occurs. Then the event I is equivalent to the event $\cup_{i \in \mathcal{I}} C_i$ and thanks to the disjunction of events C_i holds:

$$P(I) = P(\cup_{i \in \mathcal{I}} C_i) = \sum_{i \in \mathcal{I}} P(C_i).$$

Thus

$$\begin{aligned} P(E|I)P(I) &= P(E | \cup_{i \in \mathcal{I}} C_i) P(\cup_{i \in \mathcal{I}} C_i) = \\ &= \frac{P(E \cap (\cup_{i \in \mathcal{I}} C_i))}{P(\cup_{i \in \mathcal{I}} C_i)} P(\cup_{i \in \mathcal{I}} C_i) = \\ &= P(\cup_{i \in \mathcal{I}} (E \cap C_i)) = \\ &= \sum_{i \in \mathcal{I}} P(E \cap C_i) = \\ &= \sum_{i \in \mathcal{I}} P(E|C_i)P(C_i). \end{aligned}$$

Define **likelihood ratio**

$$R_i = \frac{P(E|C_i)}{P(E|G)} \quad (2)$$

which expresses how many times the probability of evidence E is greater under the condition that the culprit is a person i than under the condition that the culprit is the suspect. Further define **likelihood weights**

$$w_i = \frac{P(C_i)}{P(G)}$$

which expresses how many times the prior probability of committing a crime by a person i is greater than the prior probability of committing a crime by the suspect.

Then

$$P(G|E) = \frac{1}{1 + \sum_{i \in \mathcal{I}} w_i R_i}. \quad (3)$$

The formula (3) is usually called **the weight-of-evidence formula**.

3. The island problem

The simplest application of the previous part is the "island problem". This is a model where a crime is committed on an inaccessible island which contains N people who are unrelated to each other. At the beginning,

there is no information about the offender, so we assign to each of the islanders the same (prior) probability of committing a crime. Then the offender is found to possess a certain characteristic Υ and the suspect is also found to have that characteristic, Υ . The question becomes, to what extent can we be sure that we have found the suspect who is truly the culprit?

Using the formula (3) we get

$$P(G|E) = \frac{1}{1 + N \cdot p}, \quad (4)$$

where p is the probability of the Υ . For example if $p = 0.01$ and $N = 100$ then $P(G|E) = 1/2$.

The previous result can be modified for more complex (and realistic) situations. Let's see where our simple model can fail:

- *Typing and handling errors*
As the test may give erroneous results in a small percentage of cases, errors caused by human factor must also be considered: contamination or replacement of a sample from which the Υ -status is investigated; incorrect evaluation of the results, or even intentional misrepresentation.
- *The population size*
Often the population size N is only estimated and furthermore, if there is migration in the population, then it is necessary to account for greater uncertainty within the population size.
- *The probability of occurrence Υ in the population*
The value of p is usually unknown and is therefore estimated on the basis of relative frequency of the Υ in a smaller sample or in a similar population, about which we have more information. However, these auxiliary data may be outdated or may only partially describe the investigated population.
- *Suspect searching*
The suspect is not usually chosen randomly from the population but on the basis of other circumstantial evidence which increase the probability of guilt. Another possibility is choose the suspect by testing persons from the population for the presence of Υ . In this way, people who are not Υ -bearers can be excluded and thus the population size of alternative suspects is reduced.
- *Relatives and population subdivision*
If the suspect (or other person being tested) is a Υ -bearer and some of his relatives are included in the population too, then in the case of DNA profile

increases the probability of other persons having Υ due to inheritance. Similarly, unusually high relative frequency of a rare character usually occurs within the same subpopulation due to its shared evolution history.

- *The same prior probability of committing a crime*
Although this requirement intuitively corresponds with the general presumption of innocence, we can assess varying prior probability (i.e. based on the distance from the scene, time availability, or a possible alibi).

We will analyze some of these cases in detail in the following sections.

4. Uncertainty about population size

The uncertainty in population size of possible alternative suspects affects the prior probability, $P(G)$. Consider the population size \tilde{N} as a random variable with mean N . Prior probability of guilt, conditional on value \tilde{N} , is

$$P(G|\tilde{N}) = 1/(\tilde{N} + 1).$$

However, since \tilde{N} is not known, we use the expectation:

$$P(G) = \mathbb{E} [G|\tilde{N}] = \mathbb{E} \left[\frac{1}{\tilde{N} + 1} \right].$$

The function $1/(\tilde{N} + 1)$ is not symmetric, but is convex on the interval $(0, \infty)$. Therefore Jensen's inequality for convex functions ($\mathbb{E}[f(x)] \geq f(\mathbb{E}[x])$) implies

$$P(G) = \mathbb{E} \left[\frac{1}{\tilde{N} + 1} \right] \geq \frac{1}{N + 1}$$

because $\mathbb{E}[\tilde{N}] = N$.

Thus the uncertainty of the value N tends to favor the defendant. This effect is usually very small. Let it be shown in a concrete example.

For $\varepsilon \in (0, 0.5)$ we put

$$\tilde{N} = \begin{cases} N - 1 & \text{with probability } \varepsilon \\ N & \text{with probability } 1 - 2\varepsilon \\ N + 1 & \text{with probability } \varepsilon. \end{cases}$$

Then

$$\begin{aligned} P(G) &= \mathbb{E} \left[\frac{1}{\tilde{N} + 1} \right] = \frac{\varepsilon}{N} + \frac{1 - 2\varepsilon}{N + 1} + \frac{\varepsilon}{N + 2} = \\ &= \frac{1}{N + 1} + \frac{2\varepsilon}{N(N + 1)(N + 2)} \geq \frac{1}{N + 1} \end{aligned}$$

and if we put $\varepsilon = 0.25$ with $N = 100$ then $P(G)$ is greater than $1/(N + 1)$ by only 0.000000485.

Let's see what uncertainty in population size causes by using formula (4):

$$\begin{aligned} P(G|E) &= \frac{1}{1 + \sum_i R_i \frac{P(C_i)}{P(G)}} = \\ &= \frac{1}{1 + p \frac{1}{P(G)} \underbrace{\sum_i P(C_i)}_{=1-P(G)}} = \\ &= \frac{1}{1 + p \frac{N(N+1)(N+2)}{N^2+2N+2\varepsilon} \left(1 - \frac{N^2+2N+2\varepsilon}{N(N+1)(N+2)}\right)} = \\ &= \frac{1}{1 + Np \frac{N^3+2N^2-2\varepsilon}{N^3+2N^2+2N\varepsilon}} = \\ &= \frac{1}{1 + Np \left(1 - 2\varepsilon \frac{N+1}{N^3+2N^2+2N\varepsilon}\right)}. \end{aligned}$$

Again substituting $\varepsilon = 0.25$ and $N = 100$ we conclude that $P(G|E) = 0.5000124$ which, despite the high value of ε , differs from the original result of 50 %, which was calculated with a fixed N , by just one thousandth of a percent. Therefore, continuing with uncertainty about N ,

$$P(G|E) \approx \frac{1}{1 + Np(1 - 2\varepsilon/N^2)}$$

is very good approximation to take. In this example the approximation gives $P(G|E) = 0.5000125$, which is 50.00125 %.

Balding [1] uses an approximation order of worse magnitude

$$P(G|E) \approx \frac{1}{1 + Np(1 - 4\varepsilon/N^3)}$$

which gives our example the value $P(G|E) = 0.5000003$, or 50.00003 %.

5. Relatives and population structure

Alleles, which are identical and come from a common ancestor, are called identical by descent (*ibd*). The commonality of recent evolution history between two persons, whether relatives or members of the same subpopulation, increases the probability of *ibd* alleles occurrence. Therefore, the coancestry coefficient θ , indicating the probability that two randomly selected alleles

on fixed locus are ibd, is used as the measure of relatedness within subpopulations. Neglecting the influence of kinship and population structure leads to an overestimation of posterior probability of the suspect's guilt, and therefore ignoring this influence tends to cause disfavor for defendant. Thus, this topic is given considerable attention.

Consider a given locus with J alleles A_1, \dots, A_J whose probability of occurrence in the population is p_1, \dots, p_J , $\sum_{i=1}^J p_i = 1$. Allele proportions in the subpopulation can be modeled by the Dirichlet distribution ([5]) with parameters λp_i , $\lambda = \frac{1-\theta}{\theta(1-k)}$ where θ is the coancestry coefficient characterizing the subpopulation and k is the proportion of the subpopulation within the general population. Thus the probability of drawing m_i alleles A_i ($\sum_i m_i = n$) is given by

$$P(m_1, \dots, m_J) = \frac{\Gamma(\lambda)}{\Gamma(\lambda + n)} \prod_{i=1}^J \frac{\Gamma(\lambda p_i + m_i)}{\Gamma(\lambda p_i)}. \quad (5)$$

Putting $m = (m_1, \dots, m_J)$ we can adjust formula (5) to

$$P(m) = \frac{\prod_{j=1}^J \prod_{i=0}^{m_j-1} [(1-\theta)p_j + \theta i(1-k)]}{\prod_{i=0}^{n-1} [1-\theta + \theta i(1-k)]}. \quad (6)$$

The formula (6) is usually called **the beta-binomial sampling formula** and applies to ordered samples. If we want to use unordered samples, it is necessary to multiply the result by $\frac{n!}{m_1! \dots m_J!}$.

From the formula (6) we can also deduce the probability of certain allele withdrawal by using our knowledge of previous allele's withdrawal:

$$\begin{aligned} P(m_j + 1 | m_1, \dots, m_j, \dots, m_J) &= \\ &= \frac{(1-\theta)p_j + m_j\theta(1-k)}{1-\theta + n\theta(1-k)}. \end{aligned} \quad (7)$$

5.1. Application of beta-binomial formula

Denote G_C and G_S as culprit and suspect genotypes, respectively, and denote G_i as the genotype of a general person i . Then the likelihood ratio (2) can be rewritten as

$$\begin{aligned} R_i &= \frac{P(G_C = G_S = D | C_i)}{P(G_C = G_S = D | G)} = \\ &= \frac{P(G_i = G_S = D)}{P(G_S = D)} = P(G_i = D | G_S = D). \end{aligned}$$

Suppose first that the culprit has a homozygous profile $A_j A_j$. Then calculate the probability that the suspect has the same homozygous profile:

$$\begin{aligned} R_i &= P(G_i = A_j A_j | G_S = A_j A_j) \equiv P(A_j^2 | A_j^2) = \\ &= P(A_j | A_j^3) \cdot P(A_j | A_j^2) \end{aligned}$$

We know to calculate these conditional probabilities using (7). First we put $m_j = n = 2$ and then $m_j = n = 3$. Therefore

$$\begin{aligned} R_i &= \frac{[(1-\theta)p_j + 2\theta(1-k)]}{[1-\theta + 2\theta(1-k)]} \times \\ &\times \frac{[(1-\theta)p_j + 3\theta(1-k)]}{[1-\theta + 3\theta(1-k)]}. \end{aligned} \quad (8)$$

Similarly, we proceed for culprit with a heterozygous profile $A_j A_k$:

$$\begin{aligned} R_i &= P(G_i = A_j A_k | G_S = A_j A_k) \equiv \\ &\equiv P(A_j A_k | A_j A_k) = \\ &= P(A_k | A_j^2 A_k^1) P(A_j | A_j^1 A_k^1) + \\ &+ P(A_j | A_j^1 A_k^2) P(A_k | A_k^1 A_k^1). \end{aligned} \quad (9)$$

To quantify both expressions on the bottom line we put $m_j = 1, n = 2$ and $m_k = 1, n = 3$; $m_k = 1, n = 2$ and $m_j = 1, n = 3$ respectively. In total

$$\begin{aligned} R_i &= 2 \frac{[(1-\theta)p_j + \theta(1-k)]}{[1-\theta + 2\theta(1-k)]} \times \\ &\times \frac{[(1-\theta)p_k + \theta(1-k)]}{[1-\theta + 3\theta(1-k)]}. \end{aligned} \quad (10)$$

6. DNA mixtures

If the DNA sample is found to have more than two alleles at one locus, then it is defined as a mixture. The number of contributors to the mixture can be known or estimated, usually as $\lceil \frac{n}{2} \rceil$ where n is the maximum number of alleles detected. Due to the large number of situations which may arise we show for illustration only the case in which the victim (V) and one other person contribute to the mixture.

Thus the likelihood ratio R_i , defined by formula (2), can be rewritten as

$$\begin{aligned} R_i &= \frac{P(E_C, G_S, G_V | C_i)}{P(E_C, G_S, G_V | G)} = \\ &= \frac{P(E_C | G_S, G_V, C_i)}{P(E_C | G_S, G_V, G)} \cdot \frac{P(G_S, G_V | C_i)}{P(G_S, G_V | G)} = \\ &= \frac{P(E_C | G_S, G_V, C_i)}{P(E_C | G_S, G_V, G)} = \frac{P(E_C | G_V, C_i)}{P(E_C | G_S, G_V, G)}. \end{aligned} \quad (11)$$

6.1. Four alleles mixture

First we look at the case where the mixture consists of four alleles.

Suppose the following conditions apply:

1. None of the persons are considered relatives to each other.
2. The population is homogeneous (i.e. $\theta = 0$).
3. The population follows Hardy-Weinberg equilibrium.

Let the mixture be made up of alleles A, B, C , and D , with known probabilities of occurrence in the total population p_A, p_B, p_C , and p_D . Also let the suspect have alleles A and B and let the victim have alleles C and D . Then the denominator in the formula (11) is equal to one, the numerator is equal to the probability of observing the person with alleles A and B (which using the information above assumes the probability of occurrence $2p_A p_B$), and therefore, the likelihood ratio is

$$R_i = 2p_A p_B.$$

Suppose now that all considered persons have the same degree of relatedness to each other as expressed by the coancestry coefficient θ . Then according to (7)

$$\begin{aligned} R_i &= P(AB|ABCD) = \\ &= \frac{2[(1-\theta)p_A + \theta(1-k)][(1-\theta)p_B + \theta(1-k)]}{[1-\theta + 4\theta(1-k)][1-\theta + 5\theta(1-k)]}. \end{aligned}$$

6.2. Three alleles mixture

In the case of three alleles in the sample it is necessary to assume at least two contributors to the mixture. Consider alleles A, B , and C with probabilities p_A, p_B , and p_C . If the victim is homozygous for allele C , we get the same results as in the four allele's mixture.

Assume that the victim is heterozygous with alleles A and B and that the suspect is homozygous for allele C . Furthermore, assume that conditions 1 to 3 are fulfilled. Then the denominator of the formula (11) is again equal to one, the numerator is equal to the probability of observing a person who has the allele C and does not have a different allele other than A, B , or C , and

$$\begin{aligned} R_i &= P(AC) + P(BC) + P(CC) = \\ &= 2p_A p_C + 2p_B p_C + p_C^2. \end{aligned} \quad (12)$$

To include the population structure we use the formula (7) again:

$$\begin{aligned} R_i &= P(AC|ABCC) + P(BC|ABCC) + \\ &\quad + P(CC|ABCC) = \\ &= \frac{2[(1-\theta)p_A + \theta(1-k)][(1-\theta)p_C + 2\theta(1-k)]}{[1-\theta + 4\theta(1-k)][1-\theta + 5\theta(1-k)]} \\ &\quad + \frac{2[(1-\theta)p_B + \theta(1-k)][(1-\theta)p_C + 2\theta(1-k)]}{[1-\theta + 4\theta(1-k)][1-\theta + 5\theta(1-k)]} \\ &\quad + \frac{[(1-\theta)p_C + 3\theta(1-k)][(1-\theta)p_C + 2\theta(1-k)]}{[1-\theta + 4\theta(1-k)][1-\theta + 5\theta(1-k)]} \\ &= \frac{[(1-\theta)p_C + 2\theta(1-k)]}{[1-\theta + 4\theta(1-k)]} \times \\ &\quad \times \frac{[(1-\theta)(2p_A + 2p_B + p_C) + 7\theta(1-k)]}{[1-\theta + 5\theta(1-k)]}. \end{aligned}$$

We assumed in the previous calculation that the suspect is homozygous with alleles C . If he is heterozygote with alleles A and C , or B and C respectively, formula (12) remains unchanged under conditions 1 to 3. If population structure is included the likelihood ratio is

$$\begin{aligned} R_i &= \frac{[(1-\theta)p_C + \theta(1-k)]}{[1-\theta + 4\theta(1-k)]} \times \\ &\quad \times \frac{[(1-\theta)(2p_A + 2p_B + p_C) + 8\theta(1-k)]}{[1-\theta + 5\theta(1-k)]}. \end{aligned}$$

7. DNA database

DNA profiles, as sequences of alphanumeric data, allows relatively easy storage in the database. Therefore national databases began being created in the late 1990's and have continued to function since then. Currently there are three major forensic DNA databases: the Combined DNA Indexing System (CODIS), which is maintained by the United States FBI; the European Network of Forensic Science Institutes (ENFSI) DNA database; and the Interpol Standard Set of Loci (ISSOL) database maintained by Interpol.

All of these systems divide DNA database into two sub-databases. In *the crime scene database* the biological samples which are collected at the scene are stored and in *the convicted offender database* genetic profiles of persons convicted in the past are stored. These two databases are compared with one another and eventual agreement of profiles is examined by qualified professionals.

The type of offenses for which DNA is stored differs among countries and states. Initially, these databases contained only samples from violent offenders, such as those convicted of aggravated assault, rape, or murder.

However, the value of obtaining DNA from offenders of less severe crimes has been recognized more in recent times, as it has been discovered that many small time criminals often become repeat offenders, and in some cases more violent future offenders. However, the power of a large bank of DNA samples can sometimes serve as a deterrent. A match of DNA evidence from a crime scene (which would then be logged in the crime scene database) to one in the convicted offender database rapidly solves the crime rapidly and efficiently, saving time, effort, and money. Conversely, the use of DNA evidence can also immediately prove a suspect's innocence ([6]).

According to data from the United States in August of 2006, the crime scene database included approximately 150 000 profiles and the convicted offender database more than 3 500 000 profiles ([2]). The national database of United Kingdom currently consists of over four million profiles, and increases monthly by forty to fifty thousand. The success of this approach has been confirmed by the increase in the number of solved crimes from twenty-four to forty-three percent within the United Kingdom, since the creation of the DNA databases.

Therefore, the database system has the support of public. From a negative standpoint, the DNA often reveals

very sensitive, personal information and therefore it is necessary that databases are kept confidential and are thoroughly protected from abuse.

The Czech national database was created in 2002. After rapid development, the database now contains approximately ninety thousand genetic profiles.

References

- [1] D.J. Balding, *Weight-of-evidence for forensic DNA profiles*, John Wiley & Sons, Ltd, pp.15-63, 2005.
- [2] www.uoou.cz/uoou.aspx?menu=287&submenu=288, (available August 25, 2011).
- [3] H. Kubátová and J. Zvárová (supervisor), *Statistical methods for interpreting forensic DNA mixtures*, MFF UK, Praha, p. 20, 2010.
- [4] D. Slovák and J. Zvárová (supervisor), *Statistické metody stanovení váhy evidence v procesu identifikace jedince*, MFF UK, Praha, 2009.
- [5] S. Wright, *The genetical structure of populations*, Ann. Eugen. 15, pp. 323-354, 1951.
- [6] www.enotes.com/forensic-science/dna-evidence-social-issues, (available August 25, 2011).

Covariance Matrix Adaptation in Evolution Strategies

Post-Graduate Student:

ING. JAROSLAV ŠTASTNÝ

Department of Cybernetics, Faculty of Electrical Engineering,
Czech Technical University in Prague,
Technická 2,
160 00 Prague 6, CZ

jaroslav.stastny@gmail.com

Supervisor:

DOC. ING. RNDR. MARTIN HOLEŇA,
CSC.

Institute of Computer Science of the ASCR, v. v. i.
Pod Vodárenskou věží 2
182 07 Prague 8, CZ

martin@cs.cas.cz

Field of Study:

Artificial Intelligence and Biocybernetics

Abstract

Covariance Matrix Adaptation (CMA) is a stochastic optimization algorithm working in generations with populations of solutions. It has become the state-of-the-art in Evolution Strategies (ES) in solving multidimensional, multimodal and noisy optimization problems. The paper introduces the subject of ES, details the original version of CMA-ES. Its convenient advantages are summarized, consisting mainly in the invariance properties, as well as disadvantages, composed of tuning five parameters and no time improvement in working with larger populations. We give a survey of recent methods that deal with the limitations. Also, we describe CMA-ES based algorithm for multi-objective optimization.

1. Introduction

Evolution Strategies (ES), a subfield of Evolutionary Algorithms (EA), are stochastic numerical optimization methods for solving optimization problems, i.e. finding global optimum of an objective function $f : R^n \rightarrow R$, this function is denoted fitness function in EA terms. ESs put few assumptions on the objective function in comparison to classical optimization techniques, e.g. the function needs not be smooth, nor it makes any assumption about the convexity and linearity of the function. The ES works iteratively, one iteration is called a generation. In one generation, a set (called population) of candidate solutions to the optimization problem exists.

The population of solutions is sorted according to their fitness values. ESs employ rank-based selection using several schemes [1]. A (λ, μ) scheme samples λ new individuals (offspring) in every generation from μ parents, μ best offspring are selected as parents for the next ge-

neration and no current parent are passed to the next generation. A $(\lambda + \mu)$ scheme also samples λ offspring and selects μ best individuals as parents, however, it selects them from the union of parents and offspring. If an individual can be put into new generation without being mutated, then the algorithm is called elitist, thus (λ, μ) scheme is not elitist in contrast to the $(\lambda + \mu)$ one.

Sampling of new individuals (offspring) is done by means of a mutation operator, that usually adds a Gaussian random noise to a parent candidate solution. Formally, given a random variable of candidate solution $X \in R^n$, a realization $\mathbf{x}^{(g)}$ in generation g and $\mathbf{m}^{(g)}$ is the current favourite solution, the following equations are equivalent

$$\mathbf{x}^{(g)} \sim \mathbf{m}^{(g)} + \sigma \mathcal{N}(\mathbf{0}, \mathbf{C}^{(g)}) \quad (1)$$

$$\sim \mathbf{m}^{(g)} + \mathcal{N}(\mathbf{0}, \sigma^2 \mathbf{C}^{(g)}) \quad (2)$$

$$\sim \mathbf{m}^{(g)} + \sigma \sqrt{\mathbf{C}^{(g)}} \mathcal{N}(\mathbf{0}, \mathbf{I}), \quad (3)$$

where $\mathcal{N}(\mathbf{0}, \mathbf{C})$ represents a realization of multivariate normal distribution with zero mean and symmetric positive definite covariance matrix \mathbf{C} , which describe pairwise dependencies between one dimensional variables of the search space. This distribution is called the search distribution. σ is a positive value called the step size. ESs differ in construction of $\mathbf{m}^{(g)}$. \mathbf{I} stands for identity matrix.

Adaptation of search parameters, \mathbf{C} and σ , to the optimization problem is the subject of ES algorithms described below. In this paper we give a description of a state-of-the-art ES algorithm, the Covariance Matrix Adaptation Evolution Strategy (CMA-ES), with its properties (Section 2). The subsequent sections deal with modifications that enhance the algorithm in a specific way. Section 3 summarizes methods that reduce the number of generations needed to reach the optimum. In Section 4 it is argued that the covariance matrix should

be proportional to the inverse of the Hessian matrix of the fitness function. Section 5 introduces a simplified CMA-ES algorithm that requires only two parameters to be tuned. Section 6 reviews CMA-ES algorithms for multi-objective optimization problems.

2. Original CMA-ES algorithm

CMA-ES employs two basic principles of the parameter adaptation of the search distribution. The first, referred to as *derandomization*, consist in deterministic increase of probability of successful, i.e. better than its parent, candidate solutions and search steps by maximum likelihood method, which is done by updating the mean of the distribution so that the likelihood of previously successful candidate solutions is maximized. Also the covariance matrix is updated at every generation so that the likelihood of previously taken steps is also maximized.

Second, two sequences of the successive steps are recorded, they are called evolution paths and are expressed as a sum of consecutive steps. This summation is referred to as *cumulation*. One path is concerned with covariance matrix adaptation and the other with global step size adaptation.

The (μ, λ) -CMA-ES [2] generates λ offspring by

$$\mathbf{x}_k^{(g+1)} = \langle \mathbf{x} \rangle_{\mu}^{(g)} + \sigma^{(g)} \mathbf{z}_k^{(g)}, k = 1, \dots, \lambda, \quad (4)$$

$\mathbf{z}_k^{(g)} \sim \mathcal{N}(0, \mathbf{C}^{(g)})$ and

$$\langle \mathbf{x} \rangle_{\mu}^{(g)} = \sum_{i \in I_{sel}^{(g)}} w_i \mathbf{x}_i^{(g)} \quad (5)$$

corresponds to $\mathbf{m}^{(g)}$ in (1), it is the weighted mean of the μ best individuals in generation g , $I_{sel}^{(g)}$ is the set of indices of selected individuals of generation g , with $|I_{sel}^{(g)}| = \mu$, w_i sums to one over the best μ individuals. A common selection is the ordinary mean $w_i = 1/\mu$.

The positive definite covariance matrix $\mathbf{C}^{(g)}$ can be decomposed $\mathbf{C}^{(g)} = \mathbf{B}^{(g)} \mathbf{D}^{(g)} (\mathbf{B}^{(g)} \mathbf{D}^{(g)})^T = \mathbf{B}^{(g)} (\mathbf{D}^{(g)})^2 (\mathbf{B}^{(g)})^T$, which is eigenvalue decomposition of $\mathbf{C}^{(g)}$, where $\mathbf{B}^{(g)}$ is an orthogonal matrix whose columns are normalized eigenvectors of $\mathbf{C}^{(g)}$ and $\mathbf{D}^{(g)}$ is the diagonal matrix of square roots of eigenvalues. Thus $\mathcal{N}(0, \mathbf{C}^{(g)}) = \mathbf{B}^{(g)} \mathbf{D}^{(g)} \mathcal{N}(0, \mathbf{I})$.

As already mentioned, $\mathbf{C}^{(g)}$ is adapted by means of evolution path

$$\mathbf{p}_c^{(g+1)} = (1 - c_c) \cdot \mathbf{p}_c^{(g)} + c_c^u \cdot c_w \mathbf{B}^{(g)} \mathbf{D}^{(g)} \langle \mathbf{z} \rangle_{\mu}^{(g+1)},$$

where

$$c_c^u = \sqrt{c_c(2 - c_c)}, c_w = \frac{\sum_{i=1}^{\mu} w_i}{\sqrt{\sum_{i=1}^{\mu} w_i^2}},$$

c_c determines the cumulation time for \mathbf{p}_c , which is roughly $1/c_c$, c_c^u normalizes the variance of \mathbf{p}_c , as $(1 - c_c)^2 + (c_c^u)^2 = 1$. c_w is chosen so that under random selection $c_w \langle \mathbf{z} \rangle_{\mu}^{(g+1)}$ and $\mathbf{z}_k^{(g+1)}$ have the same variance and are identically distributed. Details of derivation can be found in [2]. Finally, the covariance matrix is adapted with rank-one matrix $\mathbf{p}_c^{(g+1)} (\mathbf{p}_c^{(g+1)})^T$,

$$\mathbf{C}^{(g+1)} = (1 - c_{cov}) \cdot \mathbf{C}^{(g)} + c_{cov} \cdot \mathbf{p}_c^{(g+1)} (\mathbf{p}_c^{(g+1)})^T. \quad (6)$$

Note also, that $\mathbb{E} \left[\mathbf{p}_c^{(g+1)} (\mathbf{p}_c^{(g+1)})^T \right] = \mathbf{C}^{(g)}$ was shown in [3]. This explains the usage of $(1 - c_{cov})$ in conjunction with c_{cov} in (6).

The global step size $\sigma^{(g)}$ is adapted via another evolution path $\mathbf{p}_{\sigma}^{(g+1)}$ where scaling with $\mathbf{D}^{(g)}$ is omitted,

$$\mathbf{p}_{\sigma}^{(g+1)} = (1 - c_{\sigma}) \cdot \mathbf{p}_{\sigma}^{(g)} + c_{\sigma}^u \cdot c_w \mathbf{B}^{(g)} \langle \mathbf{z} \rangle_{\mu}^{(g+1)} \quad (7)$$

$$\sigma^{(g+1)} = \sigma^{(g)} \cdot \exp \left(\frac{1}{d_{\sigma}} \cdot \frac{\|\mathbf{p}_{\sigma}^{(g+1)} - \hat{\chi}_n\|}{\hat{\chi}_n} \right), \quad (8)$$

where $\hat{\chi}_n = \mathbb{E} [\|\mathcal{N}(0, \mathbf{I})\|] = \sqrt{2} \Gamma(\frac{n+1}{2}) / \Gamma(\frac{n}{2})$ is the expectation of length of a $\mathcal{N}(0, \mathbf{I})$ distributed random vector.

Altogether, the so called strategy parameters $c_c, c_{cov}, c_{\sigma}, d_{\sigma}$ need to be tuned, apart from the λ and μ .

Algorithm 1 (μ, λ) -CMA-ES

- 1: input $c_c, c_{cov}, c_{\sigma}, d_{\sigma}$
 - 2: initialize $\sigma = 1, \mathbf{p}_{\sigma} = \mathbf{p}_c = 0, \mathbf{C} = \mathbf{I}, \langle x \rangle_{\mu} \in \mathcal{N}(0, \mathbf{I})$
 - 3: **repeat**
 - 4: **for** $i = 1, \dots, \lambda$ **do**
 - 5: $x_i \leftarrow \langle x \rangle + \sigma^{(g)} \mathcal{N}(0, \mathbf{C}^{(g)})$
 - 6: $f_i = \text{fitness}(x_i)$
 - 7: **end for**
 - 8: sort $x_{1, \dots, \lambda}$ according to fitness
 - 9: update mean (5)
 - 10: update evolution paths (6) and (7)
 - 11: update covariance matrix (6)
 - 12: update σ (8)
 - 13: **until** termination criterion is met
-

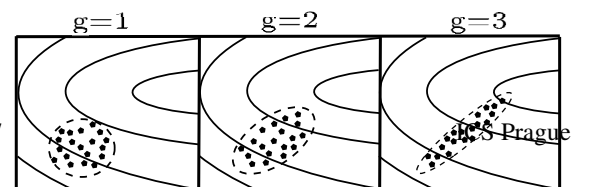

Figure 1: Illustration of CMA-ES work: Adaptation of covariance matrix (dashed ellipse) with sampled individuals across generations. The distribution shape can adapt to the landscape of the optimization problem.

Fig. 1 depicts possible time development of candidate solutions and the covariance matrix they were sampled with.

The properties of CMA-ES were concisely described in [4]. We will give a description of the majority of them.

Stationarity: The update equations satisfy unbiasedness of variations of the search and strategy parameters. Denote $\mathbf{m}^{(g)} = \langle \mathbf{x} \rangle_{\mu}^{(g)}$. Under neutral selection with $\mathbf{x}_i \sim \mathcal{N}(\mathbf{m}^{(g)}, (\sigma^{(g)})^2 \mathbf{C}^{(g)})$, we find that

$$\begin{aligned} \mathbb{E}[\mathbf{m}^{(g+1)} | \mathbf{m}^{(g)}] &= \mathbf{m}^{(g)}, \\ \mathbb{E}[\mathbf{C}^{(g+1)} | \mathbf{C}^{(g)}] &= \mathbf{C}^{(g)}, \\ \mathbb{E}[\ln \sigma^{(g)} | \sigma^{(g)}] &= \ln \sigma^{(g)}. \end{aligned}$$

Note, that the unbiasedness of $\ln \sigma$ does not imply unbiasedness for σ . Actually, $\mathbb{E}[\sigma^{(g+1)} | \sigma^{(g)}] > \sigma^{(g)}$. A bias toward increase or decrease can cause divergence or premature convergence, respectively, in cases when the selection pressure is low. However, for noisy data a controlled increase in the bias can be advantageous.

Invariance: Invariance properties of an optimization algorithm imply uniform performance on a class of fitness functions, which allows to generalize and predict future performance of the algorithm on different sets of data. Generally, translation invariance is required in any mathematical optimization algorithm CMA-ES. CMA-ES further exhibits the invariance under the strictly monotonic transformations of the fitness values, the algorithm depends only on the sorted order of the fitness function values. Also, invariance under rotation and reflection of the search space is preserved.

In practice, the drawback is the tuning of four parameters, the selection of which was empirically studied in the original article resulting in ad-hoc rules, but no theoretical studies were conducted to support them. Another drawback of the approach is slow convergence and no time improvement for the case of larger populations. In the next sections, we describe algorithms that try to the drawbacks and a CMA-ES algorithm for multi-objective optimization is introduced.

3. Time complexity reduction of CMA-ES

3.1. Adding higher rank information

In CMA-ES, the covariance matrix is updated in every generation with the outer product of the evolution path \mathbf{p}_c , which is a symmetrical $n \times n$ matrix of rank one. Hansen et al. [5] argues that information contained in larger populations can be exploited by adding a higher rank information with term

$$\begin{aligned} \mathbf{Z}^{(g+1)} &= \frac{1}{\mu} \sum_{i \in I_{\text{sel}}^{(g+1)}} \mathbf{K}^{(g)} \mathbf{z}_i^{(g+1)} \left(\mathbf{K}^{(g)} \mathbf{z}_i^{(g+1)} \right)^{\text{T}} \\ &= \mathbf{K}^{(g)} \left(\frac{1}{\mu} \sum_{i \in I_{\text{sel}}^{(g+1)}} \mathbf{z}_i^{(g+1)} \left(\mathbf{z}_i^{(g+1)} \right)^{\text{T}} \right) \left(\mathbf{K}^{(g)} \right)^{\text{T}}, \end{aligned} \quad (9)$$

where $\mathbf{K}^{(g)} = \mathbf{B}^{(g)} \mathbf{D}^{(g)}$. Equation (6) is modified to

$$\mathbf{C}^{(g+1)} = (1 - c_{\text{cov}}) \cdot \mathbf{C}^{(g)} + c_{\text{cov}} \cdot \mathbf{U}^{(g+1)}, \quad (10)$$

where

$$\mathbf{U}^{(g+1)} = \alpha_{\text{cov}} \cdot \mathbf{p}_c^{(g+1)} \left(\mathbf{p}_c^{(g+1)} \right)^{\text{T}} + (1 - \alpha_{\text{cov}}) \cdot \mathbf{Z}^{(g+1)}, \quad (11)$$

α_{cov} is the tuning parameter, $0 \leq \alpha_{\text{cov}} \leq 1$. Other equations remain unchanged. Decreasing α_{cov} results in greater weight on the new higher rank information and lower weight on the original rank one information, while increasing α_{cov} puts the weights vice-versa. It has been shown in [5] that $\mathbb{E}[\mathbf{Z}^{(g+1)}] = \mathbf{C}^{(g)}$, clearly $\mathbb{E}[\mathbf{C}^{(g+1)}] = \mathbf{C}^{(g)}$, therefore the coefficient $(1 - \alpha_{\text{cov}})$ is used in conjunction with α_{cov} in (10) and (11).

3.2. Efficient covariance matrix decomposition

Igel et al. [6] propose (1+1)-Cholesky-CMA-ES that replaces the computationally expensive eigenvalue decomposition of the covariance matrix with Cholesky decomposition running the rank-one update directly on the Cholesky factors. Given a symmetric positive definite matrix \mathbf{C} Cholesky decomposition puts

$$\mathbf{C} = \mathbf{A} \mathbf{A}^{\text{T}}, \quad (12)$$

with \mathbf{A} the lower triangular matrix with strictly positive diagonal entries. Assume $\mathbf{p}_c^{(g)} = \mathbf{A}^{(g)} \mathbf{z}^{(g)}$, $\mathbf{z}^{(g)} \sim \mathcal{N}(\mathbf{0}, \mathbf{I})$ in combination with (12) and (6), the Cholesky factor $\mathbf{A}^{(g)}$ can be shown to be equal to

$$\begin{aligned} \mathbf{A}^{(g+1)} &= c_a \mathbf{A}^{(g)} + \frac{c_a}{\|\mathbf{z}^{(g)}\|^2} \left(\sqrt{1 + \frac{(1 - c_a^2) \|\mathbf{z}^{(g)}\|^2}{c_a^2}} - 1 \right) \\ &\quad \times \mathbf{p}_c^{(g)} \mathbf{z}^{(g)\text{T}} \end{aligned} \quad (13)$$

with $c_a = \sqrt{1 - c_{\text{cov}}}$, for details of derivation and suggested parameter setting see [6].

The evolution path \mathbf{p}_c is not employed here, since its update would stall whenever the offspring is not successful, i.e. its fitness is worse than its parent. This would cause divergence of σ if the \mathbf{p}_c were long. Therefore, the cumulative step size adaptation is replaced by a success rule based step size control [7]. Consider $p_{\text{succ}} = \frac{\lambda_{\text{succ}}}{\lambda}$ denotes the success rate, which is the proportion of individuals λ_{succ} that have better fitness than its parent. Then, the so called average success rate \bar{p}_s smooths the step size σ of a general $(1 + \lambda)$ -CMA-ES by

$$\bar{p}_s^{(g+1)} = (1 - c_\sigma)\bar{p}_s^{(g)} + c_\sigma p_{\text{succ}} \quad (14)$$

$$\sigma^{(g+1)} = \sigma^{(g)} \exp\left(\frac{1}{d} \frac{\bar{p}_s^{(g+1)} - p_{\text{succ}}^{\text{target}}}{1 - p_{\text{succ}}^{\text{target}}}\right) \quad (15)$$

where $p_{\text{succ}}^{\text{target}}$, the target success probability, is a new strategy parameter. The update implements the heuristics that the step size should be increased if the success rate is high and decreased if the success rate is low. The rule is reflected in the (15), for $\bar{p}_s > p_{\text{succ}}^{\text{target}}$, the argument of the exponential is greater than zero resulting in increase of σ . For $\bar{p}_s = p_{\text{succ}}^{\text{target}}$, the argument is zero and no change in σ takes place. Finally, if $\bar{p}_s < p_{\text{succ}}^{\text{target}}$, the argument is lower than zero which results in a decrease of σ .

The (1+1)-Cholesky-CMA-ES inherits all invariance properties from the original version. It reads

Algorithm 2 (1+1)-Cholesky-CMA-ES

input: $p_{\text{succ}}^{\text{target}}, c_{\text{cov}}$
 initialize $\mathbf{x}_{\text{parent}}^{(g)} \sim \mathcal{N}(\mathbf{0}, \mathbf{I}), \sigma = 1, \mathbf{A} = \mathbf{I}$
repeat
 $\mathbf{x}_{\text{offspring}}^{(g)} = \mathbf{x}_{\text{parent}}^{(g)} + \sigma^{(g)} \mathbf{A}^{(g)} \mathcal{N}(\mathbf{0}, \mathbf{I})$
 update \bar{p}_s (14) and σ (15)
if $\text{fitness}(x_{\text{offspring}}) < \text{fitness}(x_{\text{parent}})$ **then**
 $x_{\text{parent}}^{(g+1)} = x_{\text{offspring}}^{(g)}$
 update $\mathbf{A}^{(g+1)}$ by (13)
end if
until termination criterion is met

The difference to (1+1)-CMA-ES, see e.g. [8], is the absent Cholesky factor and its respective updates, instead the update of C is employed. It introduces a new strategy parameter p_{tresh} . It uses the evolution path \mathbf{p}_c , it depends on averaged success rate \bar{p}_s . If $\bar{p}_s < p_{\text{tresh}}$, the update goes

$$\mathbf{p}_c^{(g+1)} = (1 - c_c)\mathbf{p}_c^{(g)} + \sqrt{c_c(2 - c_c)}\mathbf{x}_{\text{step}}, \quad (16)$$

$$\mathbf{C}^{(g+1)} = (1 - c_{\text{cov}})\mathbf{C}^{(g)} + c_{\text{cov}}\mathbf{p}_c^{(g+1)}\mathbf{p}_c^{(g+1)\text{T}}, \quad (17)$$

where

$$\mathbf{x}_{\text{step}} = \frac{\mathbf{x}_{\text{parent}}^{(g+1)} - \mathbf{x}_{\text{parent}}^{(g)}}{\sigma^{(g+1)}}$$

otherwise

$$\mathbf{p}_c^{(g+1)} = (1 - c_c)\mathbf{p}_c^{(g)} \quad (18)$$

$$\mathbf{C}^{(g+1)} = (1 - c_{\text{cov}})\mathbf{C}^{(g)} + c_{\text{cov}}\left(\mathbf{p}_c^{(g+1)}\mathbf{p}_c^{(g+1)\text{T}} + c_c(2 - c_c)\mathbf{C}^{(g)}\right) \quad (19)$$

Algorithm 3 (1+1)-CMA-ES

input: $p_{\text{succ}}^{\text{target}}, p_{\text{tresh}}, c_c, c_{\text{cov}}$
 initialize: $x_{\text{parent}}^{(g)}, \sigma = 1, \mathbf{p}_\sigma = \mathbf{p}_c = \mathbf{0}, \mathbf{C} = \mathbf{I}, \langle x \rangle_\mu \in \mathcal{N}(\mathbf{0}, \mathbf{I})$
repeat
 $x_{\text{offspring}}^{(g)} = x_{\text{parent}}^{(g)} + \sigma^{(g)}(g)\mathcal{N}(\mathbf{0}, \mathbf{C}^{(g)})$
 update evolution path p_σ (14) and σ (15)
if $\text{fitness}(x_{\text{offspring}}) < \text{fitness}(x_{\text{parent}})$ **then**
 $x_{\text{parent}} = x_{\text{offspring}}$
if $\bar{p}_{\text{succ}} < p_{\text{tresh}}$ **then**
 update $p_c^{(g+1)}, \mathbf{C}^{(g+1)}$ by (16), (17)
else
 update $p_c^{(g+1)}, \mathbf{C}^{(g+1)}$ by (18), (19)
end if
end if
until termination criterion not met

If \bar{p}_{succ} is high, above the threshold p_{tresh} , the update of the evolution path is p_c is stalled. This prevents excessively fast update of covariance matrix when the step size is small. If \bar{p}_{succ} is below the p_{tresh} , the p_c is updated only by exponential smoothing. In this case, the second summand in the update of p_c is missing (in comparison with the first case), which is compensated by the term $c_c(2 - c_c)$ in (19).

Suttorp et al. [9] extends the Cholesky-CMA-ES by introducing the inverse of $\mathbf{A}^{(g)}$, which allows the transformation $\mathbf{z}^{(g)} = \mathbf{A}^{(g)-1}\mathbf{p}_c^{(g)}$ for

$$\mathbf{A}^{(g+1)-1} = \frac{1}{c_a}\mathbf{A}^{(g)-1} - \frac{1}{c_a\|\mathbf{z}^{(g)}\|^2}f_c^{(g)}\mathbf{z}^{(g)}\mathbf{z}^{(g)\text{T}}\mathbf{A}^{(g)-1} \quad (20)$$

where

$$f_c^{(g)} = \left(1 - \frac{1}{\sqrt{1 + \frac{(1 - c_a^2)\|\mathbf{z}\|^2}{c_a^2}}}\right).$$

This improves the time complexity of one generation from $\mathcal{O}(n^3)$ to $\mathcal{O}(n^2)$.

4. Approximating the Hessian of fitness function

Auger [10] argues for the idea that the original CMA-ES does not make an optimal use of previously sampled points, when updating the covariance matrix. A better use of the points lies in learning the local curvature of the fitness function. The rationale behind this is shown on the optimization of sphere functions and then on elliptic functions.

Consider first the sphere functions, where the objective is to minimize the function $f_s(\mathbf{x}) = \mathbf{x}^T \mathbf{x}$. Numerical experiments [11] showed that in ES, the optimal covariance matrix is the identity matrix, which was supported by theoretical studies that put forward dynamical step size [12].

For elliptic functions, $f_e(\mathbf{x}) = \frac{1}{2} \mathbf{x}^T \mathbf{H} \mathbf{x}$, with positive definite symmetric matrix \mathbf{H} , the optimization problem is solved by variable change that will turn the problem into the sphere one. The matrix \mathbf{H} can be decomposed using eigenvalue decomposition $\mathbf{H} = \mathbf{P} \Delta^2 \mathbf{P}^T$ with orthonormal matrix \mathbf{P} with the eigenvectors of \mathbf{H} as columns and diagonal matrix Δ of square roots of eigenvalues of \mathbf{H} . If we let $\mathbf{W} = \Delta^{-1} \mathbf{P} \mathbf{X}$, then it is easy to see that $f_e(\mathbf{W}) = f_s(\mathbf{X})$ and that the mutation operator (1) with $\mathbf{C} = (\frac{1}{2} \mathbf{H})^{-1}$ transforms \mathbf{W}_0 into $\mathbf{W}_0 + \sigma \mathcal{N}(0, \mathbf{I})$. If we consider \mathbf{I} is the best choice for the covariance matrix for the sphere problem, then $(\frac{1}{2} \mathbf{H})^{-1}$ is the best choice for the covariance matrix for the elliptic problem.

Given that the gradient and the Hessian of the objective function exist, they can be locally approximated by Taylor series of second order resulting in elliptic equation. Suppose we want to approximate the Hessian matrix in point \mathbf{x}_0 , we have a set of N points $\mathbf{x}_j, j \dots, N$ in the vicinity of \mathbf{x}_0 their fitness values, the gradient ∇ and the Hessian matrix \mathbf{H} can be found by solving linear least squares problem

$$\min_{\nabla \in \mathbb{R}^d, \mathbf{H} \in \mathbb{R}^{d \times d}} \sum_{i=1}^N \left[f(\mathbf{x}_i) - f(\mathbf{x}_0) - (\mathbf{x}_i - \mathbf{x}_0)^T \nabla - \frac{1}{2} (\mathbf{x}_i - \mathbf{x}_0)^T \mathbf{H} (\mathbf{x}_i - \mathbf{x}_0) \right]^2 \quad (21)$$

The unknowns are ∇ (d elements) and \mathbf{H} ($d(d+1)/2$ elements). If we have more than $d(d+3)/2$ sample points, the overdetermined linear system of equations corresponding to (21) can be solved by means of pseudo-inversion with the cost of $\mathcal{O}(d^6)$. Note that for elliptic functions the least square value reaches 0, thus ∇ and \mathbf{H} can be determined exactly. For non-elliptic functions, the minimum is non-zero. Therefore, a metric

for determining the quality of approximation was developed in [10].

The proposed algorithm is $(1, \lambda)$ -LS-CMA-ES, σ is updated as in the original version. The Hessian matrix is calculated every n_{upd} iterations. If the approximation is sufficient, then the covariance matrix is updated by

$$\mathbf{C}^{(g+1)} = \left(\frac{1}{2} \mathbf{H}_f^{(g)} \right)^{-1}, \quad (22)$$

where $\mathbf{H}_f^{(g)}$ is the Hessian matrix in generation g . In the next n_{upd} generations, this matrix is used without updates and only the step size gets updated. If the approximation is poor, the update switches to the mode of standard CMA-ES for the next n_{upd} generations.

5. Simplified CMA-ES

The article [13] proposes a radical simplification of the covariance learning rule and the σ -self-adaptation approach. The new algorithm is called Covariance Matrix Simplified Adaptation Evolution Strategy (CMSA-ES). Both the evolution paths with exponential smoothing are not considered now. For each individual in the population, a mutation strength $\sigma_i^{(g)}$ is generated by logarithmic rule

$$\sigma_i^{(g+1)} = \bar{\sigma}^{(g)} \exp[\tau \mathcal{N}(0, 1)], i = 1, \dots, \lambda, \quad (23)$$

with $\bar{\sigma}^{(g)}$ the mean of $\sigma_i^{(g+1)}$ and a correlated random direction vector \mathbf{s}_i is generated

$$\mathbf{s}_i^{(g+1)} = \mathcal{N}(0, \mathbf{C}^{(g)}), \quad (24)$$

resulting in an offspring

$$\mathbf{x}_i^{(g+1)} = \langle \mathbf{x} \rangle_{\mu}^{(g)} + \sigma_i^{(g+1)} \mathbf{s}_i^{(g+1)} \quad (25)$$

The matrix $\mathbf{s}^{(g+1)}$ is formed from row vectors $\mathbf{s}_i^{(g+1)}$. The covariance matrix is updated by

$$\mathbf{C}^{(g+1)} = (1 - c_{\text{cov}}) \mathbf{C}^{(g)} + c_{\text{cov}} \mathbf{s}^{(g+1)} \left(\mathbf{s}^{(g+1)} \right)^T. \quad (26)$$

Here, only two parameters (c_{cov}, τ) needs to be tuned for which the authors provide hints. The empirical results showed that for large population sizes, original CMA-ES is outperformed by CMSA-ES in terms of number of generations needed to converge to (near) optimal solution.

6. CMA-ES for multi-objective optimization

Multi-objective optimization (MO) is concerned with optimizing several, often conflicting, criteria. The article [8] studies the usage of CMA-ES in MO preserving invariance properties of CMA-ES.

In MO, m fitness functions f_1, \dots, f_m , forming an objective vector $f(x) = (f_1(x), \dots, f_m(x))^T$, are minimized. Given solutions $\mathbf{x}, \mathbf{x}' \in R^n$ exist, we say \mathbf{x} dominates \mathbf{x}' , written as $\mathbf{x} \prec \mathbf{x}'$ iff $\forall i \in \{1, \dots, m\} : f_i(\mathbf{x}) \leq f_i(\mathbf{x}')$ and $\exists i \in \{1, \dots, m\} : f_i(\mathbf{x}) < f_i(\mathbf{x}')$. The elements of a (Pareto) set $Q_{\mathbf{x}} = \{\mathbf{x} | \mathbf{x} \in R^n \wedge \nexists \mathbf{x}' \in R^n : \mathbf{x}' \prec \mathbf{x}\}$ are not dominated by any element and are called Pareto-optimal. The Pareto set $Q_{\mathbf{x}}$ forms a Pareto front $f(\mathbf{x}), \mathbf{x} \in Q_{\mathbf{x}}$. Given no additional information, no Pareto-optimal solution can be said to be superior to any other. The goal of MO is to find a diversified Pareto set.

MO-CMA-ES ranks the individuals based on the level of non-dominance, which is inspired by the NSGA-II algorithm [14]. To rank individuals on the same level, two additional criteria were developed: the first is the crowding-distance, which provides an estimate of the density surrounding the non-dominated solution. It gives higher rank to individuals contributing more to the diversity of the objective vector. The second is the method of contributing hypervolume, which ranks best those individuals that contribute most to the hypervolume of the Pareto front. Both the secondary criteria cause that the resulting is not invariant to order-preserving transformation of fitness function.

The algorithm for multiobjective optimization is referred to as $\lambda_{MO} \times (1+1)$ -MO-CMA-ES. It contains a population of λ_{MO} elitist (1+1)-CMA-ES, described previously in Algorithm 3. In every generation, each individual $k, k = 1, \dots, \lambda_{MO}$ generates one offspring. The step size and covariance matrix of each offspring and its parent are updated according to the (1+1)-CMA-ES. All the parents and offspring are put in a set $R^{(g)}$, which ranks them and selects λ_{MO} individuals as parents for the next generation. Ranking, line 14 in the subsequence algorithm, is based on non-dominance in the first place, and crowding-distance or contributing hypervolume in the second place.

Algorithm 4 $\lambda_{MO} \times (1+1)$ -MO-CMA-ES

```

1: input:  $p_{\text{succ}}^{\text{target}}, p_{\text{tresh}}, c_{\text{cov}}, c_c$ ,
2: initialize:  $x_{\text{par},k} \sim \mathcal{N}(0, \mathbf{I}), \mathbf{C}_k = \mathbf{I}, \mathbf{p}_c = 0$ 
3: repeat
4:   for  $k = 1, \dots, \lambda_{MO}$  do
5:      $x_{\text{ind},k}^{(g)} \sim \mathcal{N}(x_{\text{par},k}^{(g)}, \mathbf{C}_k^{(g)})$ 
6:      $f_{\text{ind},k} = \text{fitness}(x_{\text{ind},k}^{(g)})$ 
7:      $f_{\text{par},k} = \text{fitness}(x_{\text{parent},k}^{(g)})$ 
8:   end for
9:    $R^{(g)} = \{f_{\text{ind},k}, f_{\text{par},k} | 1 \leq k \leq \lambda_{MO}\}$ 
10:  for  $k = 1, \dots, \lambda_{MO}$  do
11:    update  $\sigma$  of  $x_{\text{ind},k}^{(g)}$  using (14) and (15)
12:    update  $\sigma$  of  $x_{\text{par},k}^{(g)}$  using (14) and (15)
13:  end for
14:  if  $f_{\text{ind},k} < f_{\text{par},k}$  then
15:     $x_{\text{parent}} = x_{\text{offspring}}$ 
16:    if  $\bar{p}_{\text{succ}} < p_{\text{tresh}}$  then
17:      update  $\mathbf{C}_k^{(g+1)}$  by (16), (17)
18:    else
19:      update  $\mathbf{C}_k^{(g+1)}$  by (18), (19)
20:    end if
21:  end if
22:  select  $\lambda_{MO}$  individuals as parents for the next generation
23: until termination criterion not met

```

7. Summary

This work surveyed Covariance Matrix Adaptation, the state-of-the-art stochastic optimization method in Evolution Strategies. The algorithm was described with a discussion of its pros, above all the invariance properties, and cons, particularly a number of strategy parameters and almost no time improvement for large population. Several modifications were briefly described.

The CMSA-ES reduces the number of tuning parameters. Time complexity was reduced by modifications based on less time consuming decomposition of covariance matrix. LS-CMA-ES updates the covariance matrix by approximating the Hessian of the fitness function. Finally, a variant for multi-objective optimization was introduced.

The next work lies in a wider study of the CMA-ES based algorithms and enhancing the algorithm with new properties. Currently, we search to incorporate the copula approach [15]. Also we study the response surface methodology [16] to be applied in CMA-ES.

References

- [1] H. Beyer and H. Schwefel, "Evolution strategies—a comprehensive introduction," *Natural computing*, Vol. 1, No. 1, pp. 3-52, 2002.
- [2] N. Hansen and A. Ostermeier, "Completely derandomized self-adaptation in evolution strategies," *Evolutionary computation*, Vol. 9, No. 2, pp. 159-195, 2001.
- [3] N. Hansen, *Verallgemeinerte individuelle Schrittweitenregelung in der Evolutionsstrategie. Eine Untersuchung zur entstochastisierten, koordinatensystemunabhängigen Adaptation der Mutationsverteilung*. Phd thesis, D 83, Berlin, 1998. ISBN 3-933346-29-0.
- [4] N. Hansen, "The CMA evolution strategy: a comparing review," in *Towards a new evolutionary computation. Advances on estimation of distribution algorithms* (J. Lozano, P. Larranaga, I. Inza, and E. Bengoetxea, eds.), pp. 75-102, Springer, 2006.
- [5] N. Hansen, S. Muller, and P. Koumoutsakos, "Reducing the time complexity of the derandomized evolution strategy with covariance matrix adaptation (CMA-ES)," *Evolutionary Computation*, Vol. 11, No. 1, pp. 1-18, 2003.
- [6] C. Igel, T. Suttorp, and N. Hansen, "A computational efficient covariance matrix update and a (1+1)-CMA for evolution strategies," in *Proceedings of the 8th annual conference on Genetic and evolutionary computation*, pp. 453-460, ACM, 2006.
- [7] S. Kern, S. Müller, N. Hansen, D. Büche, J. Ocenasek, and P. Koumoutsakos, "Learning probability distributions in continuous evolutionary algorithms—a comparative review," *Natural Computing*, Vol. 3, No. 1, pp. 77-112, 2004.
- [8] C. Igel, N. Hansen, and S. Roth, "Covariance matrix adaptation for multi-objective optimization," *Evolutionary Computation*, Vol. 15, No. 1, pp. 1-28, 2007.
- [9] T. Suttorp, N. Hansen, and C. Igel, "Efficient covariance matrix update for variable metric evolution strategies," *Machine Learning*, Vol. 75, No. 2, pp. 167-197, 2009.
- [10] A. Auger, M. Schoenauer, and N. Vanhaecke, "LS-CMA-ES: A second-order algorithm for covariance matrix adaptation," in *Parallel Problem Solving from Nature-PPSN VIII*, pp. 182-191, Springer, 2004.
- [11] T. Bäck and H. Schwefel, "An overview of evolutionary algorithms for parameter optimization," *Evolutionary computation*, Vol. 1, No. 1, pp. 1-23, 1993.
- [12] A. Auger, C. Le Bris, and M. Schoenauer, "Dimension-independent convergence rate for non-isotropic $(1, \lambda)$ -ES," in *Genetic and Evolutionary Computation—GECCO 2003*, pp. 204-204, Springer, 2003.
- [13] H. Beyer and B. Sendhoff, "Covariance matrix adaptation revisited—the CMSA Evolution Strategy—," *Parallel Problem Solving from Nature-PPSN X*, pp. 123-132, 2008.
- [14] K. Deb, A. Pratap, S. Agarwal, and T. Meyarivan, "A fast and elitist multiobjective genetic algorithm: NSGA-II," *Evolutionary Computation, IEEE Transactions on*, Vol. 6, No. 2, pp. 182-197, 2002.
- [15] R. Nelsen, *An Introduction to Copulas*. Springer Verlag, 2006.
- [16] D. Jones, "A taxonomy of global optimization methods based on response surfaces," *Journal of Global Optimization*, Vol. 21, No. 4, pp. 345-383, 2001.

Interaction-Sensitive Fuzzy Measure in Dynamic Classifier Aggregation: an Experimental Comparison

Post-Graduate Student:

ING. DAVID ŠTEFKA

Department of Mathematics
Faculty of Nuclear Science and Physical Engineering
Czech Technical University
Trojanova 13
120 00 Prague 2, CZ

david.stefka@gmail.com

Supervisor:

ING. RNDR. MARTIN HOLEŇA, CSC.

Institute of Computer Science of the ASCR, v. v. i.
Pod Vodárenskou věží 2
182 07 Prague 8, CZ

martin@cs.cas.cz

Field of Study:
Mathematical Engineering

The research reported in this paper was partially supported by the grant ME949 of the Ministry of Education, Youth and Sports of the Czech Republic.

Abstract

In dynamic classifier aggregation, the fuzzy integral is used often as an aggregation operator. As the fuzzy measure of the integral, Sugeno λ -measure (which belongs to a more general class of \perp -decomposable fuzzy measures) is used most often. However, there is usually no explicit reason why this particular measure is used, and moreover, the measure cannot model the similarities of the individual classifiers in the team. In this paper, we show that \perp -decomposable measures are not appropriate for classifier combining, and we introduce the Interaction-Sensitive Fuzzy Measure (ISFM), designed specifically for classifier combining. The experiments with 3 different classifier systems on 26 benchmark datasets show that ISFM outperforms the Sugeno λ -measure in most cases.

1. Introduction

This paper is an extension of [1], in which we introduced the Interaction-Sensitive Fuzzy Measure. In this paper, we discuss the ISFM in more detail and perform more experiments.

Classifier combining methods are a popular tool for improving the quality of classification. Instead of using just one classifier, a team of classifiers is created, and the predictions of the team are combined into a single prediction [2–4]. There are two main approaches to classifier combining: *classifier selection* (where a single classifier from the team is selected for prediction according to some criterion) and *classifier aggregation* (where the outputs of the classifiers are aggregated into a single prediction). Classifier combination can be either *static*, i.e.,

the combining process is the same for all patterns, or *dynamic*, where the combination process is adapted to the currently classified pattern [5–9].

One of the popular aggregation operators is the *fuzzy integral* [2, 10–12]. The fuzzy integral aggregates the outputs of the individual classifiers in the team with respect to a fuzzy measure, representing the classification confidences. *Fuzzy measure* is a generalization of the additive probabilistic measure, where the additivity is replaced by a weaker condition, monotonicity – this gives us a tool which can model interactions between different elements of the fuzzy measure space. However, due to the lack of additivity, the fuzzy measure needs to be defined on all subsets of the fuzzy measure space, resulting in 2^r defining values for finite cases, where r is the size of the universe. There are several approaches to overcome this weakness: *symmetric fuzzy measures* [10], for which the value of the measure depends only on the number of elements in the argument, and *\perp -decomposable fuzzy measures*, including *Sugeno λ -measure* [10, 11], for which the fuzzy measure values are computed from the fuzzy measure values for the singletons (called *fuzzy densities*) using a fixed t-conorm \perp . However, since the value of a set of elements is computed only using the fuzzy densities of its elements and a fixed \perp , the similarity of the elements in the set is not taken into account, and the ability to model interactions between different elements of the fuzzy measure universe is limited.

In the literature of classifier aggregation, fuzzy integral is usually used with Sugeno λ -measure. There is usually no explicit reason for the choice of this measure other than its simplicity. Sugeno λ -measure is a special case of a \perp -decomposable fuzzy measure, and as such, it cannot

model similarities between the individual classifiers, and thus the contribution of using fuzzy integral is unclear.

In classifier aggregation, we usually try to create a team of classifiers that are not similar. This property is called *diversity* [13]. There are many methods for building a diverse team of classifiers [3, 14–16]; however, the team always contains classifiers that are similar. If we use the fuzzy integral with a symmetric or \perp -decomposable fuzzy measure, we are not able to incorporate the diversity into the measure (and thus to the aggregation process), because the fuzzy measure of a union of two sets is a function only of the fuzzy measures of the two sets, regardless of the similarity of the elements in the sets.

To overcome this weakness, we have introduced an *Interaction-Sensitive Fuzzy Measure* (ISFM) [1], which is defined using the fuzzy measure values for the singletons (fuzzy densities), and the similarities of the elements in the universe. If the fuzzy measure space corresponds to the team of classifiers, the fuzzy measure incorporates both the classification confidence (fuzzy densities), and the diversity of the team of classifiers (mutual similarities of the classifiers). Using ISFM in fuzzy integral as an aggregation operator in classifier aggregation, the aggregation process involves all the important properties: the predictions of the classifiers, the classification confidences, and the diversity of the team.

Our preliminary experiments with ISFM used with the Choquet integral in Random Forest ensembles have shown that ISFM outperforms Sugeno λ -measure [1]. In this paper, the results of a more profound investigation are reported, and the experiments have been extended to cover the Sugeno integral and also other classification models, namely ensembles of k-Nearest Neighbor classifiers [17] created by bagging [14] and ensembles of Quadratic Discriminant Classifiers [17] created by the Multiple feature subset method [18].

The paper is structured as follows. In Section 2, we briefly summarize the formalism of classification, classification confidence, and classifier combining. Section 3 describes fuzzy measures, fuzzy integrals, and their use in classifier aggregation. In Section 4, we introduce the ISFM, and in Section 5, we experimentally compare the performance of the ISFM to the performance of the Sugeno λ -measure. Section 6 then summarizes the paper.

2. Classifier Combining

In this section, we recall the formalism of dynamic classifier combining, proposed in [5]. Throughout the rest of the paper, we use the following notation. Let $\mathcal{X} \subseteq \mathbf{R}^n$

be a n -dimensional *feature space*, let $C_1, \dots, C_N \subseteq \mathcal{X}$, $N \geq 2$ be disjoint sets called *classes*. A *pattern* is a tuple $(\vec{x}, c_{\vec{x}})$, where $\vec{x} \in \mathcal{X}$ are *features* of the pattern, and $c_{\vec{x}} \in \{1, \dots, N\}$ is the index of the class the pattern belongs to. The goal of classification is to determine the class a given pattern belongs to, i.e., to predict $c_{\vec{x}}$ for unclassified patterns. We assume that for

every $\vec{x} \in \mathcal{X}$, there is a unique classification $c_{\vec{x}}$, but since it is usually not known, we will sometimes refer to a pattern only as $\vec{x} \in \mathcal{X}$.

Definition 1 *The term classifier denotes a mapping $\phi : \mathcal{X} \rightarrow [0, 1]^N$, i.e., for $\vec{x} \in \mathcal{X}$, $\phi(\vec{x}) = (\gamma_1(\vec{x}), \dots, \gamma_N(\vec{x}))$. The components $(\gamma_1(\vec{x}), \dots, \gamma_N(\vec{x}))$ are called degrees of classification (d.o.c.) to each class.*

The d.o.c. to class C_j expresses the predicted extent to which the pattern belongs to class C_j . The prediction of $c_{\vec{x}}$ for an unknown pattern \vec{x} is done by converting the continuous d.o.c. of the classifier into a *crisp output* $\phi^{(cr)}(\vec{x}) = \arg \max_{i=1, \dots, N} \gamma_i(\vec{x})$ if there are no ties, or arbitrarily as $\phi^{(cr)}(\vec{x}) \in \arg \max_{i=1, \dots, N} \gamma_i(\vec{x})$ in the case of ties.

2.1. Classification Confidence

In addition to the classifier output (the d.o.c.), which predicts to which class a pattern belongs, we will work with the *confidence* of the prediction, i.e., the extent to which we can “trust” the output of the classifier.

Definition 2 *Let ϕ be a classifier and $\kappa_{\phi} : \mathcal{X} \rightarrow [0, 1]$. Then κ_{ϕ} is called a confidence measure and for $\vec{x} \in \mathcal{X}$, $\kappa_{\phi}(\vec{x})$ is called classification confidence of ϕ on \vec{x} . A confidence measure is called static if it is a constant of the classifier, and dynamic otherwise.*

The higher the trust in the classification, the closer $\kappa_{\phi}(\vec{x})$ is to 1. Static confidence measures evaluate the classifier as a whole and they are usually computed on a validation set after the classifier is trained. The methods include accuracy, precision, sensitivity, resemblance, etc. [17, 19]. For example, the Global Accuracy confidence measure is defined as:

$$\kappa_{\phi}^{(GA)} = \frac{\sum_{(\vec{y}, c_{\vec{y}}) \in \mathcal{V}} I(\phi^{(cr)}(\vec{y}) = c_{\vec{y}})}{|\mathcal{V}|}, \quad (1)$$

where $\mathcal{V} \subseteq \mathcal{X} \times \{1, \dots, N\}$ is the validation set and I denotes the indicator operator, defined as $I(\text{true}) = 1$, $I(\text{false}) = 0$ (we will use the notation in the rest of the paper).

Dynamic confidence measures [5–9, 20] adapt to the currently classified pattern and predict the local quality of the classification for the particular pattern $(\vec{x}, c_{\vec{x}})$. An example of a dynamic confidence measure is the Euclidean Local Accuracy (ELA):

$$\kappa_{\phi}^{(ELA)}(\vec{x}) = \frac{\sum_{(\vec{y}, c_{\vec{y}}) \in \mathcal{V}(\vec{x})} I(\phi^{(cr)}(\vec{y}) = c_{\vec{y}})}{|\mathcal{V}(\vec{x})|}, \quad (2)$$

where $\mathcal{V}(\vec{x}) \subseteq \mathcal{V}$ is the set of validation patterns belonging to some kind of neighborhood of \vec{x} (for example k nearest neighbors under Euclidean metric).

2.2. Classifier Systems

In classifier combining, instead of using just one classifier, a team of classifiers is created (sometimes called an *ensemble of classifiers*), and the team is then aggregated into one final classifier. If we want to utilize classification confidence in the aggregation process, each classifier must have its own confidence measure defined.

Definition 3 Let $r \in \mathbb{N}$, $r \geq 2$. Classifier team is a tuple (Γ, \mathcal{K}) , where $\Gamma = \{\phi_1, \dots, \phi_r\}$ is a set of classifiers, and $\mathcal{K} = \{\kappa_{\phi_1}, \dots, \kappa_{\phi_r}\}$ is a set of corresponding confidence measures.

If a pattern \vec{x} is submitted for classification, the team of classifiers returns information of two kinds – outputs of the individual classifiers (a *decision profile* [21]), and classification confidences of the classifiers on \vec{x} (a *confidence vector*).

Definition 4 Let (Γ, \mathcal{K}) be a classifier team and let $\vec{x} \in \mathcal{X}$. Then the decision profile of (Γ, \mathcal{K}) on \vec{x} is a matrix $\Gamma(\vec{x}) \in [0, 1]^{r \times N}$,

$$\Gamma(\vec{x}) = \begin{pmatrix} \phi_1(\vec{x}) \\ \phi_2(\vec{x}) \\ \vdots \\ \phi_r(\vec{x}) \end{pmatrix} = \begin{pmatrix} \gamma_{1,1}(\vec{x}) & \gamma_{1,2}(\vec{x}) & \dots & \gamma_{1,N}(\vec{x}) \\ \gamma_{2,1}(\vec{x}) & \gamma_{2,2}(\vec{x}) & \dots & \gamma_{2,N}(\vec{x}) \\ \vdots & \vdots & \ddots & \vdots \\ \gamma_{r,1}(\vec{x}) & \gamma_{r,2}(\vec{x}) & \dots & \gamma_{r,N}(\vec{x}) \end{pmatrix}, \quad (3)$$

and the confidence vector of (Γ, \mathcal{K}) on \vec{x} is a vector $\mathcal{K}(\vec{x}) \in [0, 1]^r$,

$$\mathcal{K}(\vec{x}) = \begin{pmatrix} \kappa_{\phi_1}(\vec{x}) \\ \kappa_{\phi_2}(\vec{x}) \\ \vdots \\ \kappa_{\phi_r}(\vec{x}) \end{pmatrix} \quad (4)$$

After the pattern \vec{x} has been classified by all the classifiers in the team, and the confidences have been computed, these outputs have to be aggregated using a *team*

aggregator. A classifier team with an aggregator will be called a *classifier system*, which can be also viewed as a single classifier.

Definition 5 Let (Γ, \mathcal{K}) be a classifier team, and let $\mathcal{A} : [0, 1]^{r \times N} \times [0, 1]^r \rightarrow [0, 1]^N$. The triple $\mathcal{S} = (\Gamma, \mathcal{K}, \mathcal{A})$ is called a classifier system and \mathcal{A} is called a team aggregator. We define an induced classifier of \mathcal{S} as a classifier Φ :

$$\Phi(\vec{x}) = \mathcal{A}(\Gamma(\vec{x}), \mathcal{K}(\vec{x})) = (\gamma_1(\vec{x}), \dots, \gamma_N(\vec{x})).$$

An example of an aggregation operator is the mean value, which defines the aggregated d.o.c. to class j as the arithmetic mean of the d.o.c. to class j given by the individual classifiers in the team:

$$\gamma_j(\vec{x}) = \frac{\sum_{i=1, \dots, r} \gamma_{i,j}(\vec{x})}{r}. \quad (5)$$

We can distinguish three types of classifier systems: *confidence-free* (which do not utilize the classification confidence at all), *static* (which use only static classification confidence), and *dynamic* (which use dynamic classification confidence, i.e., the aggregation is adapted to a particular pattern). In this paper, we are mainly interested in dynamic classifier systems.

Many aggregation operators have been studied in the literature: simple arithmetic operations (voting, sum, maximum, minimum, mean, weighted mean, weighted voting, product, etc., [21]), probability-based approaches (e.g., product rule [21], Dempster-Shafer fusion [21]), and fuzzy logic methods (fuzzy integral [12], decision templates [12, 21]). Our key interest in this paper lies in studying dynamic classifier aggregation using the fuzzy integral, which is described in the following section.

3. Fuzzy Integral, Measures and Similarity

Fuzzy integral [10, 11, 22] is an aggregation operator, based on a *fuzzy measure* (sometimes called *capacity*), which is a generalization of the additive measure, such that the additivity is replaced by a weaker condition – monotonicity. Several definitions of a fuzzy integral exists in the literature – among them, the Choquet integral and the Sugeno integral are used most often. In this section, we briefly summarize the basic definitions, and we show how the fuzzy integral can be used in classifier aggregation. For simplicity reasons, we restrict ourselves to the discrete case, and to functions in $[0, 1]$.

Definition 6 A fuzzy measure μ on a set $\mathcal{U} = \{u_1, \dots, u_r\}$ is a function on the power set of \mathcal{U} , $\mu : \mathcal{P}(\mathcal{U}) \rightarrow [0, 1]$, such that:

1. $\mu(\emptyset) = 0, \mu(\mathcal{U}) = 1$ (boundary conditions)
2. $A \subseteq B \Rightarrow \mu(A) \leq \mu(B)$ (monotonicity)

As the universe \mathcal{U} will correspond to the set of classifiers in the team, we use r to denote the universe size (cf. Sec. 3.1). We can now define the Choquet integral, which is a generalization of the classical probabilistic integral (for additive measures, it reduces to the Lebesgue integral, i.e., weighted mean in the discrete case), and the Sugeno integral. As there is no generally accepted definition of a fuzzy integral [10, 23], we restrict ourselves to the Choquet and Sugeno integrals in the rest of the paper.

We will use the following notation. Let $f : \mathcal{U} = \{u_1, \dots, u_r\} \rightarrow [0, 1]$, $f(u_i) = f_i$, $i = 1, \dots, r$. Then $\langle \cdot \rangle$ indicates that the indices have been permuted, such that $0 = f_{\langle 0 \rangle} \leq f_{\langle 1 \rangle} \leq \dots \leq f_{\langle r \rangle} \leq 1$. Moreover, $A_{\langle i \rangle} = \{u_{\langle i \rangle}, \dots, u_{\langle r \rangle}\}$ denotes the set of elements of \mathcal{U} corresponding to the $(r - i)$ highest values of f .

Definition 7 Let μ be a fuzzy measure on \mathcal{U} . Then the Choquet integral of a function $f : \mathcal{U} \rightarrow [0, 1]$, $f(u_i) = f_i$, $i = 1, \dots, r$, with respect to μ is defined as:

$$(C) \int f d\mu = \sum_{i=1}^r (f_{\langle i \rangle} - f_{\langle i-1 \rangle}) \mu(A_{\langle i \rangle}). \quad (6)$$

Definition 8 Let μ be a fuzzy measure on \mathcal{U} . Then the Sugeno integral of a function $f : \mathcal{U} \rightarrow [0, 1]$, $f(u_i) = f_i$, $i = 1, \dots, r$, with respect to μ is defined as:

$$(S) \int f d\mu = \max_{i=1}^r \min(f_{\langle i \rangle}, \mu(A_{\langle i \rangle})). \quad (7)$$

3.1. Fuzzy Integral in Classifier Aggregation

In classifier aggregation, the universe \mathcal{U} corresponds to the set of classifiers Γ in the team, i.e., $\mathcal{U} = \Gamma = \{\phi_1, \dots, \phi_r\}$. For $\vec{x} \in \mathcal{X}$, the individual columns of the decision profile $\Gamma(\vec{x})$ are integrated using the fuzzy integral, i.e., the aggregated d.o.c. to class j is defined as

$$\gamma_j(\vec{x}) = \int \Gamma_{*,j} d\mu, \quad (8)$$

where \int is a fuzzy integral, $\Gamma_{*,j}$ is the j -th column of Γ (d.o.c. to class C_j), and μ is a fuzzy measure on Γ . The

fuzzy measure μ represents the importance of a particular set of classifiers used in the integration ($\mu(A_{\langle i \rangle})$ represents the importance of the classifiers corresponding to the $(r - i)$ highest d.o.c.). Usually, μ somehow depends on the confidence vector $\mathcal{K}(\vec{x})$.

3.2. Important Types of Fuzzy Measures

The behavior of the fuzzy integral depends heavily on the considered fuzzy measure. As the definition of a fuzzy measure is very general, it gives us a lot of freedom when defining a fuzzy measure. However, to define a general fuzzy measure in the discrete case, we need to define all its 2^r values, which is usually very complicated. To overcome this weakness, approaches which do not need all the 2^r values have been developed [10, 11].

3.2.1 Additive Measures:

Definition 9 Fuzzy measure μ on \mathcal{U} is called additive, if $\mu(A \cup B) = \mu(A) + \mu(B)$ for disjoint $A, B \subseteq \mathcal{U}$.

Additive measures correspond to the classical probabilistic measures. The measure is defined only using the values for the singletons, $\mu(\{u_i\})$, $i = 1, \dots, r$ (called *fuzzy densities*), and all the remaining values are computed using the additivity condition. However, such measure cannot model interaction between the elements of the fuzzy measure space (which in particular implies that the diversity of the team of classifiers cannot be taken into account in the aggregation). Choquet integral with an additive measure reduces to the weighted mean.

3.2.2 Symmetric Measures:

Definition 10 Fuzzy measure μ on \mathcal{U} is called symmetric, if for $A, B \subseteq \mathcal{U}$, $|A| = |B| \Rightarrow \mu(A) = \mu(B)$, i.e., its value depends only on the cardinality of the argument, $\mu(A) = g(|A|)$.

We can choose any nondecreasing function g , such that $g(0) = 0$ and $g(r) = 1$ to model the importance of a set of r elements. If a symmetric measure is used in Choquet integral, the integral reduces to the Ordered Weighted Average operator [10]. However, symmetric measures assume that all the classifiers have the same importance, and thus not only symmetric fuzzy measures do not take similarities of the classifiers into account, but moreover, the resulting aggregation scheme is confidence-free, i.e., the classificoin confidence does not influence the aggregation. As we deal with dynamic classifier systems only, we do not take symmetric measures into account in the rest of the paper.

3.2.3 \perp -decomposable Measures:

Definition 11 Let μ be a fuzzy measure on \mathcal{U} and let \perp be a t -conorm. Then μ is called \perp -decomposable, if for disjoint $A, B \subseteq \mathcal{U}$,

$$\mu(A \cup B) = \mu(A) \perp \mu(B). \quad (9)$$

\perp -decomposable measures need only the r fuzzy densities and all the other values are computed using the formula (9). Particular cases of \perp -decomposable fuzzy measures are additive measures (\perp being the bounded sum), and the Sugeno λ -measure [10, 11], defined as

$$\mu(A \cup B) = \mu(A) + \mu(B) + \lambda\mu(A)\mu(B), \quad (10)$$

for disjoint $A, B \in \mathcal{U}$, and some fixed $\lambda > -1$. The value of λ is computed as the unique non-zero root greater than -1 of the equation

$$\lambda + 1 = \prod_{i=1, \dots, r} (1 + \lambda\mu(\{u_i\})), \quad (11)$$

if the densities do not sum to 1. If they do sum to 1, $\lambda = 0$ and the fuzzy measure is additive.

The Sugeno λ -measure is used most often in classifier aggregation using fuzzy integral (with the fuzzy densities corresponding to the classification confidences, $\mu(\{u_i\}) = \kappa_{\phi_i}(\vec{x})$). However, its use is usually not supported by any arguments and it is basically selected because of its simplicity.

A strong weakness of any \perp -decomposable measure (and Sugeno λ -measure in particular) is that it cannot model the interaction (similarities) between the classifiers, because the fuzzy measure value of a set of two (or more) classifiers is fully determined by the formula (9) with a fixed \perp . Therefore, the diversity of the team of classifiers cannot be taken into account in the aggregation (as in the case of additive measures).

To overcome the weaknesses of the methods presented above, we have defined an Interaction-Sensitive Fuzzy Measure (ISFM) [1], which is defined not only using the fuzzy densities, but also using mutual similarities of the classifiers in the team. The method is described in the following section, but prior to that, we formally define the concept of a similarity [24].

3.3. Similarity of Classifiers

Definition 12 Let \wedge be a t -norm and let $S : \mathcal{U} \times \mathcal{U} \rightarrow [0, 1]$ be a fuzzy relation. S is called a similarity with respect to \wedge if the following holds $\forall a, b, c \in \mathcal{U}$:

- $S(a, a) = 1$ (reflexivity)
- $S(a, b) = S(b, a)$ (symmetry)
- $S(a, b) \wedge S(b, c) \leq S(a, c)$ (transitivity w.r.t. \wedge)

In the context of classifier combining, we will work with similarity of classifiers in particular, which, for classifiers ϕ_k, ϕ_l , will be measured empirically as the proportion of equal crisp predictions on the validation set \mathcal{V} ,

$$S(\phi_k, \phi_l) = \frac{\sum_{(\vec{y}, c_{\vec{y}}) \in \mathcal{V}} I(\phi_k^{(cr)}(\vec{y}) = \phi_l^{(cr)}(\vec{y}))}{|\mathcal{V}|}. \quad (12)$$

The relation (12) is a similarity with respect to Łukasiewicz t -norm \wedge_L , but it is not a similarity with respect to standard or product t -norms \wedge_S, \wedge_P .

4. Interaction-Sensitive Fuzzy Measure and its Use in Fuzzy Integral

Methods for constructing a team of classifiers usually try to create a team which is both both *accurate* and *diverse* [2, 3, 13]. Diversity of the classifiers in the team is a key property in classifier combining, since if the classifiers are very similar, the classifier combining cannot improve the classification quality.

Fuzzy measures represent a convenient tool to work with the diversity of the team. As $\mu(A_{<i>})$ are computed for $i = r, \dots, 1$, i.e., in i -th step, classifier $\phi_{<i>}$ is added to the set of classifiers $A_{<i+1>} = \{\phi_{<i+1>}, \dots, \phi_{<r>}\}$, we can influence the increase of the fuzzy measure – if $\phi_{<i>}$ is similar to the classifiers in $A_{<i+1>}$, the increase in the fuzzy measure should be small (since the importance of the set $A_{<i>}$ should be similar to the importance of the set $A_{<i+1>}$), and if $\phi_{<i>}$ is not similar to the classifiers in $A_{<i+1>}$, the increase of the fuzzy measure should be large.

\perp -decomposable fuzzy measures (and in particular additive measures and Sugeno λ -measure) cannot model such interactions between the classifiers, because they are defined only using the fuzzy densities and a fixed \perp . Therefore, we propose an *Interaction-Sensitive Fuzzy Measure* (ISFM), which incorporates the similarities of the classifiers in the team, defined using the following recursive definition.

Definition 13 Let $\mathcal{U} = \{u_1, \dots, u_r\}$ be a universe, let S be a similarity w.r.t. a t -norm \wedge , $s_{i,j} = S(u_i, u_j)$, let $\kappa_i \in [0, 1]$, $i = 1, \dots, r$ denote the importance (weight) of u_i , and let $A_{<i>} = \{u_{<i>}, \dots, u_{<r>}\}$,

$A_{\langle r+1 \rangle} = \emptyset$, where $\langle \cdot \rangle$ denotes index ordering according to some $f : \mathcal{U} \rightarrow [0, 1]$, such that $0 \leq f_{\langle 1 \rangle} \leq \dots \leq f_{\langle r \rangle} \leq 1$.

Let $\tilde{\mu} : \mathcal{P}(\mathcal{U}) \rightarrow \mathbf{R}^+$, such that

$$\tilde{\mu}(\emptyset) = 0 \quad (13)$$

$$\tilde{\mu}(A_{\langle r \rangle}) = \tilde{\mu}(\{u_{\langle r \rangle}\}) = \kappa_{\langle r \rangle} \quad (14)$$

$$\tilde{\mu}(A_{\langle i \rangle}) = \tilde{\mu}(\{u_{\langle i \rangle}, \dots, u_{\langle r \rangle}\}) = \quad (15)$$

$$= \tilde{\mu}(A_{\langle i+1 \rangle}) + (1 - \max_{k=i+1}^r s_{\langle i \rangle, \langle k \rangle}) \kappa_{\langle i \rangle} \quad (16)$$

$$\text{for } i = r-1, \dots, 1, \quad (17)$$

and $\forall X \subseteq \mathcal{U}$, $X \neq A_{\langle i \rangle}$, $i = 1, \dots, r$,

$$\tilde{\mu}(X) = \tilde{\mu}(A_{\langle q \rangle}), \quad (18)$$

where $q = \min\{i = r+1, \dots, 1 \mid A_{\langle i \rangle} \subseteq X\}$.

The mapping $\mu^{(I)} : \mathcal{P}(\mathcal{U}) \rightarrow [0, 1]$, defined as

$$\mu^{(I)}(X) = \frac{\tilde{\mu}(X)}{\tilde{\mu}(A_{\langle 1 \rangle})} = \frac{\tilde{\mu}(X)}{\tilde{\mu}(\mathcal{U})}, \quad (19)$$

is called an Interaction-Sensitive Fuzzy Measure (ISFM) on \mathcal{U} with respect to f .

For the fuzzy integration itself, only the values for $A_{\langle i \rangle}$, $i = 1, \dots, r$ (15-17) are needed, the remaining values (18) represent an extension to the whole power set and are needed only for $\mu^{(I)}$ to be properly defined. (19) represents a normalization of $\tilde{\mu}$ to $[0, 1]$.

The definition is general and can be used also in other applications than classifier combining. In classifier combining, $\mathcal{U} = \Gamma$ is the set of classifiers, $\kappa_i = \kappa_{\phi}(\vec{x})$ are the classification confidences, $f = \Gamma_{*,j}$ is the j -th column of the decision profile, and S denotes the similarity of classifiers (12). The following proposition shows that $\mu^{(I)}$ is well-defined.

Proposition 1 $\mu^{(I)}$ is a fuzzy measure on \mathcal{U} .

Proof: The boundary conditions follow directly from the definition of $\mu^{(I)}$. Let $X \subseteq Y \subseteq \mathcal{U}$. Then $q_X = \min\{i = r+1, \dots, 1 \mid A_{\langle i \rangle} \subseteq X\} \geq q_Y = \min\{i = r+1, \dots, 1 \mid A_{\langle i \rangle} \subseteq Y\}$, and thus, $\mu^{(I)}(X) = \mu^{(I)}(A_{\langle q_X \rangle}) \leq \mu^{(I)}(A_{\langle q_Y \rangle}) = \mu^{(I)}(Y)$, which proves the monotonicity. ■

In (16), $\max_{k=i+1}^r s_{\langle i \rangle, \langle k \rangle}$ incorporates the diversity of the team of classifiers into the fuzzy measure. The following proposition shows that if for some i ,

the i -th classifier is totally similar to some other classifier in $A_{\langle i+1 \rangle}$, then $\mu^{(I)}$ does not increase, and if it is totally unsimilar to all classifiers in $A_{\langle i+1 \rangle}$, the increase in the fuzzy measure is maximal.

Proposition 2 Let $\mu^{(I)}$ be an ISFM on \mathcal{U} w.r.t. $f : \mathcal{U} \rightarrow [0, 1]$, and let $i \in \{1, \dots, r-1\}$. Then the following holds

$$1. \exists k \in \{i+1, \dots, r\} \quad s_{\langle i \rangle, \langle k \rangle} = 1 \Rightarrow \mu^{(I)}(A_{\langle i \rangle}) = \mu^{(I)}(A_{\langle i+1 \rangle})$$

$$2. \forall k \in \{i+1, \dots, r\} \quad s_{\langle i \rangle, \langle k \rangle} = 0 \Rightarrow \mu^{(I)}(A_{\langle i \rangle}) = \mu^{(I)}(A_{\langle i+1 \rangle}) + \kappa_{\langle i \rangle} / \tilde{\mu}(\mathcal{U})$$

Proof: Trivially from (16) and (19). ■

The following proposition describes an extreme case, in which all the classifiers are totally similar (the measure in the integral behaves like a constant measure and Choquet and Sugeno integrals reduce to the maximum value).

Proposition 3 Let $\mu^{(I)}$ be an ISFM on \mathcal{U} w.r.t. $f : \mathcal{U} \rightarrow [0, 1]$, $f(u_i) = f_i$, and let $\forall i, j \in \{1, \dots, r\}$, $i \neq j$, $s_{i,j} = 1$. Then $\forall X \subseteq \mathcal{U}$

$$1. \forall k \in \{1, \dots, r\} \quad \mu^{(I)}(A_{\langle k \rangle}) = 1$$

$$2. \exists k \in \{1, \dots, r\} \quad A_{\langle k \rangle} \subseteq X \Rightarrow \mu^{(I)}(X) = 1$$

$$3. \forall k \in \{1, \dots, r\} \quad A_{\langle k \rangle} \not\subseteq X \Rightarrow \mu^{(I)}(X) = 0$$

$$4. (C) \int f d\mu^{(I)} = (S) \int f d\mu^{(I)} = \max_{i=1}^r f_i$$

Proof: (1) follows directly from (15-17) and (19); (2), (3) from (18) and (4) is an application of the measure to the definition of Choquet and Sugeno integrals. ■

Another extreme case is that all the classifiers are totally unsimilar (the measure in the integral behaves like an additive measure and the Choquet integral reduces to the weighted mean).

Proposition 4 Let $\mu^{(I)}$ be an ISFM on \mathcal{U} w.r.t. $f : \mathcal{U} \rightarrow [0, 1]$, $f(u_i) = f_i$, and let $\forall i, j \in \{1, \dots, r\}$, $i \neq j$, $s_{i,j} = 0$. Then the following holds:

$$1. \forall k \in \{1, \dots, r\} \quad \mu^{(I)}(A_{\langle k \rangle}) = \frac{\sum_{i=k}^r \kappa_{\langle i \rangle}}{\sum_{i=1}^r \kappa_{\langle i \rangle}} =$$

$$2. (C) \int f d\mu^{(I)} = \frac{\sum_{\langle I \rangle} f_{\langle I \rangle} \kappa_{\langle I \rangle}}{\sum_{\langle I \rangle} \kappa_{\langle I \rangle}}$$

Proof: (1) follows directly from (15-17) and (19). (2) is an application of the measure to the definition of the Choquet integral. ■

5. Experiments

To experimentally compare the ISFM-based approach with the Sugeno λ -measure approach, we designed three different classifier systems:

- Random Forest ensemble [16]. In our experiments, we used $r = 20$ trees.
- Ensemble of k-Nearest neighbor classifiers [17] created by bagging [14]. In our experiments, we used $r = 20$ classifiers in the team with $k = 5$.
- Ensemble of Quadratic discriminant classifiers [17] created by the multiple feature subset method [18]. Each classifier was trained only on a subset of features. For datasets with $n \leq 5$ dimensions, all possible subsets (feature combinations) in the MFS were used. For higher dimensional datasets, 32 subsets of features were selected by bagging.

To compute the classification confidence, we used the ELA method (2). The number of neighbors was set based on the size of the dataset to $k = 5$ (≤ 500 patterns), $k = 10$ (501 – 1000 patterns), or $k = 20$ (> 1000 patterns). The values of the parameters were set based on preliminary testing, no optimization or fine-tuning was done. As aggregation operators, we used the following

- Weighted mean – representing the baseline (special case of the Choquet integral with additive measure)
- Choquet integral with the λ -measure
- Choquet integral with the ISFM
- Sugeno integral with the λ -measure
- Sugeno integral with the ISFM
- Single best (for reference) – mean error rate of the classifier with lowest error rate selected in each crossvalidation run, representing the “worst-case” scenario
- Oracle (for reference) – the theoretical “best-case” scenario, which, for a given pattern, gives correct prediction if and only if any of the classifiers in the team gives correct prediction

The methods were implemented in the Java programming language and the experiment was performed on 7 artificial and 19 real-world datasets with varying size, dimensionality, and class count (due to numerical instabilities of the QDC model, we had to leave out three real-world datasets for the QDC ensemble). The properties of the datasets are shown in Table 1. We used 10-fold cross-validation to measure the performance of the methods (8 folds for training set, 9th fold for validation set, 10th fold for testing set, with cyclic shift). The validation set was used to compute the classification confidence and the similarity of the classifiers in the team, and the testing set was used to compare the results of the methods. The mean value and standard deviation of the error rate were measured. We also measured statistical significance of the results (at 5% confidence level by the analysis of variance using Tukey-Kramer method).

Table 1: Properties of the datasets used in the experiments.

Dataset	ref.	size	classes	dimensions
Artificial				
clouds	[25]	5000	2	2
concentric	[25]	2500	2	2
gauss 3D	[25]	5000	2	3
gauss 8D	[25]	5000	2	8
ringnorm	[26]	3000	2	20
twonorm	[26]	3000	2	20
waveform	[26]	5000	3	21
Real-world				
balance	[26]	625	3	4
breast	[26]	699	2	9
glass	[26]	214	7	9
iris	[26]	150	3	4
letter-recg.	[26]	20000	26	16
pendigits	[26]	10992	10	16
phoneme	[25]	5427	2	5
pima	[26]	768	2	8
poker	[26]	4828	3	10
satimage	[25]	6435	6	4
segmentation	[26]	2310	7	16
sonar	[26]	208	2	60
texture	[25]	5500	11	10
transfusion	[26]	748	2	4
vehicle	[26]	946	4	18
vowel	[26]	990	11	10
wine	[26]	178	3	13
wineq-red	[26]	1600	3	11
wineq-white	[26]	4898	3	11
yeast	[26]	1484	4	8

Table 2: Random Forest: The i, j -th element of the table shows the number of datasets in which method i obtained lower mean error rate than method j . The number in parentheses, if present, shows the number of datasets for which the improvement was statistically significant (excluding Oracle). The last column shows the number of datasets for which a given method was better than all the other methods (excluding Oracle).

↓ superior to →	SB	WMean	CI- λ	CI-ISFM	SI- λ	SI-ISFM	Oracle	all
SB	-	0	1 (1)	0	1 (1)	0	0	0
WMean	26 (16)	-	12 (3)	3	12 (5)	5	0	1
CI- λ	25 (16)	14	-	5	14	8	0	1
CI-ISFM	26 (18)	23	21 (5)	-	19 (5)	16	0	11
SI- λ	25 (17)	14	12	6	-	8	0	4
SI-ISFM	26 (18)	21	18 (3)	10	18 (4)	-	0	9
Oracle	26	26	26	26	26	26	-	26

Table 3: k-NN ensemble: The i, j -th element of the table shows the number of datasets in which method i obtained lower mean error rate than method j . The number in parentheses, if present, shows the number of datasets for which the improvement was statistically significant (excluding Oracle). The last column shows the number of datasets for which a given method was better than all the other methods (excluding Oracle).

↓ superior to →	SB	WMean	CI- λ	CI-ISFM	SI- λ	SI-ISFM	Oracle	all
SB	-	7	3	2	2	2	0	0
WMean	19 (1)	-	3	4	3	3	0	0
CI- λ	23 (3)	23	-	10	17	11	0	9
CI-ISFM	24 (6)	22 (3)	16	-	19 (1)	14	0	10
SI- λ	25 (2)	23 (1)	11	7	-	8	0	2
SI-ISFM	24 (8)	23 (3)	15	12	18 (1)	-	0	7
Oracle	26	26	26	26	26	26	-	26

Table 4: QDC ensemble: The i, j -th element of the table shows the number of datasets in which method i obtained lower mean error rate than method j . The number in parentheses, if present, shows the number of datasets for which the improvement was statistically significant (excluding Oracle). The last column shows the number of datasets for which a given method was better than all the other methods (excluding Oracle).

↓ superior to →	SB	WMean	CI- λ	CI-ISFM	SI- λ	SI-ISFM	Oracle	all
SB	-	8	6	4	7	3	0	1
WMean	15 (8)	-	12 (2)	2	13 (2)	4	0	0
CI- λ	17 (6)	11	-	5	14 (1)	7	0	3
CI-ISFM	19 (8)	21 (4)	19 (5)	-	19 (5)	11	0	10
SI- λ	16 (8)	10	9	4	-	7	0	1
SI-ISFM	20 (9)	19 (4)	16 (5)	12	16 (5)	-	0	8
Oracle	23	23	23	23	23	23	-	23

To compare the methods in general, we measured the number of datasets in which a given method outperformed other methods, the results are shown in Tables 2–4.

As our main goal in this experiment was to compare ISFM with Sugeno λ -measure, we can say the following. For the Random Forests with Choquet integral, ISFM outperformed λ -measure on 21 datasets (5 times significant), with Sugeno integral on 18 datasets (4 times significant), out of 26 datasets total. For the k-NN ensemble with Choquet integral, ISFM outperformed λ measure on 16 datasets (none significant), with Sugeno integral on 18 datasets (once significant), out of 26 datasets total. For the QDC ensemble with Choquet integral, ISFM outperformed λ measure on 19 datasets (5 times significant), with Sugeno integral on 16 datasets (6 times significant), out of 23 datasets total.

Generally speaking, fuzzy integral with ISFM usually outperformed λ -measure in most cases (sometimes statistically significantly, but no significant outperforming of λ -measure over ISFM occurred). The Choquet integral obtained slightly better results than the Sugeno integral, and the Choquet integral with ISFM was the most successful aggregation scheme in these experiments. Another interesting result is that while both Choquet and Sugeno integrals with ISFM outperformed the Weighted Mean, this is not true for the case of Sugeno λ -measure – in most cases, both Choquet and Sugeno integrals with λ -measure obtained comparable or significantly worse results than the Weighted mean.

6. Conclusion

In this paper, we have summarized how the fuzzy integral can be used as an aggregation operator in dynamic classifier systems. We have discussed that symmetric, and \perp -decomposable fuzzy measures are not appropriate for using in classifier combining with fuzzy integral and we have introduced an interaction-sensitive fuzzy measure (ISFM), which tries to overcome the weaknesses of these methods. IFSM, designed specifically for the use in classifier aggregation, provides a convenient tool for representing the diversity of the team of classifiers, and, when used in the fuzzy integral, the aggregation can incorporate the classifier predictions, the classification confidences, and also the diversity of the team. Our experiments with three different dynamic classifier systems with the Choquet and Sugeno integrals on 26 datasets show that the ISFM outperforms the Sugeno λ -measure, which is used most often in the literature in connection with the fuzzy integral.

References

- [1] D. Štefka and M. Holeňa, “Dynamic classifier aggregation using fuzzy integral with interaction-sensitive fuzzy measure,” in *Proceedings of the 10th International Conference on Intelligent Systems Design and Applications, ISDA 2010, November 29 - December 1, 2010, Cairo, Egypt*, pp. 225–230, IEEE, 2010.
- [2] L. I. Kuncheva, *Combining Pattern Classifiers: Methods and Algorithms*. Wiley-Interscience, 2004.
- [3] L. Rokach, “Taxonomy for characterizing ensemble methods in classification tasks: A review and annotated bibliography,” *Comput. Stat. Data Anal.*, Vol. 53, No. 12, pp. 4046–4072, 2009.
- [4] D. Ruta and B. Gabrys, “An overview of classifier fusion methods,” *Computing and Information Systems*, Vol. 7, pp. 1–10, 2000.
- [5] D. Štefka and M. Holeňa, “Dynamic classifier systems and their applications to random forest ensembles,” in *Proceedings of the ICANNGA 2009 Ninth International Conference on Adaptive and Natural Computing Algorithms, Kuopio, Finland*, vol. 5495 of *Lecture Notes in Computer Science*, p. 458–468, Springer, 2009.
- [6] G. Giacinto and F. Roli, “Dynamic classifier selection based on multiple classifier behaviour,” *Pattern Recognition*, Vol. 34, No. 9, pp. 1879–1881, 2001.
- [7] A. H. R. Ko, R. Sabourin, and A. S. Britto, Jr., “From dynamic classifier selection to dynamic ensemble selection,” *Pattern Recogn.*, Vol. 41, No. 5, pp. 1718–1731, 2008.
- [8] K. Woods, J. W. Philip Kegelmeyer, and K. Bowyer, “Combination of multiple classifiers using local accuracy estimates,” *IEEE Trans. Pattern Anal. Mach. Intell.*, Vol. 19, No. 4, pp. 405–410, 1997.
- [9] A. Tsymbal, M. Pechenizkiy, and P. Cunningham, “Dynamic integration with random forests,” in *ECML (J. Fürnkranz, T. Scheffer, and M. Spiliopoulou, eds.)*, Vol. 4212 of *Lecture Notes in Computer Science*, pp. 801–808, Springer, 2006.
- [10] V. Torra and Y. Narukawa, *Modeling Decisions: Information Fusion and Aggregation Operators*. Springer, 2007.
- [11] M. Grabisch and H. T. Nguyen, *Fundamentals of Uncertainty Calculi with Applications to Fuzzy Inference*. Norwell, MA, USA: Kluwer Academic Publishers, 1994.

- [12] L. I. Kuncheva, "Fuzzy versus nonfuzzy in combining classifiers designed by boosting," *IEEE Transactions on Fuzzy Systems*, Vol. 11, No. 6, pp. 729-741, 2003.
- [13] L. I. Kuncheva and C. J. Whitaker, "Measures of diversity in classifier ensembles," *Machine Learning*, Vol. 51, pp. 181-207, 2003.
- [14] L. Breiman, "Bagging predictors," *Machine Learning*, Vol. 24, No. 2, pp. 123-140, 1996.
- [15] Y. Freund and R. E. Schapire, "Experiments with a new boosting algorithm," in *International Conference on Machine Learning*, pp. 148-156, 1996.
- [16] L. Breiman, "Random forests," *Machine Learning*, Vol. 45, No. 1, pp. 5-32, 2001.
- [17] R. O. Duda, P. E. Hart, and D. G. Stork, *Pattern Classification (2nd Edition)*. Wiley-Interscience, 2000.
- [18] S. D. Bay, "Nearest neighbor classification from multiple feature subsets," *Intelligent Data Analysis*, Vol. 3, No. 3, pp. 191-209, 1999.
- [19] D. J. Hand, *Construction and Assessment of Classification Rules*. Wiley, 1997.
- [20] S. J. Delany, P. Cunningham, D. Doyle, and A. Zamolotskikh, "Generating estimates of classification confidence for a case-based spam filter," in *Case-Based Reasoning, Research and Development, 6th Int. Conf., ICCBR 2005, Chicago, USA* (H. Muñoz-Avila and F. Ricci, eds.), Vol. 3620 of *LNCS*, pp. 177-190, Springer, 2005.
- [21] L. I. Kuncheva, J. C. Bezdek, and R. P. W. Duin, "Decision templates for multiple classifier fusion: an experimental comparison," *Pattern Recognition*, Vol. 34, No. 2, pp. 299-314, 2001.
- [22] T. Murofushi and M. Sugeno, "Fuzzy t-conorm integral with respect to fuzzy measures: Generalization of Sugeno integral and Choquet integral," *Fuzzy Sets and Systems*, Vol. 42, No. 1, pp. 57-71, 1991.
- [23] E. P. Klement, R. Mesiar, and E. Pap, "A universal integral as common frame for choquet and sugeno integral," *Trans. Fuz Sys.*, Vol. 18, pp. 178-187, 2010.
- [24] P. Hájek, *Metamathematics of Fuzzy Logic*. Trends in Logic, Kluwer, 2001.
- [25] UCL MLG, "Elena database," 1995. <http://www.dice.ucl.ac.be/mlg/?page=Elena>.
- [26] C. B. D.J. Newman, S. Hettich and C. Merz, "UCI repository of machine learning databases," 1998. <http://www.ics.uci.edu/mllearn/MLRepository.html>.

The Heritage Trust Model

Post-Graduate Student:

ING. PAVEL TYL

Faculty of Mechatronics, Informatics and Interdisciplinary Studies
Technical University of Liberec
Hájkova 6
461 17 Liberec 1, CZ

pavel.tyl@tul.cz

Supervisor:

ING. JÚLIUS ŠTULLER, CSC.

Institute of Computer Science of the ASCR, v. v. i.
Pod Vodárenskou věží 271/2
182 07 Prague 8, CZ

stuller@cs.cas.cz

Field of Study:
Technical Cybernetics

This project is partly realized under the state subsidy of the Czech Republic within the research and development project "Advanced Remediation Technologies and Processes Center" 1M0554 – Programme of Research Centers PP2-DP01 supported by the Ministry of Education.

Abstract

Trust management systems have been proposed to address joyless security in open and distributed environments (Web, Semantic Web, Peer-to-peer networks, etc.). A user usually spent a lot of time by building her/his reputation and by creating a network of trusted/distrusted users. Without possibility of seamless transfer from one trust management system to another, a user is forced to build a new reputation/network of trusted users again. This problem will become even more severe, as many current systems using trust as a key factor influencing ability to communicate within a group of users will be outdated and some of them even down.

The paper presents a specification of the seamless transfer problem and it also introduces a solution – the Heritage Trust Model based on dynamic graphs and ontologies.

From our point of view, the main property missing in known trust management systems is the ability to store evolution of relationships/reputations between users. Thus, we propose a model that is able to store the whole evolution of reputation/social relationships between users.

The following itemization gives the basics for the proposal:

- Each user in the system has its own viewpoint of her/his vicinity. It means that relationships are not symmetric and a user may not be aware of what the others think of her/his. This is important as the same peculiarity exists in the real human societies.
- A particular relationship/trust between users has different meaning based on the context.
- Each user is responsible for its own network. Each user may have its own preferences, aims and wills.

The Heritage Trust Model aims to overcome main insufficiencies of current trust management systems. As the most severe we have identified impossibility to transfer reputation/trust relationships from one system to another, as well as the impossibility to compare trust management systems using different notion of trust.

To overcome this issues we have proposed a trust model, that is based on idea of maintaining history (evolution) of relationships between users with addition of ontology for description of relationships between users. Using ontology roles as a weight assigned to a relationship allows transfer as well as comparison of trust management systems. Storing evolution of relationships enables also fault tolerance – users are able to learn a lesson from their own mistakes.

As the future work, we are going to implement the Heritage Trust Model for storing evolution of relationships and verify expected space complexity. The next step would be an implementation of an ontology designed/extended to be appropriate to model whole complexity of human relationships and experimental comparison of selected trust management systems with use of the Heritage Trust Model.

My contribution was to propose an ontology for the Heritage Trust Model with a possibility of collaboration with existing ones.

This work was published and presented: ŠPÁNEK, ROMAN – TYL, PAVEL. The Heritage Trust Model. In: Proceedings of International Conference on Digital Information and Communication Technology and its Applications (DICTAP 2011), (Eds. H. Cherifi, Zain, J. M. Zain, E. El-Qawasmeh), Communications in Computer and Information Science (CCIS), Part II, Vol. 167, pp. 307–321, Springer 2011. ISBN 978-3-642-22026-5. Presented at: International Conference on Digital Information and Communication Technology and its Applications (DICTAP 2011), 21.–23. 6. 2011, Dijon, France.

Special Types of Filters on Algebras of Rasiowa Implicative Logics

Post-Graduate Student:

MGR. MARTIN VÍTA

Institute of Computer Science of the ASCR, v. v. i.
Pod Vodárenskou věží 2
182 07 Prague 8, CZ
vita@cs.cas.cz

Supervisor:

ING. PETR CINTULA, PH.D.

Institute of Computer Science of the ASCR, v. v. i.
Pod Vodárenskou věží 2
182 07 Prague 8, CZ
cintula@cs.cas.cz

Field of Study:
Algebra, teorie čísel a matematická logika

This work is based on results presented on EUSFLAT–LFA 2011 conference.
It has been published in the proceedings of this conference.
This work is supported by grant P401/10/0146 of the Grant Agency of the Czech Republic.

Abstract

This contribution provides a generalization of many particular results about special types of filters, e. g. (positive) implicative, fantastic and boolean filters on algebras of Rasiowa implicative logics. Our approach uses the framework of Abstract Algebraic Logic (AAL) and is based on the close connection between the filter-defining conditions and alternative axiomatizations of the logics involved.

The key notion of this work is the notion of R -L-filter, which arises from the standard definition of L-filter in AAL, and allows us to deal with L-filters satisfying given special conditions in a uniform way.

We have identified four main kinds of theorems proved in several papers published in the last five years and we have formulated general theorems which – together with straightforward syntactical proofs – yield the majority of published results as their direct consequences.

References

- [1] W. J. Blok and D. Pigozzi, *Algebraizable Logics*, volume 396 of *Memoirs of the American Mathematical Society*. American Mathematical Society, Providence, RI, 1989.
- [2] P. Cintula and C. Noguera, Implicational (semilinear) logics I: Basic notions and hierarchy. *Archive for Mathematical Logic*, 49(4):417-446, 2010.
- [3] J. Czelakowski, *Protoalgebraic Logics*, volume 10 of *Trends in Logic*. Kluwer, Dordrecht, 2001.
- [4] J. M. Font, R. Jansana, and D. Pigozzi, A survey of Abstract Algebraic Logic. *Studia Logica*, 74(1–2, Special Issue on Abstract Algebraic Logic II):13-97, 2003.
- [5] N. Galatos, P. Jipsen, T. Kowalski, and H. Ono, *Residuated Lattices: An Algebraic Glimpse at Substructural Logics*, volume 151 of *Studies in Logic and the Foundations of Mathematics*. Elsevier, Amsterdam, 2007.
- [6] P. Hájek, *Metamathematics of Fuzzy Logic*, Vol. 4 of *Trends in Logic*. Kluwer, Dordrecht, 1998.
- [7] M. Haveski, A. Saeid, and E. Eslami, Some types of filters in BL-algebras. *Soft Computing*, 10:657-664, 2006.
- [8] U. Höhle, Commutative, residuated lmonoids. In Ulrich Höhle and Erich Peter Klement, editors, *Non-Classical Logics and Their Applications to Fuzzy Subsets*, pp. 53-106. Kluwer, Dordrecht, 1995.
- [9] M. Kondo and W. A. Dudek, Filter theory of BL-algebras. *Soft Computing*, 12:419-423, 2008.
- [10] J. Rachůnek and D. Šalounová, Classes of filters in generalizations of commutative fuzzy structures. *Acta Universitatis Palackianae Olomucensis. Facultas Rerum Naturalium. Mathematica*, 48(1):93-107, 2009.
- [11] H. Rasiowa, *An Algebraic Approach to Non-Classical Logics*. North-Holland, Amsterdam, 1974.
- [12] Y. Zhu and Y. Xu, On filter theory of residuated lattices. *Information Sciences*, 180(19):3614-3632, 2010.

Strukturální a lexikální analýza lékařských zpráv

doktorand:

ING. KAREL ZVÁRA

Oddělení medicínské informatiky
Ústav informatiky AV ČR, v. v. i.
Pod Vodárenskou věží 2
182 07 Praha 8

zvava@euromise.cz

školitel:

DOC. ING. VOJTĚCH SVÁTEK, DR.

Vysoká škola ekonomická v Praze
nám. W. Churchilla 4
130 67 Praha 3

svatek@vse.cz

obor studia:

Biomedicínská informatika

Abstrakt

Článek pojednává o výsledcích strukturální a lexikální analýzy lékařských zpráv. V této části zpracování lékařských zpráv jsem prakticky ověřil použitelnost dostupných klasifikačních systémů i obecných nástrojů a databází.

1. Vědecká otázka a očekávaný přínos

Hlavním cílem práce je zjištění specifických vlastností českých lékařských zpráv z hlediska možnosti extrahovat z nich konkrétní údaje. Realizace cíle předpokládá splnění dílčích cílů:

1. Zodpovědět otázku „Které vlastnosti českých lékařských zpráv působí největší problémy v jednotlivých nestatistických fázích zpracování přirozeného jazyka?“. Jednotlivými fázemi přitom jsou strukturální analýza, lexikální analýza a slovní rozbor.
2. Navrhnout základní postup pro analýzu česky psaných lékařských zpráv.
3. Pomocí vlastní implementace s využitím externích nástrojů ověřit navržený postup pro analýzu česky psaných lékařských zpráv a základní postup i výsledky publikovat.

Ověřovanou hypotézu jsem formuloval takto: „Z odborných lékařských zpráv psaných v českém jazyce lze pod supervizí odborníka a za použití technologií pro zpracování přirozeného jazyka získávat specifikované odborné informace, například seznam známých alergických reakcí či výsledky biochemických vyšetření.“

Přínosem výzkumu by mělo být přiblížení či přímo implementace nástrojů pro asistovanou extrakci informací

z lékařských textů psaných v českém jazyce. Extrahované informace lze následně využít pro potřeby elektronické zdravotnické dokumentace nebo pro využití společně s dalšími technologiemi (např. jako vstupní data do automatů provádějících formalizovanou lékařskou doporučení).

Tématu extrakce informací z lékařských zpráv se věnoval Semecký, který v [1] uvedl důvody pro které se zdá, že lingvistická analýza lékařských zpráv nemůže být úspěšná. Semecký v [1] používal především regulárních výrazů pro extrakci číselných hodnot. Na práci [1] navázal Smatana v práci [2], rozšířil přístup Semeckého o lingvistickou analýzu a došel k mírně lepším výsledkům.

Od mé práce očekávám další rozšíření, především vytvoření pracovního číselníku pro kardiologii navázaného na koncepty UMLS [3] a jeho aplikování na dostupné lékařské zprávy.

2. České lékařské zprávy

České lékařské zprávy jsou vesměs textové dokumenty. Jejich obsah i forma jsou upraveny zákonem č. 20/1966 Sb ve znění pozdějších předpisů „o péči o zdraví lidu“ [4] (především v § 67b) a vyhláškou č. 385/2006 Sb. ve znění pozdějších předpisů „o zdravotnické dokumentaci“ [5] (vyhláška je závazná, neboť úpravu umožňuje § 67b odstavec 19 zákona).

Styl formátování lékařských zpráv se liší i přesto, že vyhláška o zdravotnické dokumentaci taxativně vyměňuje obsah zdravotnické dokumentace pro její jednotlivé druhy. Lékaři záznamy ve zdravotnické dokumentaci tvoří obvykle podle šablony, resp. upravením poslední zprávy stejného druhu u stejného pacienta. Takový postup totiž lékařům šetří čas; jednotlivé druhy zpráv obvykle musejí obsahovat velké množství s časem

se jen málo měnících informací jako je identifikace zdravotnického zařízení, administrativní údaje o pacientovi (datum narození, číslo pojištěnce, adresa pobytu), část diagnostické rozvahy (především dlouhodobé diagnózy a známé alergie) a dlouhodobou medikaci (např. léky pro snižování krevního tlaku).

Pro výzkum mám k dispozici sady zpráv ze dvou zdrojů. Při praktickém ověřování postupů proto data z jednoho zdroje využívám pro nastavení ověřovacího pokusu (např. pro vytvoření slovníku) a data z druhého zdroje využívám pro zjištění úspěšnosti metody.

3. Strukturální analýza

Strukturální analýza představuje první fázi zpracování textu. Úkolem strukturální analýzy je tokenizace, rozdělení do vět a případně také do vyšších struktur (např. odstavců).

Obvyklým postupem pro strukturální analýzu je rozdělení vstupního textu podle speciálních znaků, tedy symbolů ukončujících slova (mezera, čárka, středník), věty (tečka, otazník, vykřičník). České lékařské zprávy jsou však značně netypickými texty. Obsahují ohromně velké množství zkrácených slov a zkratk.

Při použití běžného přístupu ke strukturální analýze jsem velmi brzy zjistil, že v českých lékařských zprávách je význam speciálních znaků odvoditelný až z jejich okolí. Čeština totiž patří k jazykům s volným pořadím slov. Způsob zápisu lékařských zpráv není striktně standardizován [6].

Ukázka textu v části objektivní nález: „*Akce pravidelná, klidná, 2 ohr. ozvy. Břicho klidné, játra, sleziona nezv., tapot. nebol., jizva po CHE keloidní. Akne po trupu. DK bez otoků a varixů.*“

Výše uvedená věta ukazuje několik typických vlastností českých lékařských zpráv:

- Většina vět neobsahuje sloveso, protože je zřejmé z kontextu. V první větě navíc chybí určení předmětu – jde o akci srdce.
- Druhá věta obsahuje překlep („sleziona“ namísto „slezina“), lékařské zprávy jsou protkány překlepy.
- V uvedených čtyřech větách jsou čtyři zkrácená slova a dvě zkratky.

Problematika zkracování slov není typická jen pro české lékařské zprávy. [7] uvádí, že lékaři jiných odborností

jsou schopni správně interpretovat jen asi polovinu užívaných zkratk a zkrácených slov. Podobně potíže uvádí také [8] a z oboru práva též [9].

Některé části lze správně identifikovat až z kontextu. Z toho důvodu jsem se rozhodl ve fázi strukturální analýzy standardizovat konce řádků (CR+LF na CR) a transformovat vstupní text do řetězce objektů (nazývám je kontejnery), přičemž po skončení průběhu v této fázi jsou objekty následujících druhů:

- řetězec alfanumerických znaků (po sobě jdoucích),
- jiný znak (u toho je možné uvést kolikrát za sebou se stejný znak opakuje).

Na získaný řetězec objektů aplikuji metody, které z podřetězce odvozují další druhy objektů. Metody aplikuji i na podřetězce tvořené z takto získaných nových objektů. Tímto způsobem identifikuji:

- numerické řetězce (celé číslo bez znaménka) - číslo,
- separovaná čísla (vždy kombinace: *číslo [separátor číslo]+*),
- datum ve formátu d.m.r (s mezerami či bez mezer za tečkami),
- rodné číslo (kontrola existence data, kontrola součtem u 10-ciferných) – s lomítkem i bez lomítka.

4. Lexikální analýza

Úkolem lexikální analýzy je identifikovat jednotlivé základní části textu, tedy slova, hodnoty a podobně. Lékařské zprávy jsou zvláštním druhem volného textu. Hledal jsem proto slovník, který bych mohl využít pro identifikaci slova.

Obecné české korpusy považuji pro tento účel za nevhodné, protože jsou vytvářeny z jiného druhu projevů, obvykle z prózy či novinových článků. Při hledání jsem zjistil, že databáze pro volně šiřitelný slovník pro automatickou kontrolu pravopisu iSpell, je GNU licencí (zajišťující použitelnost pro vědecké účely), a že jeho autor myslel na možné další využití slovníku. Slova tohoto slovníku jsou uspořádána do několika různých souborů, je tak snadno možné identifikovat velké množství jmen a názvů. Pravidla, jejichž využitím iSpell generuje další tvary a odvozená slova, jsou zapsána tak, že odpovídají tvorbě jednotlivých slovních druhů.

V lékařských zprávách je velké množství odborných termínů. U nezkrácených českých slov se mi pomocí rozšířeného slovníku iSpellu podařilo identifikovat slovní druh bez závažnějších problémů i když v mnoha případech nikoliv jednoznačně. Vlastní jména totiž často odpovídají obecnému podstatnému nebo přídavnému jménu (např. Dlouhý či Noha). Pokud jsou taková slova na začátku věty, v části lexikální analýzy není možné řádně klasifikovat slovo.

Pozornost jsem dále upřel na snahu identifikovat odborné termíny, neboť jedním z cílů je zjištění možnosti získat ze zprávy anamnestické informace, především informace o diagnózách, alergiích a výsledcích biochemických vyšetření. Našel jsem celkem tři klasifikační systémy, které by bylo možné využít pro identifikaci jednotlivých odborných termínů.

Prvním testovaným systémem byla anglická verze klasifikačního systému SNOMED CT [10]. Pomocí tohoto klasifikačního systému se podařilo identifikovat termíny, které nebyly zkrácené, a které mají stejné znění v českém i v anglickém jazyce. Vzhledem k odbornosti vstupních lékařských zpráv (kardiologie), tak šlo o tyto konkrétní termíny: „diabetes mellitus“ (SNOMED CT 73211009) a jednotku mmHg (SNOMED CT 259018001). Česká verze SNOMED CT neexistuje, mimo jiné proto, že ani existovat nemůže. Česká republika totiž není členem International Health Terminology Standards Development Organisation (IHTSDO), vlastníka klasifikačního systému SNOMED CT. SNOMED CT není použitelný pro identifikaci lékařských termínů ve volném textu.

Druhým testovaným klasifikačním systémem byla Mezinárodní klasifikace nemocí verze 10 (ICD10, MKN10) v české verzi [11]. Tento číselník byl velkým zklamáním, jeho překlad byl totiž vytvořen jen pro ruční vyhledávání podle kódu diagnózy. Mnoho přeložených textů je totiž složeno ze zkrácených slov, přičemž v některých případech je jedno slovo zkracováno různými způsoby. V tomto záznamu je dvakrát zkráceno slovo „diabetes“, pokaždé jinak: „Diabet.polyneuropat. při diab.“. V některých případech je text kvůli zkracování slov i obtížně čitelný: „J.deg.on.oč.víčka a periok.kr.“. Vzhledem k velmi častému zkracování slov v MKN10 tento klasifikační systém není použitelný pro identifikaci odborných termínů ve volném textu. I kdyby však slova zkrácena nebyla, vzhledem ke skutečnosti, že MKN10 obsahuje jen výčet diagnóz, nebyl by tento číselník použitelný pro využití většiny klinických termínů.

Třetím testovaným klasifikačním systémem byl bibliografický klasifikační systém Medical Subject Headings (MeSH) v české verzi [12]. Pomocí MeSH se podařilo

identifikovat průměrně cca 10 termínů na lékařskou zprávu [13]. MeSH není klinicky orientován a tomu odpovídaly také výsledky. Identifikované termíny odpovídaly především označení částí těla, v malé míře měřeným parametrům, v jednom případě diagnóze. Skutečně odborné termíny tak zůstaly neidentifikované.

5. Závěr a výhled

Jak uvádím výše, zjistil jsem, že žádný z dostupných klasifikačních systémů není využitelný pro identifikaci odborných termínů. V současné době z části zpráv vytvářím databázi v českých zpráv užívaných odborných termínů mapovaných na koncepty UMLS [3]. Jakkmile budu mít zpracovanou základní databázi, otestuji její využitelnost jejím využitím na identifikaci termínů ze všech dostupných zpráv.

Literatura

- [1] J. Semecký a J. Zvárová (školitelka), “Diplomová práce: Multimediální elektronický záznam o nemocném v kardiologii”, *Univerzita Karlova v Praze, Matematicko-fyzikální fakulta*, 2001.
- [2] P. Smatana a J. Paralič (školitel), “Diplomová práce: Spracovanie lekárskych správ pre účely analýzy a dolovania v textoch”, *Technická univerzita v Košicích, Košice*, 2005.
- [3] “Unified Medical Language System, United States National Library of Medicine”.
- [4] “Zákon č. 20/1966 Sb ve znění pozdějších předpisů, o péči o zdraví lidu”.
- [5] “Vyhláška č. 385/2006 Sb. ve znění pozdějších předpisů, o zdravotnické dokumentaci”.
- [6] P. Přečková, “Language of Czech Medical Reports and Classification Systems in Medicine”, *European Journal for Biomedical Informatics*, Vol. 9, No. 1, pp. 58-65, 2010.
- [7] K. E. Walsh and J. H. Gurwitz, “Medical Abbreviations: writing little and communicating less”, *Archives of Diseases in Childhood*, 2008.
- [8] H. Yu, G. Hripcsak, and C. Friedman, “Mapping Abbreviations to Full Forms in Biomedical Articles”, *Journal of the American Medical Informatics Association*, Vol. 9, No. 3, pp. 262-272, 2002.
- [9] Y. HaCohen-Kerner, A. Kass, and A. Peretz, “Baseline methods for automatic disambiguation of abbreviations in Jewish law documents”, *Lecture Notes in Computer Science, Advances in Natural Language Processing Baseline methods for automatic disambiguation of abbreviations in*

- Jewish law documents* , Springer, Vol. 3230, pp. 58-69, 2004.
- [10] “Systematized Nomenclature in Medicine - Clinical Terms, International Health Terminology Standards Development Organisation”.
- [11] “Mezinárodní klasifikace nemocí, Ústav zdravotnických informací a statistiky / World Health Organization”.
- [12] “Medical Subject Headings, Národní lékařská knihovna / United States National Library of Medicine”.
- [13] K. Zvára and V. Kašpar, “Identification of Units and Other Terms in Czech Medical Records”, *European Journal for Biomedical Informatics*, Vol. 9, No. 1, 2010.

Cardio Online Reader – An Easy Way to Obtain Valid Scientific Articles in Cardiology

Post-Graduate Student:

MUDR. MIROSLAV ZVOLSKÝ

Department of Medical Informatics
Institute of Computer Science of the ASCR, v. v. i.
Pod Vodárenskou věží 2
182 07 Prague 8, CZ

zvolsky@euromise.cz

Supervisor:

DOC. ING. ARNOŠT VESELÝ, CSC.

Department of Medical Informatics
Institute of Computer Science of the ASCR, v. v. i.
Pod Vodárenskou věží 2
182 07 Prague 8, CZ

vesely@pef.czu.cz

Field of Study:
Biomedical Informatics

This work was supported by the project 1M06014 of the Ministry of Education CR and the research plan AV0Z10300504.

Abstract

Searching for the clinical valid information in the large bibliographic database can be time consuming and hard work. We designed an easy-to-use web service Cardio Online Reader (COR) specialized on the topic of Cardiology. As a source we use the PubMed database adding simple filter and social functions for sharing the content.

1. Introduction

The cumulative total of journal articles exceeded 50 million in 2009 [1]. The most important free accessible resource of biomedical science articles is the PubMed database, which is one of key services provided by the National Center for Biotechnology Information (NCBI). The PubMed database contained 21067999 article citations on the 1 August 2011.

It is extremely complex problem to orientate oneself and to find desired information in this huge amount of papers. Especially it is important when searched information is clearly defined by a clinical domain, demanded time of publishing keywords or authors.

The web interface if the PubMed database [2] accessible on <http://www.ncbi.nlm.nih.gov/pubmed/> offers one html form field for searching for key terms in the database. It put the accent on search query syntax, for the definition should be defined precisely. When the search query consists of one or two key terms, the search engine returns often tens of thousand results. The result list is sorted by time in a descendent order, so the most recent articles come at first, but this order says nothing about qualitative parameters of articles.

The NCBI web pages also offers an advanced search tool for the PubMed database <http://www.ncbi.nlm.nih.gov/pubmed/advanced>. Users can define the search query in the PubMed Advanced Search in 39 parameters, which stores the PubMed database. Advanced Search saves a history of searched queries for each user. These queries can be repeatedly retrieved.

The web interface of Advanced Search is more complicated to use then one form field in the basic search. The definition of the query is more time consuming and it needs an experience with search query formulation for obtaining high-quality results. The best information sources provide relevant, valid material that can be accessed quickly and with minimal effort [3].

2. The Cardio Online Reader Web Application

Clinicians should obtain the information they want easy and quickly. Our purpose was to simplify the process of obtaining searched articles in the stressing and time lacking situation of clinical practice. We wanted to allow clinical workers without an experience with advanced database search tools to utilize the possibilities of large bibliographical databases. In the first phase we decided to limit the area of clinical domains to the Cardiology and developed the Cardio Online Reader application. This application is freely accessible on <http://neo.euromise.cz/cor>.

2.1. The Cardio Online Reader Database

The database of citations and abstracts of biomedical science articles is the main part of the Cardio Online Reader application (COR). This database uses a MySQL database engine. The main data source for our project is the PubMed database, that can be used free of charge.

The screenshot displays the COR application web interface. At the top, there is a navigation menu with 'Home', 'About', 'Contact', and 'Forum'. Below this is a search filter form with the following fields: 'Search Title, Abstract', 'Author: Roman', 'MeSH (Choose the MeSH term): Heart Failure', and 'Date and category selection: 1982-06-01 - 2011-08-04'. There are buttons for 'Apply the Filter' and 'Clear the Filter'. Below the filter form, it indicates '4 results found (showing 1 - 4) for MeSH Heart Failure'. The results list includes four articles, each with a title, authors, and a 'Published on Medline' date. The first article is 'Coronary artery bypass grafting with concomitant cardiac resynchronisation therapy in patients with ischaemic heart failure and left ventricular dyssynchrony', published on 29.7.2011. The second is 'Effects of ULTRAFiltration vs. DiureticS on clinical, biohumoral and haemodynamic variables in patients with deCompensated heart failure: the ULTRADISCO study', published on 24.6.2011. The third is 'Efficiency of intramyocardial injections of autologous bone marrow mononuclear cells in patients with ischemic heart failure: a randomized study', published on 5.10.2010. The fourth is 'Influence of digitalis on left ventricular functional response to exercise in congestive heart failure', published on 1.3.1996. Each article has a star rating and a note 'Not yet rated, be first!'. On the right side of the interface, there is a 'PubMed' search box, a 'Refer peers to the COR' section with social media sharing options, a 'Follow us' section with social media icons, and a 'MeSH cloud' section with a list of MeSH terms.

Figure 1: An example of COR application web interface showing the list of articles retrieved for parameters set in the filter form fields above.

Import of the data was realized by the query to the PubMed database defining the domain of Cardiology by using Most important MeSH terms from Cardiology.

We filtered off articles, which do not fulfil our qualitative criteria from the Evidence Based Medicine point of view. We selected only these types of articles:

- Randomized Controlled Trials,
- Systematic Reviews,
- Systematic Reviews with Metaanalysis,
- Guidelines,
- Practical Guidelines.

The result of this query was saved in the XML file.

Exported XML file was parsed by one-purpose PHP import script and selected data fields (title, authors, MeSH terms, abstract, unique identifier PMID, date of the

abstract publication in the MEDLINE database, link to the full text, journal title) were saved to the COR database.

The actualization of the COR database proceeds daily by an automatically started PHP script, which browse through an RSS channel of the PubMed database with the same query parameters as the original import script. The actualization script uses tools from the Entrez Programming Utilities [4] for gathering special data for each article, that are not part of the RSS channel.

2.2. The Web Interface of the COR

Contrary to the original PubMed interface we concentrated on the fastest way to reducing the number of search results preserving the focus on results important for the clinical practice.

Users can limit search results by one mouse-click to one category of EBM quality of evidence. Users can also use six form fields of the filter on the home page of the COR application for entering search criteria.

Figure 2: An example of COR application web interface showing the detail of an article record.

Individual form field stands for entering a part of text in the article title or abstract. Another form field specifies requested author or authors. The third large form field stands for entering parts or exact full terms of Medical Subject Headings (MeSH) thesaurus. Users can write down requested MeSH terms or they can choose them from a generated MeSH Cloud or MeSH List, where terms are displayed in relation to their appearance in articles or sorted alphabetically.

In these form fields it is possible to use logical operators AND and OR. It is also possible to use a dynamically generated autocomplete function in these three fields to simplify entering exact phrases.

Users can limit the list of search results by setting the lowest and the highest date of publishing the article in the MEDLINE database in next two form fields. The dates can be set manually or chosen from the javascript date picker.

The last form field stands for the manual choice of the category of EBM quality of evidence.

For the fast choice of most frequented MeSH terms and their insertion to the filter, there is a "MeSH cloud" in the right part of the application web page, where enlisted terms differ in the text size displaying frequency of each term in the database. Users can use the list of last search queries.

2.3. Search Results

The COR application displays search results matching entered parameters below the filter. Search results are in descending order sorted by the date of publication in the MEDLINE database. The simple list of results shows article title, names of authors and the date of publication in the MEDLINE database. There can be maximum of 15 results on one page, user can browse through the result pages. The EBM category of article can be differentiated by graphical icon.

By clicking on the article title in the list of results user can navigate to the detail page of the article record. The detail page shows the article title, names of authors, list of assigned MeSH terms, PMID identifier, link to the original record in the PubMed database, link to the full text of the article (if available in the Internet), article abstract, journal title and the date of publication in the MEDLINE database. The User of the COR application can rate the helpfulness of the article in the scale from one to five star symbols. This rating is linked to the IP address, so one user can rate a single article only one time. User can also attach a comment to the article.

2.4. Web 2.0 Social Functions

Second big task for the COR application is to allow easy sharing of clinically important search results with colleagues, friends and professional community. The detail of the article including abstract and bibliographical data can be shared via email, Facebook, Twitter and other social networks contained in the „Share this“ web service [5].

Excepting concrete scientific article detail, the COR offers an easy way to share a link to itself via Share this service, Facebook, Twitter, e-mail or one of 21 most common social and bookmarking services like Digg, Delicious, Reddit, Youhoo! od Google Bookmarks.

Users can follow COR own profiles at Facebook and Twitter, Blogger account and Youtube channel. Users can subscribe to RSS channels with last 20 articles or last 20 comments generally or individually for each EBM category of articles.

2.5. Future Plans and Improvements

We plan further improvements and simplifications in the web interface of the COR application in the future. One thing which can speed up using the filter and make the work more illustrative is to place a graphical slider and the time plot showing numbers of articles published in the discrete time periods and their selection in the filter.

Long term problem is to optimise the autocomplete function in three form fields in the filter to help users in inserting key terms in the easiest way. This process should be evaluated in the cooperation with common users.

Geotagging can help to make search results more regionally-oriented. Metadata contained in the PubMed database can show in which country the article was published. Geographical information in the field "Affiliation" is even more interesting. It is possible to find out where the article was created and what population is in

the article described. We can draw this information in the map or allow its limitation in the filter.

We assume an individualization of the web interface for registered users in the future development of the COR application. After the registration process and logging in user could browse the history of own search queries, create lists of favourite articles, let the system send him notification on some events in the database or define own RSS channels or add authorized comments and ratings.

The COR application not only can serve users of the web interface or RSS readers. By creating a XML data interface we can connect another information systems and send them search results or record details on their demands. Possible service for hospital information systems could be to offer relevant document for the concrete clinical situation defined by MeSH and geographical terms.

2.6. Discussion

Widely accepted PubMed database of biomedical citations has a free accessible web interface with a basic or advanced version of the search. We can use other web services for searching for scientific articles by clinical terms or other parameters. These services are more general (Google, Google Scholar) or focused on natural sciences (Scopus). Why create another search tool?

The amount of scientific articles indexed in electronic databases increase steeply. Recent question "where to find" will surrender to questions "how to search" and "how to search the easiest way". The COR offers simple and fast way how to search the PubMed database for articles in the field of Cardiology and with the focus on highest evidence. It copes only one thousandth of the PubMed database and provides easy-to-use tools for setting the search query, that can acquire small amount of articles appropriate to the clinical need.

There are another web services specialized on searching in large databases of scientific bibliography (<http://demos.vivisimo.com>, <http://www.tripdatabase.com>, <http://www.pubmeddy.com> - discontinued). The COR is unique in its focus on one domain (Cardiology), on few defined EBM categories most important for clinical practice and in the simplicity of use.

The key question for the progress of the COR application will be the interest of expert medical community. The COR contains tools for sharing scientific information between experts, tools for subjective rating of their quality and tools for expert discussion. Experts could be motivated by functions for registered users, in-

dividualized search functions, the ease of use and the fact, that this application is free of charge.

The COR application is designed specially for Cardiology. Filters used for extraction from the PubMed data-

base firmly defined. Same technology could be used for another one purpose (one expert domain) web portals. Similar filters could be also individually set for registered users, so the scope could be widened to another domains.

Name of service	Number of results
Google.com	approx. 66,000,000
Google.com last year	approx 288,000,000
Google Scholar	approx 1,700,000
Scopus	243,866
Scopus - only Health Sciences	179,511
PubMed	144,097
COR	1,695
COR - Practice Guidelines	79
COR - Pracice Guidelines in last 5 years	33

Table 1: Comparison of the number of search results in different web services - searching for the MeSH term "heart failure".

3. Conclusion

We created the Cardio Online Reader application for an easy search for clinical relevant scientific articles in the field of Cardiology. This application is freely accessible on <http://neo.euromise.cz/cor>. The PubMed database is the main data source for our application.

The application contains a filter consisted from six form fields. Search results are in descending order sorted by the date of publication in the MEDLINE database. The detail page shows the article title, names of authors, list of assigned MeSH terms, PMID identifier, link to the original record in the PubMed database, link to the full text of the article (if available in the Internet), article abstract, journal title and the date of publication in the MEDLINE database.

The COR application offers an easy access to services for content sharing as the "Share this" service, social and bookmarking services, comments and ratings and sharing via email.

References

- [1] A. Jinha, "Article 50 million: an estimate of the number of scholarly articles in existence", *Learned Publishing*, Vol. 23, No. 3, pp. 258-263, 2010.
- [2] "PubMed: MEDLINE Retrieval on the World Wide Web" United States National Library of Medicine 2002-06-07 <http://www.nlm.nih.gov/pubs/factsheets/pubmed.html>.
- [3] R. Smith, "What clinical information do doctors need?" *BMJ*, Vol. 313, No. 7064, pp. 1062-1068, 1996.
- [4] D. Wheeler, T. Barrett, D. Benson, S. Bryant, K. Canese, V. Chetvernin, D. Church, M. DiCuccio, R. Edgar, S. Federhen, L. Geer, Y. Kapustin, O. Khovayko, D. Landsman, D. Lipman, T. Madden, D. Maglott, J. Ostell, V. Miller, K. Pruitt, G. Schuler, E. Sequeira, S. Sherry, K. Sirotkin, A. Souvorov, G. Starchenko, R. Tatusov, T. Tatusova, L. Wagner, and E. Yaschenko, "Database resources of the National Center for Biotechnology Information", Oxford University Press, 2006.
- [5] ShareThis, <http://www.sharethis.com>.

Ústav informatiky AV ČR, v. v. i.
DOKTORANDSKÉ DNY '11

Vydal
MATFYZPRESS
vydavatelství
Matematicko-fyzikální fakulty
Univerzity Karlovy
Sokolovská 83, 186 75 Praha 8
jako svou – *not yet* – publikaci

Obálku navrhl František Hakl

Z předloh připravených v systému \LaTeX
vytisklo Repro středisko MFF UK
Sokolovská 83, 186 75 Praha 8

Vydání první

Praha 2011

ISBN – *not yet* –