



národní
úložiště
šedé
literatury

Verification of Electrical and Gravimetric Measurement of ELPI.

Ondráček, Jakub
2019

Dostupný z <http://www.nusl.cz/ntk/nusl-407888>

Dílo je chráněno podle autorského zákona č. 121/2000 Sb.

Tento dokument byl stažen z Národního úložiště šedé literatury (NUŠL).

Datum stažení: 15.06.2024

Další dokumenty můžete najít prostřednictvím vyhledávacího rozhraní nusl.cz .

VERIFICATION OF ELECTRICAL AND GRAVIMETRIC MEASUREMENT OF ELPI

Jakub ONDRÁČEK¹, Petr ROZTOČIL¹, Lucie ONDRÁČKOVÁ¹, Lucia VLČKOVÁ¹, Irena BENEŠOVÁ-ŠEVČÍKOVÁ¹, Věra PROCHÁZKOVÁ¹, Josef KUGLER¹, Petr OTÁHAL²

¹ ICPF, AS CR, v.v.i. Prague, Czech Republic, ondracek@icpf.cas.cz

² SÚJCHBO, v.v.i., Kamenná, Czech Republic, otahal@sujchbo.cz

Keywords: ELPI, Gravimetric and electrical measurement, Aerosol spectrometers

INTRODUCTION

Cascade impactors are widely used for gravimetric analysis of atmospheric aerosol with a great advantage of size resolved chemical composition. Another improvement of cascade impactor concept is represented by electrical cascade impactor – in our case Electrical Low Pressure Impactor (ELPI, Dekati). This device allows for measurements of deposits on individual impactor stages (gravimetric analysis) accompanied with high time resolution measurement of current induced by individual particles hitting the stages (electrical analysis). The idea of having highly time (up to 10 Hz) and commonly (for impactors) size resolved (14 stages) online measurement together with possibility of size resolved chemical composition is advantageous. On the other the measurement of the current induced by aerosol particles transformed into other physical quantities (such as particle number/volume/mass) is burdened with many artifact (multiple charging, image charges, etc.) and is not an easy task. This contribution compares the gravimetric and electrical measurement of ELPI impactor with traditional and very well-established aerosol spectrometers (SMPS, APS and CPC) on set of well-defined aerosols (different composition, sizes and morphology).

EXPERIMENTAL SETUP

The experiments conducted within this study included ELPI (14 stage electrical cascade impactor, 6 nm – 10 μm), SMPS (electrical mobility + single count scattering, 64 channels per decade, 14 – 700 nm), APS (time-of-flight aerodynamic sizing, 32 channels per decade, 0.5 – 20 μm) and CPC (single count scattering, 4.5 nm – 3 μm – total count). All the instruments were sampling from common dilution and homogenization sampling tubing using iso-kinetic subsampling concept (see Fig. 1, note that the horizontal/vertical arrangement in the picture is just illustrative) in order to have representative sample of generated aerosol comparable for all the instruments involved.

The particles used for testing included polydisperse aerosol: ammonium sulphate (AS, solid), sodium chloride (SC, solid), (DEHS, liquid with SC cores) and silver (Ag, solid); and monodisperse aerosol: AS with sizes selected in electrostatic classifier and polystyrene latex spheres (PSL, solid) – see the details in Tab. 1. The aerosol particles were generated using different aerosol generators (see Tab. 1 for details) and afterwards dried, cut with electrostatic classifier (only AS), and diluted before entering the aerosol sampling devices (see Fig. 1). Also a short study on RH influence on the ELPI results was conducted using SC particles with different degree of drying.

All the data were logged and the obtained results were compared emphasizing the shape of resulting size distributions.

Tab. 1: Characterization of testing well-defined aerosol particles + ELPI measurement.

Generator	Composition	GMD	GSD	ELPI method
		[nm, μ m]		
AGK 2000	AS (1 g/l), S, P	50	1.7	E+G
AGK 2000	AS (1 g/l), S, M	20, 50, 100, 200	1.2	E
AGK 2000	PSL, S, M	200, 1, 3	1.1	E+G
MAG3000	DEHS, L, M	0.7, 2, 2.6, 3.3, 4.1	1.7	E
Sea	SC (100 g/l), S, P	approx. 70	2.3	E+G
Furnace	Ag, S, P	30	1.5	E

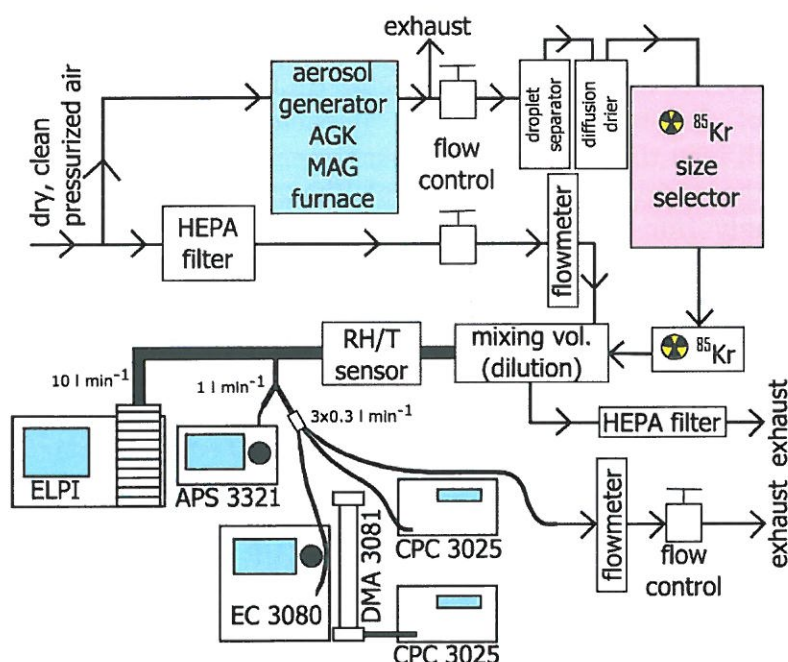

Fig. 1: Experimental set-up.

RESULTS AND CONCLUSIONS

The results of the comparison of ELPI performance against reference aerosol spectrometers on well-defined aerosol particles will be revealed during presentation of Jakub Ondráček. If you are interested, please come, watch, listen and ask (and the one who reads up to here can invite JO for drink or be invited?).

ACKNOWLEDGEMENT

This work was supported by the Ministry of Interior of the Czech Republic: VH20182021036 - Modern methods of detection and identification of dangerous CBRN compounds, methods for decreasing of their danger and decontamination, modern means of person's protection.